

CHAPTER 2

$$2-1. \quad e(t) = t; \quad E(z) = 0 + Tz^{-1} + 2Tz^{-2} + \dots = \frac{Tz}{(z-1)^2}$$

$$2-2. \quad (a) \quad E(z) = 1 + e^{-T}z^{-1} + e^{-2T}z^{-2} + \dots \\ = 1 + (e^{-T}z^{-1})' + (e^{-T}z^{-1})^2 + \dots = \frac{1}{1 - e^{-T}z^{-1}} = \frac{z}{z - e^{-T}}$$

$$(b) \quad E(z) = 1 + (0.9512z^{-1})' + (0.9512z^{-1})^2 + \dots$$

$$= \frac{z}{z - 0.9512}$$

$$(c) \quad e^{-bT} \Big|_{T=0.2} = e^{-0.2b} = 0.5$$

$$\therefore -0.2b = \ln(0.5) = -0.6931 \Rightarrow b = \underline{-3.466}$$

$$2-3. \quad (a) \quad e(t) = e^{-at} \Rightarrow E(z) = 1 + e^{-aT}z^{-1} + e^{-2aT}z^{-2} + \dots = \frac{z}{z - e^{-aT}}$$

$$(b) \quad e(t) = e^{-(t-T)} u(t-T)$$

$$E(z) = z^{-1} + e^{-T}z^{-2} + e^{-2T}z^{-3} + \dots = z^{-1} \left[\frac{z}{z - e^{-T}} \right] = \frac{1}{z - e^{-T}}$$

$$(c) \quad e(t) = e^{-(t-5T)} u(t-5T)$$

$$E(z) = z^{-5} + e^{-T}z^{-6} + e^{-2T}z^{-7} + \dots = z^{-5} \left[\frac{z}{z - e^{-T}} \right] = \frac{1}{z^4(z - e^{-T})}$$

$$2-4. \quad E_1(s) = \frac{z}{s(s+z)} = \frac{1}{s} + \frac{-1}{s+z}$$

$$\therefore e_1(t) = (1 - e^{-zt}) u(t) \Rightarrow e_1(kT) = (1 - e^{-2kT}) u(kT)$$

$$\therefore E_1(z) = (1 + z^{-1} + z^{-2} + \dots) - (1 - e^{-2T}z^{-1} + e^{-4T}z^{-2} + \dots)$$

$$= \frac{1}{1 - z^{-1}} - \frac{1}{1 - e^{-2T}z^{-1}} = \frac{z}{z-1} - \frac{z}{z - e^{-2T}} = \frac{(1 - e^{-2})z}{(z-1)(z - e^{-2})}, T=1$$

$$E(z) = E_1(z) - z^{-5}E_1(z) = \frac{(1 - e^{-2})(z^5 - 1)}{z^4(z-1)(z - e^{-2})} = \frac{0.8647(z^5 - 1)}{z^4(z-1)(z - 0.1353)}$$

$$2-5. \quad (a) \quad e(k) = \sum_{\text{residues } z(z-0.9)} \frac{0.1z^{k-1}}{z(z-0.9)} = \sum_{\text{residues } z-0.9} \frac{0.1z^{k-2}}{z-0.9}$$

$$2-5.(a) \quad k=0: fcn = \frac{0.1}{z^2(z-0.9)}, \quad \therefore \text{residue} \Big|_{z=0.9} = \frac{0.1}{(0.9)^2} = \underline{0.1235}$$

$$\text{residue} \Big|_{z=0} = \frac{d}{dz} \left[\frac{0.1}{z-0.9} \right] \Big|_{z=0} = \frac{-0.1(1)}{(z-0.9)^2} \Big|_{z=0} = \frac{-0.1}{(0.9)^2} = \underline{-0.1235}$$

$$\therefore e(0) = \underline{0}$$

$$k=1: e(1) = \frac{0.1}{z-0.9} \Big|_{z=0} + \frac{0.1}{z} \Big|_{z=0.9} = \underline{0}$$

$$k=10: e(10) = \underline{0.1(0.9)^8}$$

$$(b) \quad e(0) = \lim_{z \rightarrow \infty} E(z) = \lim_{z \rightarrow \infty} \frac{0.1}{z^2(z-0.9)} = \underline{0}$$

$$(c) \quad \frac{E(z)}{z} = \frac{0.1}{z^2(z-0.9)} = \frac{k_1}{z^2} + \frac{k_2}{z} + \frac{k_3}{z-0.9}$$

$$k_1 = \frac{-0.1}{0.9} = \underline{-\frac{1}{9}}; \quad k_3 = \frac{0.1}{(0.9)^2} = \underline{\frac{1}{8.1}}$$

$$k_2 = \frac{d}{dz} \left[\frac{0.1}{z-0.9} \right] \Big|_{z=0} = \underline{\frac{-1}{8.1}}, \text{ from (a)}$$

$$\therefore e(k) = \frac{-1}{8.1} \delta(k) - \frac{1}{9} \delta(k-1) + \frac{1}{8.1} (0.9)^k$$

$$x(0) = \frac{-1}{8.1} + 0 + \frac{1}{8.1} = \underline{0}; \quad x(1) = -0 - \frac{1}{9} + \frac{0.9}{8.1} = \underline{0}$$

$$x(10) = -0 - 0 + \frac{0.1}{(0.9)^2} (0.9)^{10} = \underline{0.1(0.9)^8}$$

$$(d) \quad E(z) = \frac{1.98z}{z^5 + \dots} = 1.98z^{-4} + (\cdot)z^{-5} + (\cdot)z^{-6} + \dots$$

$$\therefore e(0) = e(1) = e(2) = e(3) = \underline{0}; \quad e(4) = \underline{1.98}$$

$$(e) \quad E(z) = \frac{2z}{z-0.8} = \frac{2z}{z-e^{-aT}} \quad \therefore e^{-aT} = 0.8 \Rightarrow aT = 0.2231$$

$$\therefore a = \frac{0.2231}{0.1} = 2.231, \quad \therefore e(t) = \underline{2e^{-2.231t} u(t)}$$

$$(f) \quad E(z) = \frac{2z}{z-(0.8)}; \quad \therefore e^{-aT} e^{j\pi} = -0.8 \Rightarrow aT = 2.231$$

$$\therefore e(t) = \underline{2e^{-2.231t} \cos 10\pi t} \text{ where } \frac{\omega_s}{2} = 10\pi$$

$$(g) \quad (e) \quad e(k) = (0.8)^k; \quad (f) \quad e(k) = (-0.8)^k$$

\therefore sign alternates on $e(k)$.

$$2-6.(a) \mathcal{Z}[e^{(t-2T)}u(t-2T)] = \frac{(z^3 - 2z)z^{-2}}{z^4 - 0.9z^2 + 0.8}$$

$$(b) e(0) = 0, e(1) = 1$$

$$\begin{aligned} \therefore \mathcal{Z}[e^{(t+T)}u(t)] &= z[E(z) - e(0) - e(1)z^{-1}] \\ &= z\left[\frac{z^3 - 2z}{z^4 - 0.9z^2 + 0.8} - \frac{1}{z}\right] = \frac{-1.1z^2 + 0.8}{z^4 - 0.9z^2 + 0.8} \end{aligned}$$

$$\begin{aligned} (c) \mathcal{Z}[e^{(t-T)}u(t-2T)] &= e(T)z^{-2} + e(2T)z^{-3} + \dots \\ &= z^{-1}[E(z) - e(0)] = z^{-1}E(z), \text{ since } e(0) = 0 \\ &= \frac{z^2 - z}{z^4 - 0.9z^2 + 0.8} \end{aligned}$$

$$2-7.(a) e(\infty) = \lim_{z \rightarrow 1} (z-1)E(z) = \frac{z(z-1)}{(z+1)^2} \Big|_{z=1} = 0$$

$$(b) e(k) = \mathcal{Z}^{-1}\left[\frac{z}{(z-1)^2}\right] = k(-1)^k, \therefore e(\infty) \text{ unbounded}$$

$$(c) (a) e(\infty) = \lim_{z \rightarrow 1} (z-1)\frac{z}{(z-1)^2}, \therefore \text{unbounded}$$

$$(b) e(k) = k, \therefore \text{unbounded}$$

$$(d) (a) e(\infty) = \lim_{z \rightarrow 1} (z-1)\frac{z}{(z-0.9)^2} = 0$$

$$(b) e(k) = k(0.9)^k; \therefore e(\infty) \rightarrow 0$$

$$(e) (a) e(\infty) = \lim_{z \rightarrow 1} (z-1)\frac{z}{(z-1.1)^2} = 0$$

$$(b) e(k) = k(1.1)^k; \therefore e(\infty) \text{ is unbounded.}$$

$$2-8.(a) i) z^2 - 1.6z + 0.6 \left) \begin{array}{r} 0.5z^{-1} + 0.8z^{-2} + 0.98z^{-3} + \dots \\ 0.5z \\ \hline 0.5z - 0.8 + 0.3z^{-1} \\ \hline 0.8 - 0.3z^{-1} \\ \hline 0.8 - 1.28z^{-1} + \dots \\ \hline 0.98z^{-1} + \dots \end{array}$$

$$ii) \frac{E(z)}{z} = \frac{0.5}{(z-1)(z-0.6)} = \frac{1.25}{z-1} + \frac{-1.25}{z-0.6}; \therefore E(z) = \frac{1.25z}{z-1} - \frac{1.25z}{z-0.6}$$

$$\therefore e(k) = \underline{1.25(1 - 0.6^k)u(k)}$$

$$iii) z^{k-1}E(z) = \frac{0.5z^k}{(z-1)(z-0.6)}$$

$$e(k) = \frac{0.5(1)^k}{1-0.6} + \frac{0.5(0.6)^k}{0.6-1} = \underline{1.25(1-0.6^k)u(k)}$$

$$(iv) E_1(z) = \frac{0.5z}{z-0.6} \Rightarrow e_1(k) = 0.5(0.6)^k$$

$$E_2(z) = \frac{1}{z-1} \Rightarrow e_2(0) = 0; e_2(k) = 1, k \geq 1$$

$$e(0) = e_1(0)e_2(0) = (0.5)(0) = \underline{0}$$

$$e(1) = e_1(1)e_2(1) + e_1(1)e_2(0) = (0.5)(1) + (0.5)(0) = \underline{0.5}$$

$$e(2) = e_1(2)e_2(2) + e_1(1)e_2(1) + e_1(0)e_2(0)$$

$$= 0.5 \times 1 + 0.3 \times 1 + 0.18 \times 0 = \underline{0.8}$$

$$e(3) = 0.5 \times 1 + 0.3 \times 1 + 0.18 \times 1 + 0.108 \times 0 = \underline{0.98}$$

$$(b) e(0) = 0$$

$$e(k) = 1.25 - 2.083(0.6)^k, k \geq 1$$

$$E(z) = \underline{0.5z^{-2} + 0.8z^{-3} + 0.98z^{-4} + 1.088z^{-5} + \dots}$$

$$(c) e(0) = 0; e(k) = 2.5 - 3.33(0.6)^k, k \geq 1$$

$$E(z) = \underline{0.5z^{-1} + 1.30z^{-2} + 1.78z^{-3} + 2.068z^{-4} + 2.2408z^{-5} + \dots}$$

$$(d) e(k) = 0.75 + 0.25(0.6)^k$$

$$E(z) = \underline{1 + 0.9z^{-1} + 0.84z^{-2} + 0.804z^{-3} + \dots}$$

$$(e) \text{ num} = [0 \ 0 \ 0.5];$$

$$\text{den} = [1 \ -1.6 \ 0.6];$$

$$[r, p, k] = \text{residue}(\text{num}, \text{den})$$

$$2-9. (a) \text{ poles: } z = \frac{2 \cos a \pm \sqrt{4 \cos^2 a - 4}}{2} = \underline{\cos a \pm j \sin a}$$

$$\therefore \text{pole} = \cos a, \text{ provided } \sin a = 0 \Rightarrow a = 0, \pm\pi, \pm2\pi, \dots, \pm n\pi$$

$$\text{Then } \cos a = (-1)^n \therefore \text{poles} = \underline{\cos a}$$

$$(b) E(z) = \frac{z(z - \cos a)}{(z - \cos a)(z - \cos a)} = \frac{z}{z - \cos a}, a = \pm n\pi, n = 0, 1, \dots$$

$$(c) E(z) = \frac{z}{z - \cos a} = \frac{z}{z - 1}, \therefore \underline{\cos a = 1}, a = 0, \pm 2\pi, \pm 4\pi, \dots$$

$$2-10. x(k) - 3x(k-1) + 2x(k-2) = e(k), e(k) = \begin{cases} 1, & k=0, 1 \\ 0, & k \geq 2 \end{cases}$$

$$(a) x(0) = e(0) = 1$$

$$x(1) = e(1) + 3x(0) = 4$$

$$2-10. (a) \quad x(2) = e(2) + 3x(1) - 2x(0) = 10$$

$$x(3) = 0 + 3x(2) - 2x(1) = 22$$

$$x(4) = 0 + 3x(3) - 2x(2) = 46$$

$$(b) \quad [1 - 3z^{-1} + 2z^{-2}]X(z) = E(z) = 1 + z^{-1} = \frac{z+1}{z}$$

$$X(z) = \frac{z^2}{(z-1)(z-2)} \times \frac{z+1}{z} = \frac{z(z+1)}{(z-1)(z-2)} = z \left[\frac{-2}{z-1} + \frac{3}{z-2} \right]$$

$$\therefore x(k) = \underline{-2 + 3(2)^k}$$

(c) No, since the final value does not exist.

$$2-11. (a) \quad E(z) = \mathcal{Z}[u(k-1)] = z^{-1} \left[\frac{z}{z-1} \right] = \frac{1}{z-1}$$

$$[z^2 - \frac{3}{4}z + \frac{1}{8}]Y(z) = E(z)$$

$$\frac{Y(z)}{z} = \frac{1}{z(z-\frac{1}{2})(z-\frac{1}{4})} \cdot \frac{1}{z-1} = \frac{-8}{z} + \frac{8/3}{z-1} + \frac{-16}{z-1/2} + \frac{64/3}{z-1/4}$$

$$\therefore y(k) = \underline{-8\delta(k) + \frac{8}{3} - 16(\frac{1}{2})^k + \frac{64}{3}(\frac{1}{4})^k}$$

$$\therefore y(0) = \underline{0} ; y(1) = \underline{0} ; y(2) = \underline{0} ; y(3) = \underline{1} ; y(4) = \underline{\frac{7}{4}}$$

$$(b) \quad y(k+2) = e(k) + \frac{3}{4}y(k+1) - \frac{1}{8}y(k)$$

$$y(2) = 0 + \frac{3}{4}(0) - \frac{1}{8}(0) = \underline{0}$$

$$y(3) = 1 + \frac{3}{4}(0) - \frac{1}{8}(0) = \underline{1}$$

$$y(4) = 1 + \frac{3}{4}(1) - \frac{1}{8}(0) = \underline{7/4}$$

$$(c) (a) \quad y(k+2) - \frac{3}{4}y(k+1) + \frac{1}{8}y(k) = 0$$

$$\therefore z^2 [Y(z) - y(0) - y(1)z^{-1}] - \frac{3}{4}z[Y(z) - y(0)] + \frac{1}{8}Y(z) = 0$$

$$\therefore [z^2 - \frac{3}{4}z + \frac{1}{8}]Y(z) = z^2 - 2z - \frac{3}{4}z$$

$$\therefore Y(z) = z \left[\frac{z^{-1/4}}{(z-1/2)(z-1/4)} \right] = z \left[\frac{-9}{z-1/2} + \frac{10}{z-1/4} \right] \Rightarrow y(k) = \underline{-9(\frac{1}{2})^k + 10(\frac{1}{4})^k}$$

$$y(0) = \underline{1}, y(1) = \underline{-2}, y(2) = \underline{-13/8}, y(3) = \underline{-31/32}, y(4) = \underline{-67/128}$$

$$(b) \quad y(k+2) = \frac{3}{4}y(k+1) - \frac{1}{8}y(k)$$

$$y(2) = \frac{3}{4}(-2) - \frac{1}{8}(1) = \underline{-13/8}$$

$$y(3) = \frac{3}{4}(-\frac{13}{8}) - \frac{1}{8}(-2) = \underline{-31/32}$$

$$y(4) = \frac{3}{4}(-\frac{31}{32}) - \frac{1}{8}(-\frac{13}{8}) = \underline{-67/128}$$

$$2-12.(a) [1 - z^{-1} + z^{-2}]X(z) = E(z) = \frac{z}{z-1}$$

$$X(z) = \frac{z^3}{(z-1)(z^2-z+1)}, \quad \text{poles: } z = \frac{1}{2} \pm j\frac{\sqrt{3}}{2} = 1 \angle \pm 60^\circ$$

$$\frac{X(z)}{z} = \frac{1}{z-1} + \frac{k_1}{z-p_1} + \frac{k_1^*}{z-p_1^*} \quad \text{with } p = 1 \angle 60^\circ$$

$$k_1 = \left. \frac{z^2}{(z-1)(z-1 \angle 60^\circ)} \right|_{z=1 \angle 60^\circ} = \frac{1 \angle 120^\circ}{(1.5 + j.866 - 1)(1.5 + j.866 - 1 + j.866)}$$

$$= \frac{1 \angle 120^\circ}{1 \angle 120^\circ [j 2(0.866)]} = 0.5774 \angle -90^\circ$$

$$\therefore aT = \ln |p_1| = 0; \quad bT = \arg p_1 = \frac{\pi}{3}$$

$$A = 2|k_1| = 1.155; \quad \theta = \arg k_1 = -90^\circ$$

$$\therefore x(k) = 1 + 1.155 \cos\left(\frac{\pi}{3}k - 90^\circ\right) = 1 + 1.155 \sin\left(\frac{\pi}{3}k\right)$$

$$\therefore x(0) = 1, \quad x(1) = 2, \quad x(2) = 2$$

$$(b) \begin{array}{r} z^3 - 2z^2 + 2z - 1 \overline{) z^3} \\ \underline{z^3 - 2z^2 + 2z - 1} \\ 2z^2 - 2z + 1 \\ \underline{2z^2 - 4z + 4 - 2z^{-1}} \\ 2z + \dots \end{array} \quad \begin{array}{l} \therefore x(0) = 1 \\ x(1) = 2 \\ x(2) = 2 \end{array}$$

$$(c) x(k) = 1 + x(k-1) - x(k-2)$$

$$x(0) = 1 + 0 - 0 = 1$$

$$x(1) = 1 + 1 - 0 = 2$$

$$x(2) = 1 + 2 - 1 = 2$$

(d) No, 3 poles for $X(z)$ on the unit circle.

$$2-13.(a) z^2[X(z) - x(0) - x(1)z^{-1}] + 3z[X(z) - x(0)] + 2X(z) = E(z) = 1$$

$$\therefore X(z) = \frac{1 + z^2 - z + 3z}{z^2 - 3z + 2} = \frac{z^2 + 2z + 1}{z^2 + 3z + 2} = \frac{z+1}{z+2}$$

$$\therefore X(z) = z \left[\frac{z+1}{z(z+2)} \right] = z \left[\frac{1/2}{z} + \frac{1/2}{z+2} \right]$$

$$\therefore x(k) = \frac{1}{2} \delta(k) + \frac{1}{2} (-2)^k$$

2-13.(b) $x(0) = \underline{1}$, $x(1) = \underline{-1}$, $x(2) = \underline{2}$, $x(3) = \underline{-4}$

(c)
$$\begin{array}{r} 1 - z^{-1} + 2z^{-2} - 4z^{-3} + \dots \\ z+2 \overline{) z+1} \\ \underline{z+2} \\ -1 \\ -1 - 2z^{-1} \\ \underline{2z^{-1}} \\ 2z^{-1} + 4z^{-2} \\ \underline{-4z^{-2}} \\ \dots \end{array}$$

(d) $x(k+2) = e(k) - 3x(k+1) - 2x(k)$
 $x(2) = 1 - 3(-1) - 2(1) = \underline{2}$
 $x(3) = 0 - 3(2) - 2(-1) = \underline{-4}$

2-14.(a)

```
x0 = 0;
x1 = 0;
x2 = 0;
for k = 0:5;
    x3 = 2.2*x2 - 1.57*x1 + 0.36*x0 + 1;
    x0 = x1;
    x1 = x2;
    x2 = x3;
end
```

(b) $x(k+3) = e(k) + 2.2x(k+2) - 1.57x(k+1) + 0.36x(k)$
 $x(3) = 1 + 0 - 0 + 0 = \underline{1}$
 $x(4) = 1 + 2.2(1) - 0 + 0 = \underline{3.2}$
 $x(5) = 1 + 2.2(3.2) - 1.57(1) = \underline{6.47}$

(c) $[z^3 - 2.2z^2 + 1.57z - 0.36]X(z) = E(z) = \frac{z}{z-1}$

$$X(z) = \frac{z}{(z-1)(z^3 - 2.2z^2 + 1.57z - 0.36)}$$

$$\begin{array}{r} z^4 - 3.2z^3 + 3.77z^2 - 1.93z + 0.36 \overline{) z} \\ \underline{z} \\ z^{-3} + 3.2z^{-4} + 6.47z^{-5} + \dots \\ \underline{z} \\ z^{-3} - 3.2 + 3.77z^{-1} \dots \\ \underline{3.2 - 3.77z^{-1}} \\ 3.2 - 10.24z^{-1} + \dots \\ \underline{6.47z^{-1} - 4 \dots} \\ \dots \end{array}$$

$\therefore x(3) = \underline{1}$
 $x(4) = \underline{3.2}$
 $x(5) = \underline{6.47}$

2-15.(a) $y(k+1) = y(k) + Tx(k)$

(b) $zY(z) = Y(z) + TX(z) \Rightarrow \frac{Y(z)}{X(z)} = \frac{T}{z-1}$

$$2-15. (c) \quad y(k+1) = y(k) + T x(k+1)$$

$$(d) \quad zY(z) = Y(z) + TzX(z) \Rightarrow \frac{Y(z)}{X(z)} = \frac{Tz}{z-1}$$

$$(e) \quad y(1) = y(0) + Tx(0)$$

$$y(2) = y(1) + Tx(1) = y(0) + T(x(0) + x(1))$$

$$y(3) = y(2) + Tx(2) = y(0) + T[x(0) + x(1) + x(2)]$$

$$\therefore y(k) = y(0) + T \sum_{n=0}^{k-1} x(n)$$

$$(f) \quad y(1) = y(0) + Tx(1)$$

$$y(2) = y(1) + Tx(2) = y(0) + T[x(1) + x(2)]$$

$$\therefore y(k) = y(0) + T \sum_{n=1}^k x(n)$$

$$2-16. (a) \quad y(k+1) = y(k) + T \frac{x(k) + x(k+1)}{2}$$

$$(b) \quad zY(z) = Y(z) + \frac{T}{2}[X(z) + zX(z)] \Rightarrow Y(z) = \frac{T}{2} \frac{z+1}{z-1} X(z)$$

$$2-17. (a) \quad TzW(z) = zX(z) - X(z)$$

$$w(k+1) = \frac{1}{T}[x(k+1) - x(k)]$$

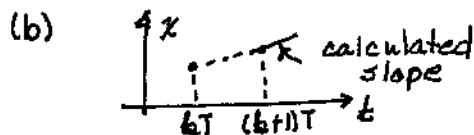

$$(c) \quad TW(z) = zX(z) - X(z)$$

$$w(k) = \frac{1}{T}[x(k+1) - x(k)]$$

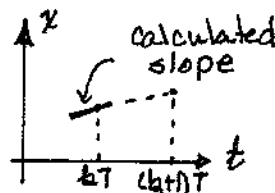

$$2-18. (a) \quad y(k) = \beta_2 e(k) + \beta_1 e(k-1) + \beta_0 e(k-2) - \alpha_1 y(k-1) - \alpha_0 y(k-2)$$

$$(b) \quad [1 + \alpha_1 z^{-1} + \alpha_0 z^{-2}] Y(z) = [\beta_2 + \beta_1 z^{-1} + \beta_0 z^{-2}] E(z)$$

$$\frac{Y(z)}{E(z)} = \frac{\beta_2 z^2 + \beta_1 z + \beta_0}{z^2 + \alpha_1 z + \alpha_0}$$

$$(c) \quad f(k) = e(k) - \alpha_1 f(k-1) - \alpha_0 f(k-2)$$

$$y(k) = b_2 f(k) + b_1 f(k-1) + b_0 f(k-2)$$

$$(d) \quad F(z) = E(z) - (\alpha_1 z^{-1} + \alpha_0 z^{-2}) F(z) \Rightarrow F(z) = \frac{E(z)}{1 + \alpha_1 z^{-1} + \alpha_0 z^{-2}}$$

$$2.18.(d) Y(z) = (b_2 + b_1 z^{-1} + b_0 z^{-2}) F(z) = \frac{b_2 z^2 + b_1 z + b_0}{z^2 + a_1 z + a_0} E(z)$$

(e) $\underline{\alpha_i = a_i}$ and $\underline{\beta_i = b_i}$, $i = 1, 2$

(f)

```

ykminus2 = 0;
ykminus1 = 0;
ekminus2 = 0;
ekminus1 = 0;
ek = 1;
for k = 0:5
    yk=b2*ek+b1*ekminus1+b0*ekminus2-a1*ykminus1-a0*ykminus2;
    [k, ek, yk]
    ekminus2 = ekminus1;
    ekminus1 = ek;
    ykminus2 = ykminus1;
    ykminus1 = yk;
end

```

(g)

```

fkminus2 = 0;
fkminus1 = 0;
ek = 1;
for k = 0:5
    fk=ek-a1*fkminus1-a0*fkminus2;
    yk = b2*fk+b1*fkminus1+b0*fkminus2;
    [k, ek, yk]
    fkminus2 = fkminus1;
    fkminus1 = fk;
end

```

$$2-19.(a) f_1(k) = g_1 f_1(k-1) - g_2 f_2(k-1) + g_3 e(k)$$

$$f_2(k) = g_1 f_2(k-1) + g_2 f_1(k-1) + g_4 e(k)$$

$$y(k) = b_0 e(k) + f_2(k-1)$$

$$(b) (1) F_1(z) = g_1 z^{-1} F_1(z) - g_2 z^{-1} F_2(z) + g_3 E(z)$$

$$(2) F_2(z) = g_1 z^{-1} F_2(z) + g_2 z^{-1} F_1(z) + g_4 E(z)$$

$$(3) Y(z) = b_0 E(z) + z^{-1} F_2(z)$$

$$\therefore (1) (z - g_1) F_1(z) + g_2 F_2(z) = g_3 z E(z)$$

$$(2) -g_2 F_1(z) + (z - g_1) F_2(z) = g_4 z E(z)$$

$$\therefore F_2(z) = \frac{\begin{vmatrix} z - g_1 & g_3 z E(z) \\ -g_2 & g_4 z E(z) \end{vmatrix}}{\begin{vmatrix} z - g_1 & g_2 \\ -g_2 & z - g_1 \end{vmatrix}} = \frac{(g_4 z^2 - g_1 g_4 z + g_2 g_3 z)}{(z - g_1)^2 + g_2^2} E(z)$$

$$2.19. (b) \therefore \frac{Y(z)}{E(z)} = b_2 + \frac{g_4 z^2 + g_2 g_3 - g_1 g_4}{(z - g_1)^2 + g_2^2}$$

$$\begin{aligned} \text{Also, } D(z) &= b_2 + \frac{\operatorname{Re}(A) + j \operatorname{Im}(A)}{z - \operatorname{Re}(P) - j \operatorname{Im}(P)} + \frac{\operatorname{Re}(A) - j \operatorname{Im}(A)}{z - \operatorname{Re}(P) + j \operatorname{Im}(P)} \\ &= b_2 + \frac{\frac{1}{2}(g_4 - j g_3)}{z - g_1 - j g_2} + \frac{\frac{1}{2}(g_4 + j g_3)}{z - g_1 + j g_2} \\ &= b_2 + \frac{g_4 z^2 - g_1 g_4 + g_2 g_3}{(z - g_1)^2 + g_2^2} \end{aligned}$$

$$\begin{aligned} (c) D(z) &= b_0 + \frac{g_2 g_3 z^{-2} + g_4 (1 - g_1 z^{-1})}{1 - g_1 z^{-1} - g_1 z^{-1} + g_1^2 z^{-2} + g_2^2 z^{-2}} \\ &= b_0 + \frac{g_4 z^2 + g_2 g_3 - g_1 g_4}{z^2 - 2g_1 z + g_1^2 + g_2^2} \end{aligned}$$

(d)

```
f1kminus1 = 0;
f2kminus1 = 0;
ek = 1;
for k = 0:5
    yk = b0*ek+f2kminus1;
    [k, ek, yk]
    f1k = g1*f1kminus1 - g2*f2kminus1 + g3*ek;
    f2k = g1*f2kminus1 + g2*f1kminus1 + g3*ek;
    f1kminus1 = f1k;
    f2kminus1 = f2k;
end
```

$$2-20 (a) \beta_2 = 2, \beta_1 = -2.4, \beta_0 = 0.72, \alpha_1 = -1.4, \alpha_0 = 0.98$$

$$(b) b_2 = 2, b_1 = -2.4, b_0 = 0.72, a_1 = -1.4, a_0 = 0.98$$

$$(c) \text{poles: } z = \frac{1.4 \pm (1.4^2 - 4(0.98))^{\frac{1}{2}}}{2} = 0.7 \pm j 0.7 = 0.99 \angle \pm 45^\circ$$

$$D(z) = 2 + \frac{A}{z - 0.7 - j 0.7} + \frac{A^*}{z - 0.7 + j 0.7}$$

$$\therefore A = \frac{z^2 - 2.4z + 0.72}{z - 0.7 + j 0.7} \Big|_{z=0.99 \angle 45^\circ} = \frac{j 1.96 - (1.68 + j 1.68) + 0.72}{j 1.4}$$

$$= \underline{0.2 + j 0.6857}$$

$$\therefore \begin{array}{ll} g_1 = 0.7 & g_3 = 1.371 \\ g_2 = 0.7 & g_4 = 0.4 \end{array}$$

2-20. (d) num=[2 -2.4 .72];
 den=[1 -1.4 0.98];
 [r,p,k]=residue(num,den)

$$(e) \Delta = 1 - (0.7z^{-1} + 0.7z^{-1} + 0.4z^{-2}) + 0.49z^{-2}$$

$$= 1 - 1.4z^{-1} + 0.98z^{-2}$$

$$D(z) = 2 + \frac{1}{\Delta} [1.371(0.7)z^{-2} + 0.4z^{-1}(1+0.7z^{-1})]$$

$$= 2 + \frac{0.4z - 1.24}{z^2 - 1.4z + 0.98} = \frac{2z^2 - 2.4z + 0.72}{z^2 - 1.4z + 0.98}$$

2-21.
 s1 = 0;
 e = 0;
 for k=0:5
 s2 = e - s1;
 m = 0.5*s2 - s1;
 [k,m]
 s1 = s2;
 e = e + 1;
 end

2-22. (a) $\frac{Y(z)}{U(z)} = \frac{2}{z^2 + 6z + 5}$

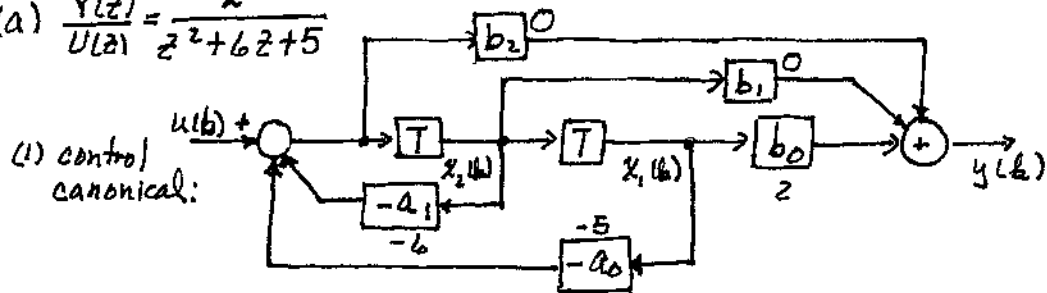

$$\underline{x}(k+1) = \begin{bmatrix} 0 & 1 \\ -5 & -6 \end{bmatrix} \underline{x}(k) + \begin{bmatrix} 0 \\ 1 \end{bmatrix} u(k)$$

$$y(k) = [2 \quad 0] \underline{x}(k)$$

(2) observer canonical:

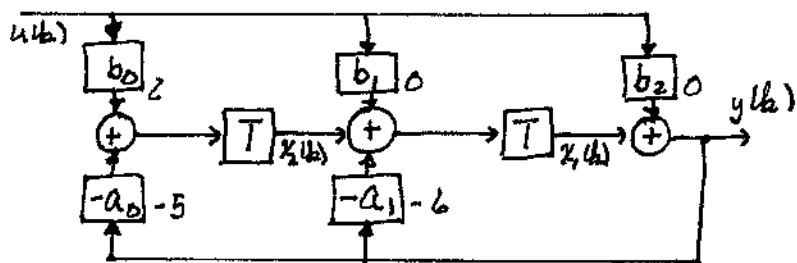

$$\underline{x}(k+1) = \begin{bmatrix} -6 & 1 \\ -5 & 0 \end{bmatrix} \underline{x}(k) + \begin{bmatrix} 0 \\ 2 \end{bmatrix} u(k)$$

$$y(k) = [1 \quad 0] \underline{x}(k)$$

2-22. (b) $\frac{Y(z)}{U(z)} = \frac{z+2}{z^2+6z+5}$ (1) control Canonical: $x(k+1) = \text{same as (a)}$
 $y(k) = [2 \quad 1]x(k)$

(2) observer canonical:

$$x(k+1) = \begin{bmatrix} -6 & 1 \\ -5 & 0 \end{bmatrix} x(k) + \begin{bmatrix} 1 \\ 2 \end{bmatrix} u(k)$$

$$y(k) = [1 \quad 0] x(k)$$

(c) $\frac{Y(z)}{U(z)} = \frac{3z^2+z+2}{z^2+6z+5}$ (1) control Canonical: $x(k+1) = \text{same as (a)}$
 $y(k) = [-13 \quad -17]x(k) + 3u(k)$

(2) observer canonical:

$$x(k+1) = \begin{bmatrix} -4 & 1 \\ -5 & 0 \end{bmatrix} x(k) + \begin{bmatrix} 1 \\ 2 \end{bmatrix} u(k)$$

$$y(k) = [1 \quad 0] x(k) + 3u(k)$$

2-23. (a) $G(z) = G_1(z)G_2(z) = \frac{z}{z^2-z} = \frac{zz^{-2}}{1-z^{-1}}$

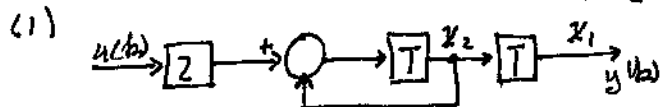

$$x(k+1) = \begin{bmatrix} 0 & 1 \\ 0 & 1 \end{bmatrix} x(k) + \begin{bmatrix} 0 \\ 2 \end{bmatrix} u(k)$$

$$y(k) = [1 \quad 0] x(k)$$

(2) $G(z) = \frac{z}{z(z-1)} = \frac{-2}{z} + \frac{z}{z-1} = G_1(z) + G_2(z)$

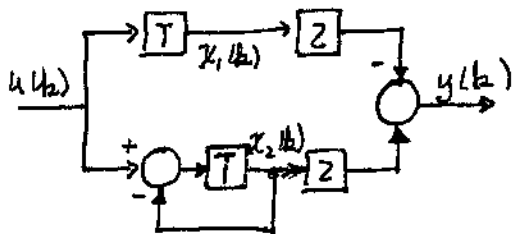

$$x(k+1) = \begin{bmatrix} 0 & 0 \\ 0 & 1 \end{bmatrix} x(k) + \begin{bmatrix} 1 \\ 1 \end{bmatrix} u(k)$$

$$y(k) = [-2 \quad 2] x(k)$$

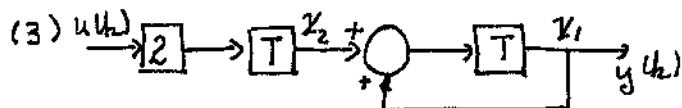

$$x(k+1) = \begin{bmatrix} 1 & 1 \\ 0 & 0 \end{bmatrix} x(k) + \begin{bmatrix} 0 \\ 2 \end{bmatrix} u(k)$$

$$y(k) = [1 \quad 0] x(k)$$

$$2-23(b) (1) \quad zI-A = \begin{bmatrix} z & -1 \\ 0 & z-1 \end{bmatrix}; \quad |zI-A| = z^2 - z = \Delta$$

$$G(z) = C(zI-A)^{-1}B = \frac{1}{\Delta} [1 \ 0] \begin{bmatrix} z-1 & 1 \\ 0 & z \end{bmatrix} \begin{bmatrix} 0 \\ z \end{bmatrix} = \frac{1}{\Delta} [z-1 \ 1] \begin{bmatrix} 0 \\ z \end{bmatrix} = \frac{z}{z(z-1)}$$

$$(2) \quad zI-A = \begin{bmatrix} z & 0 \\ 0 & z-1 \end{bmatrix}; \quad |zI-A| = \Delta = z^2 - z$$

$$G(z) = C(zI-A)^{-1}B = \frac{1}{\Delta} [1 \ 1] \begin{bmatrix} z-1 & 0 \\ 0 & z \end{bmatrix} \begin{bmatrix} z \\ z \end{bmatrix} = \frac{1}{\Delta} [1 \ 1] \begin{bmatrix} z^2 - z \\ z^2 \end{bmatrix} = \frac{z}{z(z-1)}$$

$$(3) \quad zI-A = \begin{bmatrix} z-1 & -1 \\ 0 & z \end{bmatrix}; \quad |zI-A| = z^2 - z = \Delta$$

$$G(z) = C(zI-A)^{-1}B = \frac{1}{\Delta} [1 \ 0] \begin{bmatrix} z & 1 \\ 0 & z-1 \end{bmatrix} \begin{bmatrix} 0 \\ z \end{bmatrix} = \frac{1}{\Delta} [z \ 1] \begin{bmatrix} 0 \\ z \end{bmatrix} = \frac{z}{z(z-1)}$$

(c) $A = \begin{bmatrix} 0 & 1 & 0 \\ 0 & 0 & 1 \end{bmatrix}; B = \begin{bmatrix} 0 \\ 2 \end{bmatrix}; C = \begin{bmatrix} 1 & 0 \end{bmatrix}; D = 0;$
 $[\text{num}, \text{den}] = \text{ss2tf}(A, B, C, D)$

2-24. (a)

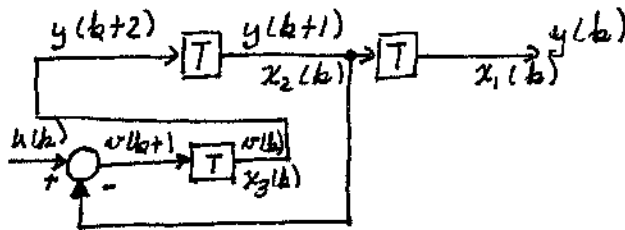

$$\underline{x}(k+1) = \begin{bmatrix} 0 & 1 & 0 \\ 0 & 0 & 1 \\ 0 & -1 & 0 \end{bmatrix} \underline{x}(k) + \begin{bmatrix} 0 \\ 0 \\ 1 \end{bmatrix} u(k)$$

$$\underline{y}_o(k) = \begin{bmatrix} x_2(k) \\ x_3(k) \end{bmatrix} = \begin{bmatrix} 0 & 1 & 0 \\ 0 & 0 & 1 \end{bmatrix} \underline{x}(k); \quad \underline{y}_o(k) = \text{output}$$

(b) $\underline{x}(k+1) = \text{same as (a)}$

$$\underline{y}_o(k) = \begin{bmatrix} x_1(k) \\ x_3(k) \end{bmatrix} = \begin{bmatrix} 1 & 0 & 0 \\ 0 & 0 & 1 \end{bmatrix} \underline{x}(k)$$

(c) $\underline{x}(k+1) = \text{same as (a)}$

$$\underline{y}_o(k) = x_3(k) = \begin{bmatrix} 0 & 0 & 1 \end{bmatrix} \underline{x}(k)$$

(d) $zI-A = \begin{bmatrix} z & -1 & 0 \\ 0 & z & -1 \\ 0 & 1 & z \end{bmatrix}; \quad |zI-A| = z^3 - (-z) = z^3 + z = \Delta$

2-24(d)

$$\text{cof}(zI-A) = \begin{bmatrix} z^2+1 & z^2 & 0 \\ z & z^2 & z \\ 1 & z & z^2 \end{bmatrix}; (zI-A)^{-1} = \frac{1}{\Delta} \begin{bmatrix} z^2+1 & z & 1 \\ z^2 & z^2 & z \\ 0 & z & z^2 \end{bmatrix}$$

$$\begin{aligned} \therefore \frac{Y_0(z)}{U(z)} &= C(zI-A)^{-1}B = \frac{1}{\Delta} [0 \ 0 \ 1] \begin{bmatrix} 0 \\ 0 \\ 1 \end{bmatrix} \\ &= \frac{1}{\Delta} [0 \ z \ z^2] \begin{bmatrix} 0 \\ 0 \\ 1 \end{bmatrix} = \frac{z^2}{z^3-z} = \frac{z}{z^2+1} \end{aligned}$$

$$(e) \quad z^2 Y(z) - V(z) = 0 \Rightarrow Y(z) = \frac{1}{z^2} V(z)$$

$$z Y(z) + z Y(z) = z V(z) + \frac{1}{z} V(z) = U(z)$$

$$\therefore \frac{Y(z)}{U(z)} = \frac{Y_0(z)}{U(z)} = \frac{1}{z + \frac{1}{z}} = \frac{z}{z^2+1}$$

(f) From (a):

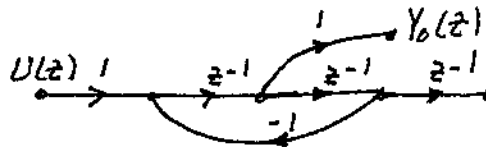

$$\therefore \frac{Y_0(z)}{U(z)} = \frac{z^{-1}}{1+z^{-2}} = \frac{z}{z^2+1}$$

(g)

$$A = [0 \ 1 \ 0; 0 \ 0 \ 1; 0 \ -1 \ 0]; B = [0; 0; 1]; C = [0 \ 0 \ 1]; D = 0;$$

$$[\text{num}, \text{den}] = \text{ss2tf}(A, B, C, D)$$

2-25.

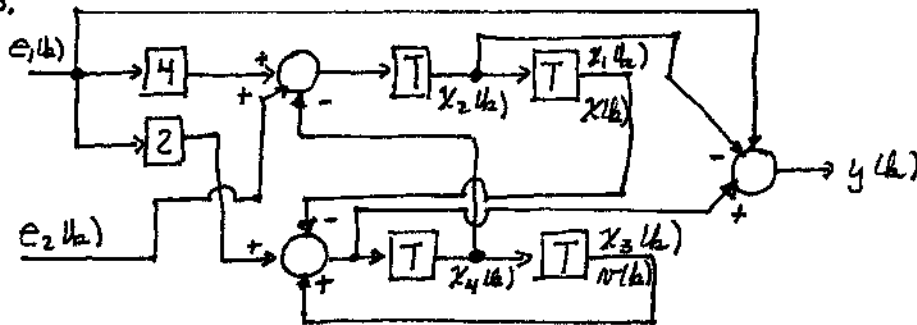

$$x(k+1) = \begin{bmatrix} 0 & 1 & 0 & 0 \\ 0 & 0 & 0 & -1 \\ 0 & 0 & 0 & 1 \\ -1 & 0 & 1 & 0 \end{bmatrix} x(k) + \begin{bmatrix} 0 & 0 \\ 4 & 1 \\ 0 & 0 \\ 2 & 0 \end{bmatrix} e(k)$$

$$2-25. \quad y(k) = x_4(k+1) - x_2(k) + e_1(k) = -x_1(k) + x_3(k) - x_2(k) + e_1(k)$$

$$\therefore y(k) = [-1 \quad -1 \quad 1 \quad 0] \underline{x}(k) + [1 \quad 0] \underline{e}(k)$$

$$2-26(a) \quad zI - A = \begin{bmatrix} z & -1 \\ 0 & z-3 \end{bmatrix}; \quad \Delta = |zI - A| = z(z-3) = \Delta$$

$$\frac{Y(z)}{U(z)} = C(zI - A)^{-1}B = \frac{1}{\Delta} [-2 \quad 1] \begin{bmatrix} z-3 & 1 \\ 0 & z \end{bmatrix} \begin{bmatrix} 1 \\ 1 \end{bmatrix}$$

$$= \frac{1}{\Delta} [-2z + 6 \quad z-2] \begin{bmatrix} 1 \\ 1 \end{bmatrix} = \frac{-z+4}{z(z-3)}$$

$$(b) \quad P = \begin{bmatrix} 1 & -1 \\ 1 & 1 \end{bmatrix}; \quad P^{-1} = \begin{bmatrix} 1/2 & 1/2 \\ -1/2 & 1/2 \end{bmatrix}$$

$$A_w = P^{-1}AP = \begin{bmatrix} 1/2 & 1/2 \\ -1/2 & 1/2 \end{bmatrix} \begin{bmatrix} 0 & 1 \\ 0 & 3 \end{bmatrix} \begin{bmatrix} 1 & -1 \\ 1 & 1 \end{bmatrix} = \begin{bmatrix} 1/2 & 1/2 \\ -1/2 & 1/2 \end{bmatrix} \begin{bmatrix} 1 & 1 \\ 3 & 3 \end{bmatrix}$$

$$= \begin{bmatrix} 2 & 2 \\ 1 & 1 \end{bmatrix}$$

$$B_w = P^{-1}B = \begin{bmatrix} 1/2 & 1/2 \\ -1/2 & 1/2 \end{bmatrix} \begin{bmatrix} 1 \\ 1 \end{bmatrix} = \begin{bmatrix} 1 \\ 0 \end{bmatrix}$$

$$C_w = CP = [-2 \quad 1] \begin{bmatrix} 1 & -1 \\ 1 & 1 \end{bmatrix} = [-1 \quad 3]$$

$$\therefore \underline{w}(k+1) = \begin{bmatrix} 2 & 2 \\ 1 & 1 \end{bmatrix} \underline{w}(k) + \begin{bmatrix} 1 \\ 0 \end{bmatrix} u(k)$$

$$y(k) = [-1 \quad 3] \underline{w}(k)$$

$$(c) \quad zI - A_w = \begin{bmatrix} z-2 & -2 \\ -1 & z-1 \end{bmatrix}; \quad \Delta = |zI - A_w| = z^2 - 3z + 2 - 2 = z(z-3)$$

$$\frac{Y(z)}{U(z)} = C_w(zI - A_w)^{-1}B_w = \frac{1}{\Delta} [-1 \quad 3] \begin{bmatrix} z-1 & 2 \\ 1 & z-2 \end{bmatrix} \begin{bmatrix} 1 \\ 0 \end{bmatrix}$$

$$= \frac{1}{\Delta} [-1 \quad 3] \begin{bmatrix} z-1 \\ 1 \end{bmatrix} = \frac{-z+4}{z(z-3)}$$

$$(d) \quad |zI - A| = \begin{vmatrix} z & 1 \\ 0 & z-3 \end{vmatrix} = z^2 - 3z; \quad |zI - A_w| = \begin{vmatrix} z-2 & -2 \\ -1 & z-1 \end{vmatrix} = z(z-3)$$

$$\therefore z_1 = 0, z_2 = 3$$

$$|A| = \begin{vmatrix} 0 & 1 \\ 0 & 3 \end{vmatrix} = 0 = z_1 z_2; \quad |A_w| = \begin{vmatrix} 2 & 2 \\ 1 & 1 \end{vmatrix} = 0$$

$$\text{tr } A = \underline{3} = z_1 + z_2; \quad \text{tr } A_w = \underline{3}$$

2-26 (e)

$$A = \begin{bmatrix} 0 & 1 \\ 0 & 3 \end{bmatrix}; B = \begin{bmatrix} 1 \\ 1 \end{bmatrix}; C = \begin{bmatrix} -2 & 1 \end{bmatrix}; D = 0;$$

$$[\text{num}, \text{den}] = \text{ss2tf}(A, B, C, D)$$

pause

$$A = \begin{bmatrix} 2 & 2 \\ 1 & 1 \end{bmatrix}; B = \begin{bmatrix} 1 \\ 0 \end{bmatrix}; C = \begin{bmatrix} -1 & 3 \end{bmatrix}; D = 0;$$

$$[\text{num}, \text{den}] = \text{ss2tf}(A, B, C, D)$$

2-27. (a) Let z_1, z_2 be the characteristic value of A .

$$zI - A = \begin{bmatrix} z & -1 \\ 0 & z-3 \end{bmatrix}, \therefore |zI - A| = z(z-3); \therefore \underline{z_1 = 0}, \underline{z_2 = 3}$$

$$(b) (z_1 I - A) \underline{m}_1 = \begin{bmatrix} 0 & -1 \\ 0 & -3 \end{bmatrix} \begin{bmatrix} m_{11} \\ m_{21} \end{bmatrix} = \begin{bmatrix} 0 \\ 0 \end{bmatrix} \Rightarrow \begin{matrix} -m_{21} = 0 \\ -3m_{21} = 0 \end{matrix}$$

$$\therefore m_{21} = 0, \text{ let } m_{11} = 1, \therefore \underline{m}_1 = \begin{bmatrix} 1 \\ 0 \end{bmatrix}$$

$$(z_2 I - A) \underline{m}_2 = \begin{bmatrix} 3 & -1 \\ 0 & 0 \end{bmatrix} \begin{bmatrix} m_{12} \\ m_{22} \end{bmatrix} = \begin{bmatrix} 0 \\ 0 \end{bmatrix} \Rightarrow 3m_{12} - m_{22} = 0$$

$$\therefore \text{let } m_{12} = 1, m_{22} = 3, \therefore \underline{m}_2 = \begin{bmatrix} 1 \\ 3 \end{bmatrix}$$

$$\therefore M = \begin{bmatrix} 1 & 1 \\ 0 & 3 \end{bmatrix}, |M| = 3, M^{-1} = \begin{bmatrix} 1 & -1/3 \\ 0 & 1/3 \end{bmatrix}$$

$$M^{-1} A M = \begin{bmatrix} 1 & -1/3 \\ 0 & 1/3 \end{bmatrix} \begin{bmatrix} 0 & 1 \\ 0 & 3 \end{bmatrix} \begin{bmatrix} 1 & 1 \\ 0 & 3 \end{bmatrix} = \begin{bmatrix} 1 & -1/3 \\ 0 & 1/3 \end{bmatrix} \begin{bmatrix} 0 & 3 \\ 0 & 9 \end{bmatrix} = \begin{bmatrix} 0 & 0 \\ 0 & 3 \end{bmatrix}$$

$$(c) B_w = M^{-1} B = \begin{bmatrix} 1 & -1/3 \\ 0 & 1/3 \end{bmatrix} \begin{bmatrix} 1 \\ 1 \end{bmatrix} = \begin{bmatrix} 2/3 \\ 1/3 \end{bmatrix}$$

$$C_w = C M = \begin{bmatrix} -2 & 1 \end{bmatrix} \begin{bmatrix} 1 & 1 \\ 0 & 3 \end{bmatrix} = \begin{bmatrix} -2 & 1 \end{bmatrix}$$

$$\therefore \underline{w}(k+1) = \begin{bmatrix} 0 & 0 \\ 0 & 3 \end{bmatrix} \underline{w}(k) + \begin{bmatrix} 2/3 \\ 1/3 \end{bmatrix} u(k)$$

$$y(k) = \begin{bmatrix} -2 & 1 \end{bmatrix} \underline{w}(k)$$

(d) See Problem 2-26 (c) for the first transfer function.

$$zI - A_w = \begin{bmatrix} z & 0 \\ 0 & z-3 \end{bmatrix}; |zI - A_w| = z(z-3) = \Delta$$

$$\frac{Y(z)}{U(z)} = C_w (zI - A_w)^{-1} B_w = \frac{1}{\Delta} \begin{bmatrix} -2 & 1 \end{bmatrix} \begin{bmatrix} z-3 & 0 \\ 0 & z \end{bmatrix} \begin{bmatrix} 2/3 \\ 1/3 \end{bmatrix}$$

$$= \frac{1}{\Delta} \begin{bmatrix} -2z+6 & z \end{bmatrix} \begin{bmatrix} 2/3 \\ 1/3 \end{bmatrix} = \frac{-\frac{4}{3}z+4+\frac{1}{3}z}{\Delta} = \frac{-z+4}{z(z-3)}$$

2-27. (e) $A = \begin{bmatrix} 0 & 1 \\ 0 & 3 \end{bmatrix}; B = \begin{bmatrix} 1 \\ 1 \end{bmatrix}; C = \begin{bmatrix} -2 & 1 \end{bmatrix}; D = 0;$
 $[\text{num}, \text{den}] = \text{ss2tf}(A, B, C, D)$

$A = \begin{bmatrix} 0 & 0 \\ 0 & -3 \end{bmatrix}; B = \begin{bmatrix} .6667 \\ .3333 \end{bmatrix}; C = \begin{bmatrix} -2 & 1 \end{bmatrix}; D = 0;$
 $[\text{num}, \text{den}] = \text{ss2tf}(A, B, C, D)$

2-28. (a) $\frac{Y(z)}{U(z)} = \frac{-z+4}{z(z-3)}$; from Problem 2-26(c)

(b) $Y(z) = \frac{(-z+4)z}{z(z-3)(z-1)}$

$\frac{Y(z)}{z} = \frac{-z+4}{z(z-1)(z-3)} = \frac{4/3}{z} + \frac{-3/2}{z-1} + \frac{1/6}{z-3}$

$\therefore y(k) = \begin{cases} 4/3 - 3/2 + 1/6 = 0, & k=0 \\ -3/2 + 1/6(3)^k, & k \geq 1 \end{cases}$ $\therefore y(0) = 0$ $y(2) = -3/2 + 1/6 = 0$
 $y(1) = -3/2 + 1/6 = -1$

(c) From Problem 2.26(c),

$\Phi(z) = z(zI - A)^{-1} = z \begin{bmatrix} \frac{z-3}{z(z-3)} & \frac{1}{z(z-3)} \\ 0 & \frac{z}{z(z-3)} \end{bmatrix} = z \begin{bmatrix} \frac{1}{z} & \frac{-1/3 + 1/3}{z(z-3)} \\ 0 & \frac{1}{z-3} \end{bmatrix}$

$\therefore \Phi(k) = \begin{bmatrix} \delta(k) & -\frac{1}{3}\delta(k) + \frac{1}{3}(3)^k \\ 0 & (3)^k \end{bmatrix}$

(d) $y(k) = \sum_{j=0}^{k-1} C \Phi(k-1-j) B u_j = \sum_{j=0}^{k-1} \begin{bmatrix} -2 & 1 \end{bmatrix} \Phi(k-1-j) \begin{bmatrix} 1 \\ 1 \end{bmatrix}$

$= \sum_{j=0}^{k-1} \begin{bmatrix} -2 & 1 \end{bmatrix} \begin{bmatrix} \frac{2}{3}\delta(k-1-j) + \frac{1}{3}(3)^{k-j-1} \\ (3)^{k-j-1} \end{bmatrix} = \sum_{j=0}^{k-1} \begin{bmatrix} -\frac{4}{3}\delta(k-1-j) + \frac{1}{3}(3)^{k-j-1} \end{bmatrix}$

$= \sum_{j=0}^{k-1} \begin{bmatrix} -\frac{4}{3}\delta(k-1-j) + \frac{1}{3}(3)^{k-1-j} \end{bmatrix}$

$y(0) = 0$; $y(1) = -\frac{4}{3}\delta(0) + \frac{1}{3}(3)^0 = -\frac{4}{3} + \frac{1}{3} = -1$

$y(2) = -\frac{4}{3}\delta(1) + \frac{1}{3}(3)^1 - \frac{4}{3}\delta(0) + \frac{1}{3}(3)^0 = 1 - \frac{4}{3} + \frac{1}{3} = 0$

(e) $x(1) = \begin{bmatrix} 0 & 1 \\ 0 & 3 \end{bmatrix} \begin{bmatrix} 0 \\ 0 \end{bmatrix} + \begin{bmatrix} 1 \\ 1 \end{bmatrix} = \begin{bmatrix} 1 \\ 1 \end{bmatrix}$; $y(1) = \begin{bmatrix} -2 & 1 \end{bmatrix} \begin{bmatrix} 1 \\ 1 \end{bmatrix} = -1$

$x(2) = \begin{bmatrix} 0 & 1 \\ 0 & 3 \end{bmatrix} \begin{bmatrix} 1 \\ 1 \end{bmatrix} + \begin{bmatrix} 1 \\ 1 \end{bmatrix} = \begin{bmatrix} 2 \\ 4 \end{bmatrix}$; $y(2) = \begin{bmatrix} -2 & 1 \end{bmatrix} \begin{bmatrix} 2 \\ 4 \end{bmatrix} = 0$

2-29. (a) From Problem 2-30(a),

$$2-30.(a) \frac{Y(z)}{U(z)} = C(zI-A)^{-1}B = [1 \quad z] \begin{bmatrix} \frac{1}{z-1} & 0 \\ 0 & \frac{1}{z-0.5} \end{bmatrix} \begin{bmatrix} 2 \\ 1 \end{bmatrix}$$

$$= [1 \quad z] \begin{bmatrix} \frac{2}{z-1} \\ \frac{1}{z-0.5} \end{bmatrix} = \frac{2}{z-1} + \frac{z}{z-0.5} = \frac{4z-3}{(z-1)(z-0.5)}$$

$$(b) P = \begin{bmatrix} 1 & -1 \\ 1 & 1 \end{bmatrix}, P^{-1} = \begin{bmatrix} \frac{1}{2} & \frac{1}{2} \\ -\frac{1}{2} & \frac{1}{2} \end{bmatrix}$$

$$\therefore A_w = P^{-1}AP = \begin{bmatrix} \frac{1}{2} & \frac{1}{2} \\ -\frac{1}{2} & \frac{1}{2} \end{bmatrix} \begin{bmatrix} 1 & 0 \\ 0 & \frac{1}{2} \end{bmatrix} \begin{bmatrix} 1 & -1 \\ 1 & 1 \end{bmatrix} = \begin{bmatrix} \frac{1}{2} & \frac{1}{4} \\ -\frac{1}{2} & \frac{1}{4} \end{bmatrix} \begin{bmatrix} 1 & -1 \\ 1 & 1 \end{bmatrix} = \begin{bmatrix} \frac{3}{4} & -\frac{1}{4} \\ -\frac{1}{4} & \frac{3}{4} \end{bmatrix}$$

$$B_w = P^{-1}B = \begin{bmatrix} \frac{1}{2} & \frac{1}{2} \\ -\frac{1}{2} & \frac{1}{2} \end{bmatrix} \begin{bmatrix} 2 \\ 1 \end{bmatrix} = \begin{bmatrix} \frac{3}{2} \\ -\frac{1}{2} \end{bmatrix}$$

$$C_w = CP = [1 \quad z] \begin{bmatrix} 1 & -1 \\ 1 & 1 \end{bmatrix} = [3 \quad 1]$$

$$\therefore \underline{w}(k+1) = \begin{bmatrix} \frac{3}{4} & -\frac{1}{4} \\ -\frac{1}{4} & \frac{3}{4} \end{bmatrix} \underline{w}(k) + \begin{bmatrix} \frac{3}{2} \\ -\frac{1}{2} \end{bmatrix} u(k)$$

$$y(k) = [3 \quad 1] \underline{x}(k)$$

$$(c) zI - A_w = \begin{bmatrix} z - \frac{3}{4} & \frac{1}{4} \\ \frac{1}{4} & z - \frac{3}{4} \end{bmatrix}, |zI - A_w| = z^2 - 1.5z + \frac{9}{16} - \frac{1}{16} = z^2 - 1.5z + 0.5 = \Delta$$

$$\frac{Y(z)}{U(z)} = C_w(zI - A_w)^{-1}B_w = [3 \quad 1] \frac{1}{\Delta} \begin{bmatrix} z - \frac{3}{4} & -\frac{1}{4} \\ -\frac{1}{4} & z - \frac{3}{4} \end{bmatrix} \begin{bmatrix} \frac{3}{2} \\ -\frac{1}{2} \end{bmatrix}$$

$$= \frac{1}{\Delta} [3z - 2.5 \quad z - 1.5] \begin{bmatrix} \frac{3}{2} \\ -\frac{1}{2} \end{bmatrix} = \frac{4z-3}{(z-1)(z-0.5)}$$

$$(d) |zI - A| = \begin{vmatrix} z-1 & 0 \\ 0 & z-0.5 \end{vmatrix} = \underline{z^2 - 1.5z + 0.5}; |zI - A_w| = \underline{z^2 - 1.5z + 0.5}$$

$$\therefore z_1 = 1, z_2 = 0.5$$

$$|A| = \begin{vmatrix} 1 & 0 \\ 0 & 0.5 \end{vmatrix} = \underline{0.5} = z_1 z_2; |A_w| = \begin{vmatrix} \frac{3}{4} & -\frac{1}{4} \\ -\frac{1}{4} & \frac{3}{4} \end{vmatrix} = \frac{9}{16} - \frac{1}{16} = \underline{0.5}$$

$$\text{tr } A = \underline{1.5} = z_1 + z_2; \text{tr } A_w = \underline{1.5}$$

$$2-30.(a) zI - A = \begin{bmatrix} z-1 & 0 \\ 0 & z-0.5 \end{bmatrix}; |zI - A| = \Delta = (z-1)(z-0.5)$$

$$(zI - A^{-1}) = \frac{1}{\Delta} \begin{bmatrix} z-0.5 & 0 \\ 0 & z-1 \end{bmatrix} = \begin{bmatrix} \frac{1}{z-1} & 0 \\ 0 & \frac{1}{z-0.5} \end{bmatrix}$$

$$2-30 (a) \therefore \Phi(k) = z^{-1} \begin{bmatrix} z & 0 \\ 0 & z-0.5 \end{bmatrix} = \begin{bmatrix} 1 & 0 \\ 0 & 0.5^k \end{bmatrix}$$

$$\therefore \underline{x}(k) = \Phi(k) \underline{x}(0) = \begin{bmatrix} 1 & 0 \\ 0 & 0.5^k \end{bmatrix} \begin{bmatrix} 1 \\ 2 \end{bmatrix} = \begin{bmatrix} 1 \\ 2(0.5)^k \end{bmatrix}$$

$$(b) y(k) = C \underline{x}(k) = [1 \quad 2] \begin{bmatrix} 1 \\ 2(0.5)^k \end{bmatrix} = \underline{1 + 4(0.5)^k}$$

$$(c) \Phi(0) = \begin{bmatrix} 1 & 0 \\ 0 & 0.5^0 \end{bmatrix} = \begin{bmatrix} 1 & 0 \\ 0 & 1 \end{bmatrix} = I$$

$$(d) \underline{x}(k) \Big|_{k=0} = \begin{bmatrix} 1 \\ 2(0.5)^k \end{bmatrix} = \begin{bmatrix} 1 \\ 2 \end{bmatrix}$$

$$(e) \text{ From (b), } \begin{array}{ll} y(0) = \underline{5} & y(2) = \underline{2} \\ y(1) = \underline{3} & y(3) = \underline{1.5} \end{array}$$

$$y(0) = C \underline{x}(0) = [1 \quad 2] \begin{bmatrix} 1 \\ 2 \end{bmatrix} = \underline{5}$$

$$\underline{x}(1) = \begin{bmatrix} 1 & 0 \\ 0 & 0.5 \end{bmatrix} \begin{bmatrix} 1 \\ 2 \end{bmatrix} = \begin{bmatrix} 1 \\ 1 \end{bmatrix}, \quad y(1) = [1 \quad 2] \begin{bmatrix} 1 \\ 1 \end{bmatrix} = \underline{3}$$

$$\underline{x}(2) = \begin{bmatrix} 1 & 0 \\ 0 & 0.5 \end{bmatrix} \begin{bmatrix} 1 \\ 1 \end{bmatrix} = \begin{bmatrix} 1 \\ 0.5 \end{bmatrix}, \quad y(2) = [1 \quad 2] \begin{bmatrix} 1 \\ 0.5 \end{bmatrix} = \underline{2}$$

$$\underline{x}(3) = \begin{bmatrix} 1 & 0 \\ 0 & 0.5 \end{bmatrix} \begin{bmatrix} 1 \\ 0.5 \end{bmatrix} = \begin{bmatrix} 1 \\ 0.25 \end{bmatrix}, \quad y(3) = [1 \quad 2] \begin{bmatrix} 1 \\ 0.25 \end{bmatrix} = \underline{1.5}$$

(f) `A = [1 0; 0 .5]; B = [2; 1]; C = [1 2];
x=[1; 2];
u = 0;
for k = 0:3
x1 = A*x + B*u;
y = C*x;
[k, Y]
x = x1;
end`

$$2-31.(a) zI - A = \begin{bmatrix} z-1.1 & -1 \\ 0.3 & z \end{bmatrix}; \quad |zI - A| = \Delta = z^2 - 1.1z + 0.3 = (z-0.5)(z-0.6)$$

$$(zI - A)^{-1} = \frac{1}{\Delta} \begin{bmatrix} z & 1 \\ -0.3 & z-1.1 \end{bmatrix}$$

$$2-31(a) \quad \Phi(k) = z^{-1} [z(zI-A)^{-1}] = z^{-1} \left(z \begin{bmatrix} \frac{z}{(z-0.5)(z-0.6)} & \frac{1}{(z-0.5)(z-0.6)} \\ \frac{-0.3}{(z-0.5)(z-0.6)} & \frac{z-1.1}{(z-0.5)(z-0.6)} \end{bmatrix} \right)$$

$$= z^{-1} \left(z \begin{bmatrix} \frac{-5}{z-0.5} + \frac{6}{z-0.6} & \frac{-10}{z-0.5} + \frac{10}{z-0.6} \\ \frac{3}{z-0.5} + \frac{-3}{z-0.6} & \frac{6}{z-0.5} + \frac{-5}{z-0.6} \end{bmatrix} \right)$$

$$= \begin{bmatrix} -5(0.5)^k + 6(0.6)^k & -10(0.5)^k + 10(0.6)^k \\ 3(0.5)^k - 3(0.6)^k & 6(0.5)^k - 5(0.6)^k \end{bmatrix}$$

$$\therefore \underline{x}(k) = \Phi(k) \underline{x}(0) = \begin{bmatrix} 1 & 0 \\ 0 & 1 \end{bmatrix} \begin{bmatrix} -1 \\ 2 \end{bmatrix} = \begin{bmatrix} -15(0.5)^k + 14(0.6)^k \\ 9(0.5)^k - 7(0.6)^k \end{bmatrix}$$

$$(b) \quad y(k) = C \underline{x}(k) = [1 \quad -1] \underline{x}(k) = -24(0.5)^k + 21(0.6)^k$$

$$(c) \quad \Phi(0) = \begin{bmatrix} -5+6 & -10+10 \\ 3-3 & 6-5 \end{bmatrix} = \begin{bmatrix} 1 & 0 \\ 0 & 1 \end{bmatrix} = I$$

$$(d) \quad \underline{x}(k) \Big|_{k=0} = \begin{bmatrix} -15+14 \\ 9-7 \end{bmatrix} = \begin{bmatrix} -1 \\ 2 \end{bmatrix}$$

$$(e) \text{ From (b), } \begin{array}{ll} y(0) = -3 & y(2) = 1.56 \\ y(1) = 0.6 & y(3) = 1.536 \end{array}$$

$$y(0) = C \underline{x}(0) = [1 \quad -1] \begin{bmatrix} -1 \\ 2 \end{bmatrix} = -3$$

$$\underline{x}(1) = \begin{bmatrix} 1.1 & 1 \\ -0.3 & 0 \end{bmatrix} \begin{bmatrix} -1 \\ 2 \end{bmatrix} = \begin{bmatrix} 0.9 \\ 0.3 \end{bmatrix}; \quad y(1) = [1 \quad -1] \begin{bmatrix} 0.9 \\ 0.3 \end{bmatrix} = 0.6$$

$$\underline{x}(2) = \begin{bmatrix} 1.1 & 1 \\ -0.3 & 0 \end{bmatrix} \begin{bmatrix} 0.9 \\ 0.3 \end{bmatrix} = \begin{bmatrix} 1.29 \\ -0.27 \end{bmatrix}; \quad y(2) = [1 \quad -1] \begin{bmatrix} 1.29 \\ -0.27 \end{bmatrix} = 1.56$$

$$\underline{x}(3) = \begin{bmatrix} 1.1 & 1 \\ -0.3 & 0 \end{bmatrix} \begin{bmatrix} 1.29 \\ -0.27 \end{bmatrix} = \begin{bmatrix} 1.149 \\ -0.387 \end{bmatrix}; \quad y(3) = [1 \quad -1] \begin{bmatrix} 1.149 \\ -0.387 \end{bmatrix} = 1.536$$

(f)

$$A = [1.1 \quad 1; -0.3 \quad 0]; \quad B = [1; 1]; \quad C = [1 \quad -1];$$

$$\underline{x} = [-1; 2];$$

$$u = 0;$$

for k = 0:3

$$\underline{x}_1 = A * \underline{x} + B * u;$$

$$y = C * \underline{x};$$

$$[k, y]$$

$$\underline{x} = \underline{x}_1;$$

end

$$2-32. \quad \underline{x}(k+1) = \begin{bmatrix} - & n-1 & 1 & 0 & \dots & 0 \\ - & n-2 & 0 & 1 & \dots & 0 \\ \vdots & \vdots & \vdots & \vdots & \ddots & \vdots \\ - & 0 & 0 & 0 & \dots & 0 \end{bmatrix} \underline{x}(k) + \begin{bmatrix} a_{n-1} \\ b_{n-2} \\ \vdots \\ b_0 \end{bmatrix} u(k)$$

$$y(k) = [1 \ 0 \ 0 \ \dots \ 0] \underline{x}(k)$$

$$2-33. \quad \underline{x}(k+1) = A \underline{x}(k) ; \quad \underline{x}(k) = \Phi(k) \underline{x}(0)$$

$$\therefore \Phi(k+1) \underline{x}(0) = A \Phi(k) \underline{x}(0)$$

Since this is true for any $\underline{x}(0)$, $\therefore \underline{\Phi}(k+1) = A \underline{\Phi}(k)$

$$2-34 (a) \quad zI - A = \begin{bmatrix} z-1 & 0 & 0 \\ -1 & z-1 & 0 \\ 0 & -1 & z \end{bmatrix}; \quad \Delta = z^3 - 2z^2 + z = z(z-1)^2$$

$$\text{cof}(zI - A) = \begin{bmatrix} z(z-1) & z & 1 \\ 0 & z(z-1) & z-1 \\ 0 & 0 & (z-1)^2 \end{bmatrix}, \quad (zI - A)^{-1} = \begin{bmatrix} \frac{1}{z-1} & 0 & 0 \\ \frac{1}{(z-1)^2} & \frac{1}{z-1} & 0 \\ \frac{1}{z(z-1)^2} & \frac{1}{z(z-1)} & \frac{1}{z} \end{bmatrix}$$

$$G(z) = C(zI - A)^{-1}B = [0 \ 0 \ 1] (zI - A)^{-1} \begin{bmatrix} 1 \\ 0 \\ 0 \end{bmatrix}$$

$$= \left[\frac{1}{z(z-1)^2} \quad \frac{1}{z(z-1)} \quad \frac{1}{z} \right] \begin{bmatrix} 1 \\ 0 \\ 0 \end{bmatrix} = \frac{1}{z(z-1)^2} = \frac{1}{z^3 - 2z^2 + z}$$

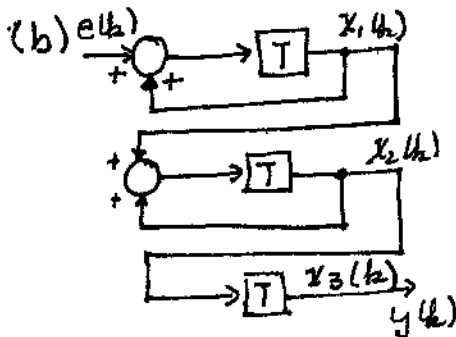

$$(c) \quad \Delta = 1 - z^{-1} - z^{-1} + z^{-2} = 1 - 2z^{-1} + z^{-2}$$

$$\therefore G(z) = \frac{z^{-3}}{\Delta} = \frac{1}{z^3 - 2z^2 + z}$$

2-34. (d)

$$A = \begin{bmatrix} 1 & 0 & 0 \\ 1 & 1 & 0 \\ 0 & 1 & 0 \end{bmatrix}; B = \begin{bmatrix} 1 \\ 0 \\ 0 \end{bmatrix}; C = \begin{bmatrix} 0 & 0 & 1 \end{bmatrix}; D = 0;$$

$$[\text{num}, \text{den}] = \text{ss2tf}(A, B, C, D)$$

$$2-35. C_w (zI - A_w)^{-1} B_w + D_w = CP [zI - P^{-1}AP]^{-1} P^{-1}B + D$$

$$= CP [zP^{-1}IP - P^{-1}AP]^{-1} P^{-1}B + D$$

$$= CP [P^{-1}(zI - A)P]^{-1} P^{-1}B + D$$

$$= CPP^{-1} (zI - A)^{-1} PP^{-1}B + D \quad ; \text{ since } (ABC)^{-1} = C^{-1}B^{-1}A^{-1}$$

$$= C(zI - A)^{-1}B + D$$

2-36. (a)

$$n = \begin{bmatrix} 0 & 3 & 4 \end{bmatrix};$$

$$d = \begin{bmatrix} 1 & 5 & 6 \end{bmatrix};$$

$$[A, B, C, D] = \text{tf2ss}(n, d)$$

$$\underline{x}(k+1) = \begin{bmatrix} -5 & -6 \\ 1 & 0 \end{bmatrix} \underline{x}(k) + \begin{bmatrix} 1 \\ 0 \end{bmatrix} u(k)$$

$$y(k) = \begin{bmatrix} 3 & 4 \end{bmatrix} \underline{x}(k)$$

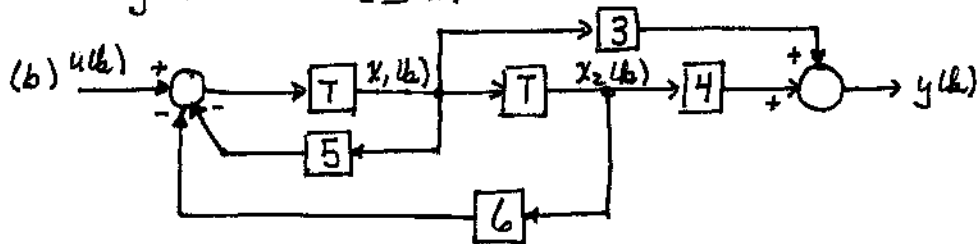

(c) The control canonical form with the states renumbered.