

CHAPTER 2: MODELING OF SDOF SYSTEMS

Short Answer Problems

2.1 True: the differential equations are the same because the resultant of gravity and the static spring force is zero for the case of the hanging mass-spring-viscous damper system.

2.2 False: The differential equation governing the motion of a SDOF linear system is second order.

2.3 False: Springs in parallel have an equivalent stiffness that is the sum of the individual stiffnesses of these springs.

2.4 False: The equivalent stiffness of a uniform simply supported beam at its middle is $\frac{48EI}{L^3}$.

2.5 True: Viscous damping is often added to a system to add a linear term in the governing differential equation.

2.6 False: When the equivalent systems method is used to derive the differential equation for a system with an angular coordinate used as the generalized coordinate the kinetic energy is used to derive the equivalent moment of inertia of the system.

2.7 True: The equivalent systems method applied only to linear systems.

2.8 False: The inertia effects of simply supported beam can be approximated by calculating the kinetic energy of the beam in terms of the velocity of the generalized coordinate and placing a particle of appropriate mass at the location whose displacement the generalized coordinate represents.

2.9 False: The static deflection of the spring in the system of Fig. SP2.9 is $\frac{mg}{2k}$.

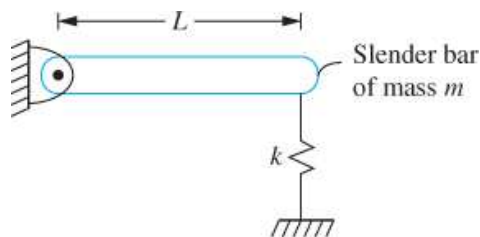

FIGURE SP 2.09

2.10 False: The springs in the system of Fig. SP2.10 are in parallel (the springs have the same displacement, x , and the resultant force on the FBD of the block is the sum of the spring forces).

2.11 True: A shaft is an elastic member in which an angular displacement occurs when acted on by a torque. The angular displacement has a value of $\theta = TL/(JG)$.

2.12 True: The equivalent viscous damping coefficient is calculated by comparing the energy dissipation in the combination of viscous dampers to that of an equivalent viscous damper.

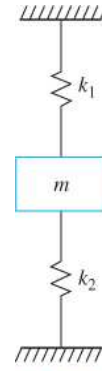

FIGURE SP 2.10

2.13 False: The added mass of a fluid entrained by a vibrating system is determined by calculating the kinetic energy developed in the fluid.

2.14 False: If it is desired to calculate the reactions at the support of Fig SP2.14 the effects of the static spring force and gravity cancel and do need to be included on the FBD or in summing forces on the FBD (the cancelling of static spring forces with gravity only applies to the derivation of the differential equation).

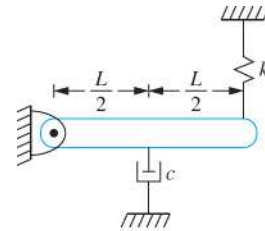

FIGURE SP 2.14

2.15 False: Gravity does not cancel with the static spring force in the system of Figure SP2.15 and hence the potential energy of both is included in potential energy calculations. (Assuming small θ the potential energy in the spring is $\frac{1}{2}k\left(\frac{2L}{3}\theta\right)^2$. The potential energy due to gravity assuming the datum is the pin support is $mg\frac{L}{6}\sin\theta$).

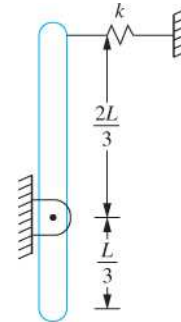

FIGURE SP 2.15

2.16 The small angle assumption is used to linearize nonlinear systems a priori. If the angular displacement is small it is assumed that $\sin\theta \approx \theta$, $\cos\theta \approx 1$, $\tan\theta \approx \theta$ in derivation of the differential equation.

2.17 FBD's are drawn at an arbitrary instant for derivation of differential equations.

2.18 A quadratic form is form of kinetic energy equal to $\frac{1}{2}m\dot{x}^2$ when used to apply the equivalent systems method to derive a differential equation. The potential energy has a quadratic form of $\frac{1}{2}kx^2$.

2.19 The inertia effects of the spring in a mass-spring-viscous damper system can be approximated by adding a particle of 1/3 the mass of the spring to the point on the system where the spring is attached.

2.20 Each spring in a parallel combination has the same displacement.

2.21 The equivalent stiffness of a combination of springs is calculated by requiring the total potential energy of the combination when written in terms of the displacement of the

particle where the equivalent spring is to be attached is equal to the potential energy of a spring of equivalent stiffness placed at that location.

2.22 The FBD is shown at an arbitrary instant.

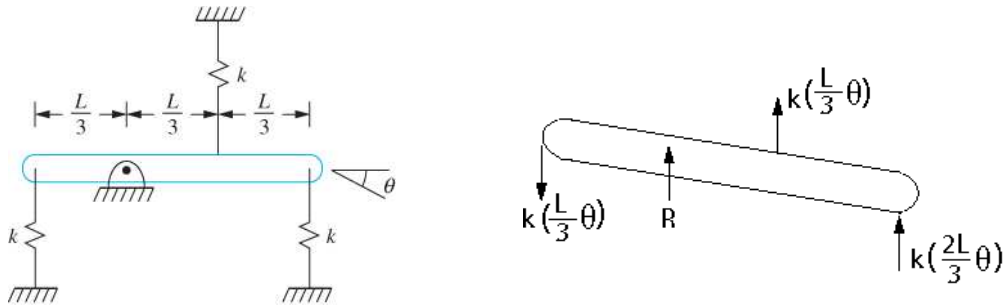

FIGURE SP 2.22

2.23 At an arbitrary instant the upper bar has rotated through an angle θ , measured positive clockwise. The lower bar has an angular displacement ϕ , measure counterclockwise. The displacements of the particles must be the same where the rigid bar is attached, $\frac{L}{2}\theta = \frac{5L}{6}\phi$ or $\phi = \frac{3}{5}\theta$. The FBDs are shown at an arbitrary instant.

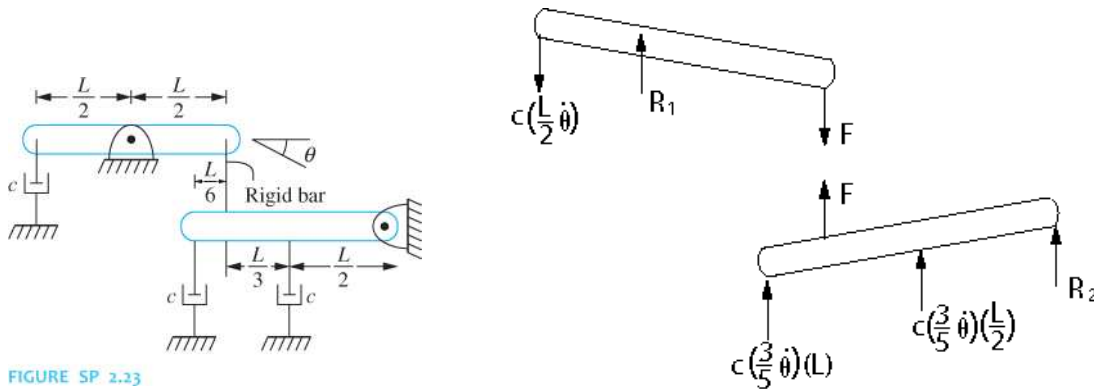

FIGURE SP 2.23

2.24 The equivalent systems method is used to derive the differential equation for linear SDOF systems. It can be used to model a linear SDOF system with an equivalent mass-spring-viscous damper model. Using a linear displacement as the generalized coordinate the equivalent mass, the equivalent stiffness, the equivalent damping viscous damping coefficient and the equivalent force are determined using the kinetic energy, potential energy, energy dissipated by viscous dampers and the work done by non-conservative forces.

2.25 Static spring forces not drawn on the FBD of external forces when they cancel with a source of potential energy for a linear system and the generalized coordinate is measured from the system's equilibrium position.

2.26 No, the equivalent systems method cannot be used for a nonlinear system.

2.27 Given: Springs of individual stiffness's k_1 and k_2 placed in series. The equivalent stiffness of the combination is $\frac{1}{\frac{1}{k_1} + \frac{1}{k_2}}$.

2.28 Given: System of Figure SP2.28. The diagrams showing the reduction to a single spring of equivalent stiffness of $\frac{8k}{3}$.

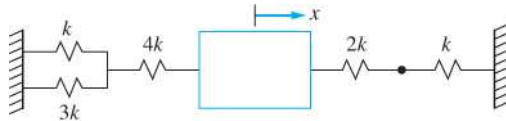
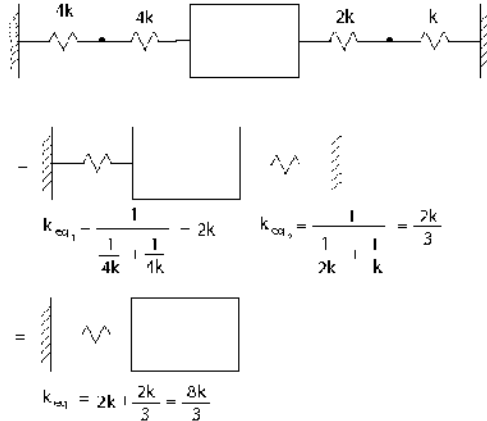

FIGURE SP 2.28



2.29 Given: System of Figure 2.29. The aluminum shaft is in series with the steel shaft (angular displacements add). The stiffness of the aluminum shaft is

$$k_{Al} = \frac{J_{Al}G_{Al}}{L_{Al}} = \frac{\frac{\pi}{2}(0.02)^4(40 \times 10^9)}{0.5} = 2.10 \times 10^4 \text{ N}\cdot\text{m/rad}$$

The stiffness of the steel shaft is $k_{St} = \frac{J_{St}G_{St}}{L_{St}} = \frac{\frac{\pi}{2}(0.015)^4(80 \times 10^9)}{0.6} =$

$1.06 \times 10^4 \text{ N}\cdot\text{m/rad}$. The equivalent stiffness is $k_{eq} = \frac{1}{1/k_{Al} + 1/k_{St}} = 6.94 \times 10^3 \text{ N}\cdot\text{m/rad}$.

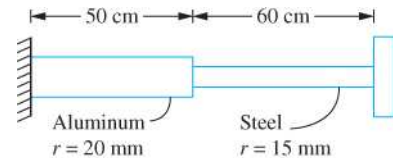

FIGURE SP 2.29

2.30 Given: $F = 300 \text{ N}$ $\Delta x = 1 \text{ mm}$. The stiffness of the element is $k = \frac{F}{\Delta x} = \frac{300 \text{ N}}{0.001 \text{ m}} = 3 \times 10^5 \text{ N/m}$.

2.31 Given: $F = 300 \text{ N}$ $\Delta x = 1 \text{ mm}$. The potential energy is $V = \frac{1}{2}k(\Delta x)^2 = \frac{1}{2}(3 \times 10^5 \text{ N/m})(0.001 \text{ m})^2 = 0.15 \text{ J}$.

2.32 Given: $F = 300 \text{ N}$ $\Delta x = 1 \text{ mm}$. The potential energy is the same for a compressive force as for a tensile force. The potential energy is $V = \frac{1}{2}k(\Delta x)^2 = \frac{1}{2}(3 \times 10^5 \text{ N/m})(0.001 \text{ m})^2 = 0.15 \text{ J}$.

2.33 Given: $k_t = 250 \text{ N} \cdot \frac{\text{m}}{\text{rad}}$, $\theta = 2^\circ$. The potential energy developed in the spring is $V = \frac{1}{2}k_t\theta^2 = \frac{1}{2}\left(250 \text{ N} \cdot \frac{\text{m}}{\text{rad}}\right)\left(2^\circ \frac{2\pi \text{ rad}}{360^\circ}\right)^2 = 0.153 \text{ J}$.

2.34 Given: $G = 80 \times 10^9 \text{ N/m}^2$, $L = 2.5 \text{ m}$, $r_i = 10 \text{ cm}$, $r_o = 15 \text{ cm}$. The polar moment of inertia is $J = \frac{\pi}{2}(r_o^4 - r_i^4) = \frac{\pi}{2}[(0.15)^4 - (0.1)^4] = 6.38 \times 10^{-4} \text{ m}^4$. The torsional stiffness of the shaft is $k_t = \frac{JG}{L} = \frac{(6.38 \times 10^{-4} \text{ m}^4)(80 \times 10^9 \text{ N/m}^2)}{2.5 \text{ m}} = 2.04 \times 10^7 \text{ N} \cdot \text{m/rad}$.

2.35 Given: $G = 40 \times 10^9 \text{ N/m}^2$, $L = 1.8 \text{ m}$, $r = 25 \text{ cm}$. The polar moment of inertia is $J = \frac{\pi}{2}r^4 = \frac{\pi}{2}(0.25)^4 = 6.12 \times 10^{-3} \text{ m}^4$. The torsional stiffness of the shaft is $k_t = \frac{JG}{L} = \frac{(6.12 \times 10^{-3} \text{ m}^4)(40 \times 10^9 \text{ N/m}^2)}{1.8 \text{ m}} = 1.36 \times 10^8 \text{ N} \cdot \text{m/rad}$.

2.36 Given: $E = 200 \times 10^9 \text{ N/m}^2$, $L = 2.3 \text{ m}$, rectangular cross-section $5 \text{ cm} \times 6 \text{ cm}$. The longitudinal stiffness of the bar is $k = \frac{AE}{L} = \frac{(0.05 \text{ m})(0.06 \text{ m})(200 \times 10^9 \text{ N/m}^2)}{2.3 \text{ m}} = 2.61 \times 10^8 \text{ N/m}$.

2.37 Given: $E = 200 \times 10^9 \text{ N/m}^2$, $L = 10 \mu\text{m}$, beam of rectangular cross section of width $1 \mu\text{m}$ and height $0.5 \mu\text{m}$. The stiffness of a cantilever beam at its end is $k = \frac{3EI}{L^3} = \frac{3(200 \times 10^9 \text{ N/m}^2)(1 \mu\text{m})(0.5 \mu\text{m})^3/12}{(10 \mu\text{m})^3} = 6.25 \text{ N/m}$.

2.38 Given: $k = 4000 \text{ N/m}$, $m = 20 \text{ kg}$. The static deflection of the spring is $\Delta_s = \frac{mg}{k} = \frac{(20 \text{ kg})(9.81 \text{ m/s}^2)}{4000 \text{ N/m}} = 4.91 \text{ cm}$

2.39 Given: $\ell = 10 \text{ cm}$, $\rho = 2.3 \text{ g/cm}$, $m = 150 \text{ g}$. The mass of the spring is $m_s = \rho\ell = (2.3 \text{ g/cm}) \left(\frac{1 \text{ kg}}{1000 \text{ g}}\right) \left(\frac{100 \text{ cm}}{\text{m}}\right) (0.1 \text{ m}) = 0.023 \text{ kg} = 23 \text{ g}$. The added mass is $m_a = \frac{m_s}{3} = 7.67 \text{ g}$.

2.40 Given: System of Figure SP2.40. The inertia effects of the springs are approximated by adding a particle of mass $m_s/3$ to the center of the disk and a particle of mass $m_s/3$ to the suspended block. The total kinetic energy of the system is $T = T_{\text{disk}} + T_{\text{pulley}} + T_{\text{block}} + T_{\text{spring1}} + T_{\text{spring2}}$. The kinetic energy of the block and the second spring is $T_{\text{block}} + T_{\text{spring2}} = \frac{1}{2}m_1\dot{x}^2 + \frac{1}{2}\frac{m_s}{3}\dot{x}^2$. The angular displacement of the pulley is $\theta = \frac{x}{r_2}$ and its kinetic energy is $T_{\text{pulley}} = \frac{1}{2}I\left(\frac{\dot{x}}{r_2}\right)^2 = \frac{1}{2}\frac{I}{r_2^2}\dot{x}^2$. The displacement of the center of the disk is $y = r_1\theta = \frac{r_1}{r_2}x$. The disk rolls

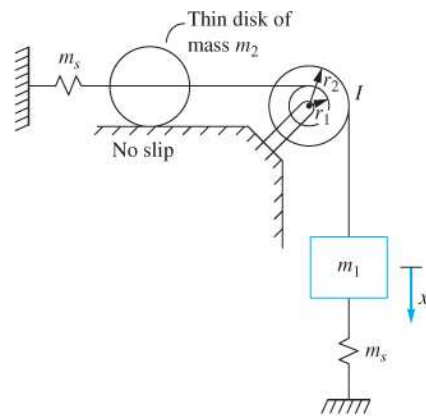

FIGURE SP2.40

Chapter 2: Modeling of SDOF Systems

without slipping, $T_{disk} = \frac{1}{2}m\bar{v}^2 + \frac{1}{2}\bar{I}\omega^2 = \frac{1}{2}m_2\dot{y}^2 + \frac{1}{2}\frac{1}{2}m_2\dot{y}^2 = \frac{1}{2}\left(\frac{3}{2}m_2\right)\left(\frac{r_1}{r_2}\dot{x}\right)^2$. The kinetic energy of the first spring is $T_{spring1} = \frac{1}{2}\frac{m_s}{3}\dot{y}^2 = \frac{1}{2}\left[\frac{m_s}{3}\left(\frac{r_1}{r_2}\right)^2\right]\dot{x}^2$. The total kinetic energy of the system is $T = \frac{1}{2}\left[m_1 + \frac{m_s}{3} + \frac{I}{r_2^2} + \frac{3}{2}m_2\left(\frac{r_1}{r_2}\right)^2 + \frac{m_s}{3}\left(\frac{r_1}{r_2}\right)^2\right]\dot{x}^2$.

2.41 Given: System of Figure SP2.41. The work done by the viscous dampers as the system rotates through an angle θ is

$$W_{1 \rightarrow 2} = -\int_0^\theta c\left(\frac{2L}{3}\dot{\theta}\right)d\left(\frac{2L}{3}\theta\right) - \int_0^\theta c\left(\frac{L}{3}\dot{\theta}\right)d\left(\frac{L}{3}\theta\right) - \int_0^\theta c\left(\frac{L}{3}\dot{\theta}\right)d\left(\frac{L}{3}\theta\right) = -\int_0^\theta c\left(\frac{2L^2}{3}\dot{\theta}\right)d\theta \Rightarrow c_{teq} = \frac{2L^2}{3}c.$$

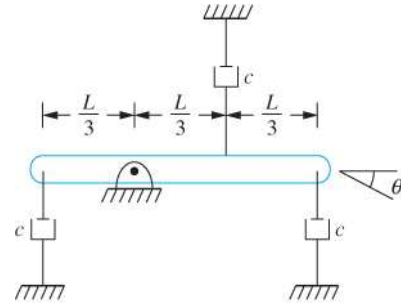

FIGURE SP2.41

2.42 (a) $\sin 0.05 = 0.05$; (b) $\cos 0.05 = 1$; (c) $1 - \cos 0.05 = (0.05)^2/2 = 0.00125$; (d) $\tan 0.05 = 0.05$; (e) $\cot 0.05 = 1/\tan 0.05 = 1/0.05 = 20$; (f) $\sec 0.05 = 1/\cos 0.05 = 1$; (g) $\csc 0.05 = 1/\sin 0.05 = 20$

2.43 (a) $\sin 3^\circ = 6\pi/360 = \pi/60$; (b) $\cos 3^\circ = 1$; (c) $1 - \cos 3^\circ = \left(\frac{\pi}{60}\right)^2$; (d) $\tan 3^\circ = \pi/60$

2.44 Given: System of Figure 2.44. The kinetic energy of the system is $T = \frac{1}{2}J_1(\dot{\theta}_1)^2 +$

$$\frac{1}{2}J_2\left(\frac{n_1}{n_2}\dot{\theta}_1\right)^2 + \frac{1}{2}J_3\left(\frac{n_1n_3}{n_2n_4}\dot{\theta}_1\right)^2 = \frac{1}{2}\left[J_1 + \left(\frac{n_1}{n_2}\right)^2J_2 + \left(\frac{n_1n_3}{n_2n_4}\right)^2J_3\right]\dot{\theta}_1 \Rightarrow J_{eq} = J_1 + \left(\frac{n_1}{n_2}\right)^2J_2 + \left(\frac{n_1n_3}{n_2n_4}\right)^2J_3$$

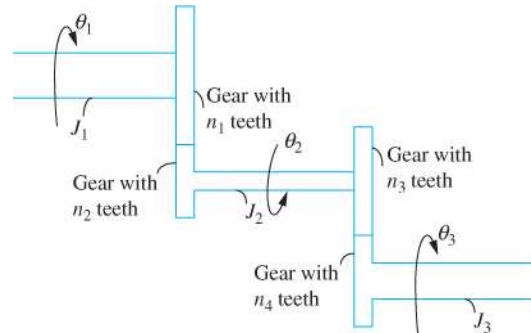
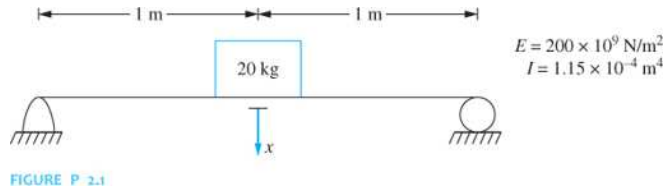

FIGURE SP 2.44

2.45 (a)-(vi); (b)-(iii); (c)-(iv); (d)-(vii); (e)-(i); (f)-(iv); (g)-(v); (h)-(ii)

Chapter Problems

2.1 Determine the equivalent stiffness of a linear spring when a SDOF mass-spring model is used for the system shown in Figure P2.1 with x being the chosen generalized coordinate.



Given: $L = 2 \text{ m}$, $E = 200 \times 10^9 \text{ N/m}^2$, $I = 1.15 \times 10^{-4} \text{ m}^4$, $m = 20 \text{ kg}$

Find: k_{eq}

Solution: The deflection of a pinned-pinned beam at its midspan is determined using Table D.2 with $a = L/2$, $Z = L/2$ as

$$y(Z = L/2) = \frac{L^3}{48EI}$$

The equivalent stiffness is the reciprocal of the deflection,

$$\begin{aligned} k_{eq} &= \frac{48EI}{L^3} \\ &= \frac{48(20 \times 10^9 \frac{\text{N}}{\text{m}^2})(1.15 \times 10^{-4} \text{ m}^4)}{(2\text{m})^3} \\ &= 1.38 \times 10^8 \frac{\text{N}}{\text{m}} \end{aligned}$$

Problem 2.1 illustrates the determination of the equivalent stiffness of a structural member.

2.2 Determine the equivalent stiffness of a linear spring when a SDOF mass-spring model is used for the systems shown in Figure P2.2 with x being the chosen generalized coordinate.

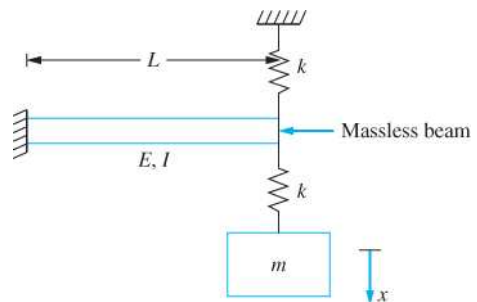

Given: k , E , I , L

Find: k_{eq}

Solution: The cantilever beam behaves as a linear spring. The displacement of the end of the upper spring and the end of the cantilever beam are the same. Thus the beam is in parallel with the upper spring. The equivalent stiffness of the cantilever beam at its end is

$$k_b = \frac{3EI}{L^3}$$

Thus the equivalent stiffness of the beam and spring in parallel is

$$k_{eq_1} = \frac{3EI}{L^3} + k$$

The total deflection of the system is the deflection of the beam plus the change in length of the lower spring. Thus the lower spring is in series with the beam and upper spring. Using the equation for a series combination of springs

$$\begin{aligned} k_{eq} &= \frac{1}{\frac{1}{k} + \frac{1}{k_{eq_1}}} \\ &= \frac{1}{\frac{1}{k} + \frac{1}{k + \frac{3EI}{L^3}}} \\ &= \frac{k \left(k + \frac{3EI}{L^3} \right)}{2k + \frac{3EI}{L^3}} \end{aligned}$$

Problem 2.2 illustrates (a) principles for determining parallel and series combination of springs and (b) use of the formulas for series and parallel spring combinations.

2.3 Determine the equivalent stiffness of a linear spring when a SDOF mass-spring model is used for the the system shown in Figure P2.3 with x being the chosen generalized coordinate.

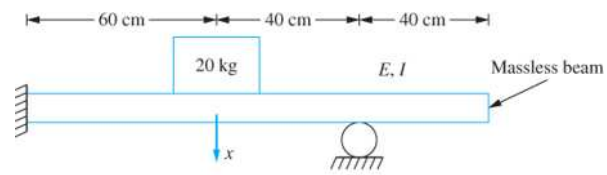

FIGURE P 2.3

Given: Fixed-pinned beam with overhang, dimensions shown

Find: k_{eq} .

Solution: The 20 kg machine is placed at A on the beam. Using the displacement of A as the generalized coordinate, the equivalent stiffness is the reciprocal of the displacement at A due to a unit concentrated load at A. From Table D2, with $a = 0.6\text{m}$, $z_1 = 1.0\text{ m}$, the displacement at A due to a unit concentrated load at A is

$$EIy(z = a) = C_1 \frac{a^3}{6} + C_2 \frac{a^2}{2} + C_3 a + C_4 \quad (1)$$

where

$$C_1 = -\frac{3}{2} + \frac{3}{2} \frac{a}{z_1} + \frac{1}{2} \left(1 - \frac{a}{z_1}\right)^3 = -.568 \quad (2)$$

$$C_2 = \frac{z_1}{2} \left(1 - \frac{a}{z_1}\right) \left[1 - \left(1 - \frac{a}{z_1}\right)^2\right] = 0.168 \quad (3)$$

$$C_3 = 0 \quad (4)$$

$$C_4 = 0 \quad (5)$$

Substituting eqs.(2)-(5) in eq.(1) leads to

$$EIy(z = 0.6) = -.538 \frac{(0.6)^3}{6} + 0.168 \frac{(0.6)^2}{2} = .01083$$

Hence the equivalent stiffness is

$$k_{eq.} = \frac{I}{y(z = 0.6)} = \frac{I}{\frac{0.01083}{EI}} = 92.3EI$$

Problem 2.3 illustrates the concept of equivalent stiffness for a one degree of freedom model of a mass attached to a beam. The equations and entries of Table D2 are used to determine the equivalent stiffness.

2.4 Determine the equivalent stiffness of a linear spring when a SDOF mass-spring model is used for the system shown in Figure P2.4 with x as the chosen generalized coordinate.

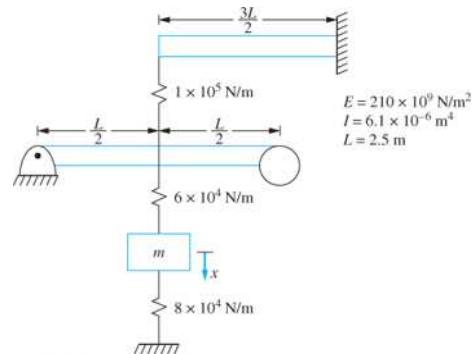

FIGURE P 2.4

Given: system shown

Solution: The stiffness of the fixed-free beam is

$$k_1 = \frac{3EI}{L^3} = \frac{3(210 \times 10^9 \text{ N/m}^2)(6.1 \times 10^{-8} \text{ m}^4)}{(2.5 \text{ m})^3} = 2.50 \times 10^5 \text{ N/m}$$

Chapter 2: Modeling of SDOF Systems

The stiffness of the pinned-pinned beam is

$$k_2 = \frac{48EI}{L^3} = \frac{48(210 \times 10^9 \text{ N/m}^2)(6.1 \times 10^{-8} \text{ m}^4)}{(2.5 \text{ m})^3} = 3.94 \times 10^6 \text{ N/m}$$

The equivalent stiffness is given by the model shown below. The upper beam acts in series with the upper spring (the displacements of the springs add to give the displacement of the midspan of the simply supported beam). The lower beam acts in series with the middle spring (their displacements add). The upper spring combination acts in parallel with the lower beam-spring combination. Both act in parallel with the spring below the mass. The equivalent stiffness of the upper beam and spring is

$$k_{1,eq} = \frac{1}{\frac{1}{3.94 \times 10^6} + \frac{1}{6 \times 10^4}} = 7.11 \times 10^4 \text{ N/m}$$

The equivalent stiffness of the lower spring and beam is

$$k_{2,eq} = \frac{1}{\frac{1}{2.5 \times 10^5} + \frac{1}{1 \times 10^5}} = 5.91 \times 10^4 \text{ N/m}$$

The equivalent stiffness of the combination is

$$k_{eq} = 7.11 \times 10^4 \frac{\text{N}}{\text{m}} + 5.91 \times 10^4 \frac{\text{N}}{\text{m}} + 8 \times 10^4 \frac{\text{N}}{\text{m}} = 2.10 \times 10^5 \text{ N/m}$$

Problem 2.4 illustrates the equivalent stiffness of a combination of springs.

2.5 Determine the equivalent stiffness of a linear spring when a SDOF mass-spring model is used for the system shown in Figure P2.5 with x as the chosen generalized coordinate.

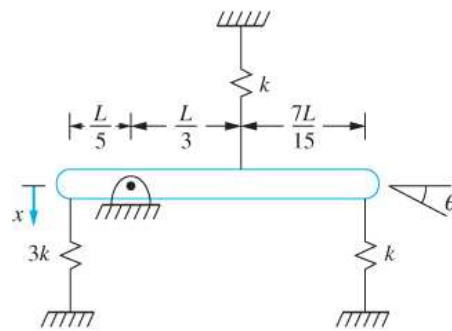

FIGURE P 2.5

Given: system shown

Given: k_{eq}

Solution: The potential energy of a spring of equivalent stiffness located at the point whose displacement is x is

$$V = \frac{1}{2} k_{eq} x^2$$

The potential energy of the system, using x as a generalized coordinate, is

$$V = \frac{1}{2} 3kx^2 + \frac{1}{2} k \left(\frac{5}{3}x\right)^2 + \frac{1}{2} k(4x)^2 = \frac{1}{2} \left(\frac{196}{9}k\right) x^2$$

Thus the equivalent stiffness is

$$k_{eq} = \frac{196}{9}k$$

Problem 2.5 illustrates the equivalence of two systems of springs using potential energy.

2.6 Determine the equivalent stiffness of a linear spring when a SDOF mass-spring model is used for the system shown in Figure P2.6 with x as the chosen generalized coordinate.

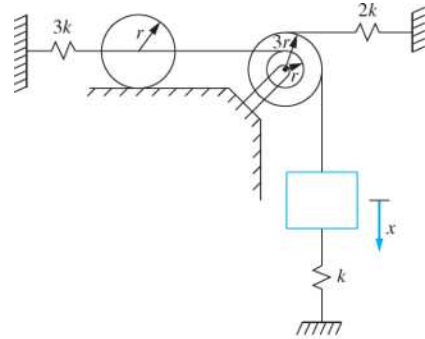

FIGURE P 2.6

Given: system shown

Given: k_{eq}

Solution: The potential energy of a spring of equivalent stiffness located at the point whose displacement is x is

$$V = \frac{1}{2} k_{eq} x^2$$

The potential energy of the system, using x as a generalized coordinate, is

$$V = \frac{1}{2} kx^2 + \frac{1}{2} 2kx^2 + \frac{1}{2} k \left(\frac{x}{3}\right)^2 = \frac{1}{2} \left(\frac{10}{9}k\right) x^2$$

Thus the equivalent stiffness is

$$k_{eq} = \frac{10}{9}k$$

Problem 2.6 illustrates the equivalence of two systems of springs using potential energy.

2.7 Determine the equivalent stiffness of a linear spring when a SDOF mass-spring model is used for the system shown in Figure P2.7 with x as the chosen generalized coordinate.

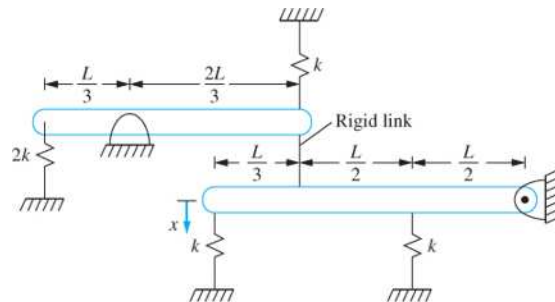

FIGURE P 2.7

Chapter 2: Modeling of SDOF Systems

Given: system shown

Given: k_{eq}

Solution: The potential energy of a spring of equivalent stiffness located at the point whose displacement is x is

$$V = \frac{1}{2}k_{eq}x^2$$

The angular displacement of the upper bar is θ , measured positive clockwise. The angular displacement of the lower bar is ϕ , measured positive counterclockwise. The particles attached to the rigid link have the same displacement

$$\frac{2L}{3}\theta = L\phi$$

Noting that

$$x = \frac{4L}{3}\phi$$

thus

$$\theta = \frac{9}{8L}x$$

The potential energy of the system, using x as a generalized coordinate, is

$$V = \frac{1}{2}kx^2 + \frac{1}{2}k\left(\frac{3x}{8}\right)^2 + \frac{1}{2}k\left(\frac{3x}{4}\right)^2 + \frac{1}{2}2k\left(\frac{3x}{8}\right) = \frac{1}{2}\left(\frac{127k}{64}\right)x^2$$

Thus the equivalent stiffness is

$$k_{eq} = \frac{127}{64}k$$

Problem 2.7 illustrates the equivalence of two systems of springs using potential energy.

2.8 Determine the equivalent stiffness of a linear spring when a SDOF mass-spring model is used for the system shown in Figure P2.8 with x as the chosen generalized coordinate.

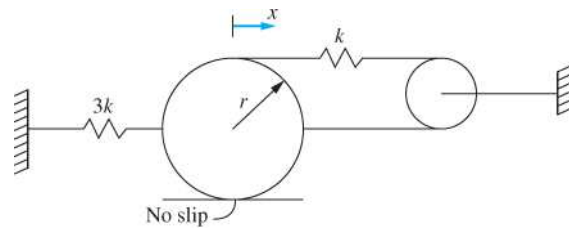

FIGURE P 2.8

Given: system shown

Given: k_{eq}

Solution: The potential energy of a spring of equivalent stiffness located at the point whose displacement is x is

$$V = \frac{1}{2}k_{eq}x^2$$

The spring attached to the disk and around the pulley has a displacement of $3x$, x from the displacement of the mass center and $2x$ (assuming no slip between the disk and the surface) from the angular rotation of the disk. The potential energy of the system, using x as a generalized coordinate, is

$$V = \frac{1}{2}3kx^2 + \frac{1}{2}k(3x)^2 = \frac{1}{2}(12k)x^2$$

Thus the equivalent stiffness is

$$k_{eq} = 12k$$

Problem 2.8 illustrates the equivalence of two systems of springs using potential energy.

2.9 Two helical coil springs are made from a steel ($E = 200 \times 10^9 \text{ N/m}^2$) bar of radius 20 mm. One spring has a coil diameter of 7 cm; the other has a coil diameter of 10 cm. The springs have 20 turns each. The spring with the smaller coil diameter is placed inside the spring with the larger coil diameter. What is the equivalent stiffness of the assembly?

Given: $E = 200 \times 10^9 \text{ N/m}^2$ (or $G = 80 \times 10^9 \text{ N/m}^2$), $r = 20 \text{ mm}$, $d_1 = 7 \text{ cm}$, $d_2 = 10 \text{ cm}$, $N_1 = N_2 = 20$

Find: k_{eq}

Solution: The stiffness of the inner spring is

$$k_1 = \frac{Gd^4}{64Nr^3} = \frac{(80 \times 10^9 \text{ N/m}^2)(0.07 \text{ m})^4}{64(20)(0.02)^3} = 1.88 \times 10^8 \text{ N/m}$$

The stiffness of the outer spring is

$$k_2 = \frac{Gd^4}{64Nr^3} = \frac{(80 \times 10^9 \text{ N/m}^2)(0.10 \text{ m})^4}{64(20)(0.02)^3} = 7.81 \times 10^8 \text{ N/m}$$

The springs act in parallel, the displacements are the same and the force on the block is the sum of the forces in the springs. Thus

$$k_{eq} = k_1 + k_2 = 1.88 \times 10^8 \frac{\text{N}}{\text{m}} + 7.81 \times 10^8 \frac{\text{N}}{\text{m}} = 9.69 \times 10^8 \frac{\text{N}}{\text{m}}$$

Chapter 2: Modeling of SDOF Systems

Problem 2.9 illustrates springs acting in parallel.

2.10 A thin disk attached to the end of an elastic beam has three uncoupled modes of vibration. The longitudinal motion, the transverse motion, and the torsional oscillations are kinematically independent. Calculate the following of Figure P2.10. (a) The longitudinal stiffness; (b) The transverse stiffness; (c) The torsional stiffness

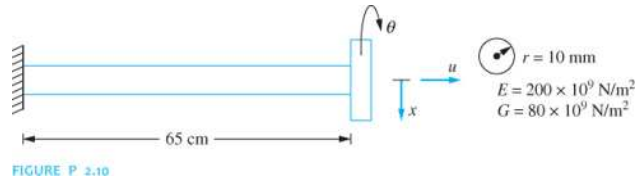

Given: $L = 65 \text{ cm}$, $r = 10 \text{ mm}$, $E = 200 \times 10^9 \text{ N/m}^2$, $G = 80 \times 10^9 \text{ N/m}^2$

Find: k_ℓ , k_θ , and k_y

Solution: The geometric properties of the beam are

$$A = \pi r^2 = \pi (0.01 \text{ m})^2 = 3.14 \times 10^{-4} \text{ m}^2$$

$$J = \frac{\pi}{2} r^4 = \frac{\pi}{2} (0.01 \text{ m})^4 = 1.57 \times 10^{-8} \text{ m}^4$$

$$I = \frac{\pi}{4} r^4 = \frac{\pi}{4} (0.01 \text{ m})^4 = 7.58 \times 10^{-9} \text{ m}^4$$

(a) The longitudinal stiffness is

$$k_\ell = \frac{AE}{L} = \frac{(3.14 \times 10^{-4} \text{ m}^2) \left(200 \times 10^9 \frac{\text{N}}{\text{m}^2} \right)}{0.65 \text{ m}} = 9.67 \times 10^7 \frac{\text{N}}{\text{m}}$$

(b) The transverse stiffness is

$$k_y = \frac{3EI}{L^3} = \frac{3 \left(200 \times 10^9 \frac{\text{N}}{\text{m}^2} \right) (7.58 \times 10^{-9} \text{ m}^4)}{(0.65 \text{ m})^3} = 1.72 \times 10^4 \frac{\text{N}}{\text{m}}$$

(c) The torsional stiffness is

$$k_\theta = \frac{JG}{L} = \frac{(1.57 \times 10^{-8} \text{ m}^4) \left(80 \times 10^9 \frac{\text{N}}{\text{m}^2} \right)}{0.65 \text{ m}} = 1930 \frac{\text{N} \cdot \text{m}}{\text{rad}}$$

Problem 2.10 illustrates three independent modes of vibration of a cantilever beam.

2.11 Find the equivalent stiffness of the springs in Figure P2.11 in the x direction.

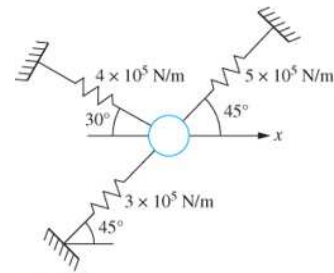
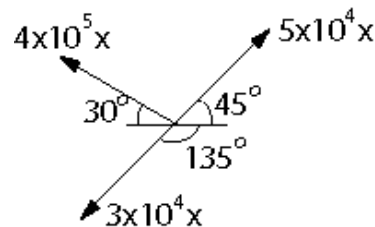

FIGURE P 2.11

Given: springs shown

Find: k_x

Solution: A FBD of the particle at an arbitrary instant is shown



Summing forces on the FBD in the x direction leads to

$$F_x = -4 \times 10^5 x(0.866) - 3 \times 10^5 x(0.707) - 5 \times 10^5 x(0.707) = -9.12 \times 10^5 x$$

Hence the equivalent stiffness in the x direction is

$$k_x = 9.12 \times 10^5 \frac{\text{N}}{\text{m}}$$

Problem 2.11 illustrates the determination of an equivalent stiffness when springs act on a particle at different angles.

2.12 A bimetallic strip used as a MEMS sensor is shown in Figure P2.12. The strip has a length of $20 \mu\text{m}$. The width of the strip is $1 \mu\text{m}$. It has an upper layer made of steel ($E = 210 \times 10^9 \text{ N/m}^2$) and a lower layer made of aluminum ($E = 80 \times 10^9 \text{ N/m}^2$). Each layer is $0.1 \mu\text{m}$ thick. Determine the equivalent stiffness of the strip in the axial direction.

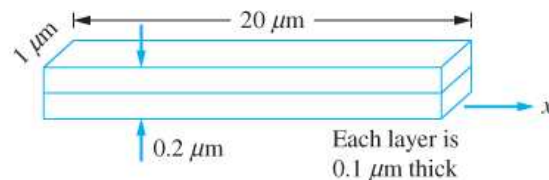

FIGURE P 2.12

Given: $L = 20 \mu\text{m}$, $w = 1 \mu\text{m}$, $E_{St} = 210 \times 10^9 \text{ N/m}^2$, $E_{Al} = 80 \times 10^9 \text{ N/m}^2$, $t = 0.1 \mu\text{m}$

Find: k_{eq}

Chapter 2: Modeling of SDOF Systems

Solution: The two layers behave as longitudinal springs in parallel. The layers have the same displacement and the forces from the layers add. The equivalent stiffness of a longitudinal spring is

$$k = \frac{EA}{L}$$

The strips have the same area and same length. The equivalent stiffness is the sum of the individual stiffnesses thus

$$k_{eq} = (E_{St} + E_{Al}) \frac{wt}{L} = \left(210 \times 10^9 \frac{\text{N}}{\text{m}^2} + 80 \times 10^9 \text{ N/m}^2 \right) \frac{(1 \mu\text{m})(0.1 \mu\text{m})}{20 \mu\text{m}} = 1450 \frac{\text{N}}{\text{m}}$$

Problem 2.12 illustrates equivalent stiffness of spring in series.

2.13 A gas spring consists of a piston of area A moving in a cylinder of gas. As the piston moves, the gas expands and contracts, changing the pressure exerted on the piston. The process occurs adiabatically (without heat transfer) so that

$$p = C\rho^\gamma$$

where p is the gas pressure, ρ is the gas density, γ is the constant ratio of specific heats, and C is a constant dependent on the initial state. Consider a spring when the initial pressure is p_0 and the initial temperature is T_0 . At this pressure, the height of the gas column in the cylinder is h . Let $F = \rho_0 A + \delta F$ be the pressure force acting on the piston when it has displaced a distance x into the gas from its initial height.

- Determine the relation between δF and x .
- Linearize the relationship of part (a) to approximate the air spring by a linear spring. What is the equivalent stiffness of the spring?
- What is the required piston area for an air spring ($\gamma = 1.4$) to have a stiffness of 300 N·m for a pressure of 150 kPa (absolute) with $h = 30$ cm.

Given: A, p_0, T_0, h, γ (c) $k=300$ N/m, $p_0 = 150$ kPa, $h=0.3$ m, $\gamma = 1.4$

Find: (a) δF and x relation (b) k (c) A

Solution: (a) The ideal gas law is used to find the density in the initial state

$$p = \rho RT \Rightarrow \rho_0 = \frac{p_0}{RT_0}$$

The initial volume of gas in the spring is

$$V_0 = Ah$$

The total mass of the air is

$$m = \rho_0 V_0 = \frac{p_0 Ah}{RT_0}$$

When the piston has moved a distance x from its equilibrium position at an arbitrary time

$$V = A(h - x)$$

Since the total mass of the gas is constant the density becomes

$$\rho = \frac{m}{V} = \frac{p_0 h}{RT_0(h - x)}$$

The initial state is defined by

$$p_0 = C \rho_0^\gamma \Rightarrow C = \frac{p_0}{\rho_0^\gamma} = p_0^{\gamma-1} (RT_0)^\gamma$$

At an arbitrary time

$$p = p_0^{\gamma-1} (RT_0)^\gamma \left(\frac{p_0 h}{RT_0(h - x)} \right)^\gamma = p_0 \left(\frac{h}{h - x} \right)^\gamma$$

(b) The force exerted on the piston is $pA = p_0 A + \delta F$. Thus

$$\delta F = p_0 A \left[\left(\frac{h}{h - x} \right)^\gamma - 1 \right]$$

But from a binomial expansion

$$\left(\frac{h}{h - x} \right)^\gamma = h \left(1 - \frac{x}{h} \right)^{-\gamma} = h \left[1 + \frac{x}{h} + O\left(\left(\frac{x}{h} \right)^2 \right) \right]$$

Thus

$$k_{eq} = \frac{\delta F}{x} = \frac{\gamma p_0 A}{h}$$

(c) Solving for A and substituting given values

$$A = \frac{k_{eq} h}{\gamma p_0} = \frac{(300 \text{ N/m})(0.3 \text{ m})}{1.4 (150000 \text{ N/m}^2)} = 4.29 \times 10^{-4} \text{ m}^2$$

Problem 2.13 illustrates the linearized stiffness for an air spring.

2.14 A wedge is floating stably on an interface between a liquid of mass density ρ , as shown in Figure P2.14. Let x be the displacement of the wedge's mass center when it is disturbed from equilibrium. (a) What is the buoyant force acting on the wedge? (b) What is the work done by the buoyant force as the mass center of the wedge moves from x_1 and x_2 ? (c) What is the equivalent stiffness of the spring if the motion of the mass center of the wedge is modeled by a mass attached to a linear spring?

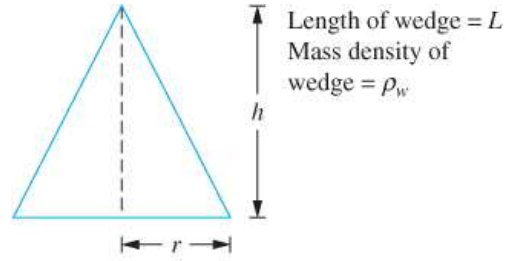
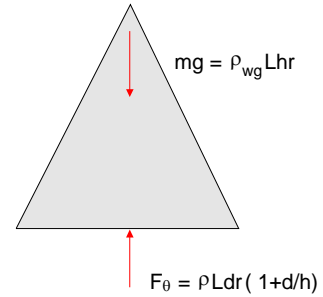

FIGURE P 2.14

Given: ρ , ρ_w , r , L , h

Find: F_B , W , linear system

Solution: (a) Consider a free-body diagram of the wedge as it floats in equilibrium on the free surface. Let d be the depth of the wedge into the liquid. In this state the buoyant force must balance with the gravity force



$$F_B - W = 0$$

$$\rho L d r \left(1 + \frac{d}{h} \right) = \rho_w g L h r$$

$$\rho_w h = \rho d \left(1 + \frac{d}{h} \right)$$

(1)

Now consider the wedge as it oscillates on the free surface. The buoyant force at an arbitrary time is

$$F_B = \rho g L (d + x) r \left(1 + \frac{d + x}{h} \right)$$

$$= \rho g L r \left[d \left(1 + \frac{d}{h} \right) + 2 \frac{d}{h} x + x + \frac{x^2}{h} \right]$$

(b) The work done by the buoyant force as the center of mass moves between x_1 and x_2 is

$$W_{1 \rightarrow 2} = \int_{x_1}^{x_2} F_B dx =$$

$$\int_{x_1}^{x_2} \rho g L r \left[d \left(1 + \frac{d}{h} \right) + 2 \frac{d}{h} x + x + \frac{x^2}{h} \right] dx$$

$$W_{1 \rightarrow 2} = \rho g L r \left[d \left(1 + \frac{d}{h} \right) (x_2 - x_1) + \frac{d}{h} (x_2^2 - x_1^2) + \frac{1}{2} (x_2^2 - x_1^2) + \frac{1}{3h} (x_2^3 - x_1^3) \right]$$

(c) The system cannot be modeled as a mass attached to a linear spring. The buoyant force is conservative. However when its potential energy function is formulated, it is not a quadratic function of the generalized coordinate.

Problem 2.14 illustrates the nonlinear oscillations of a wedge on the interface between a liquid and a gas.

2.15 Consider a solid circular shaft of length L and radius c made of an elastoplastic material whose shear stress–shear strain diagram is shown in Figure P2.15(a). If the applied torque is such that the shear stress at the outer radius of the shaft is less than τ_p , a linear relationship between the torque and angular displacement exists. When the applied torque is large enough to cause plastic behavior, a plastic shell is developed around an elastic core of radius $r < c$, as shown in Figure P2.15(b). Let

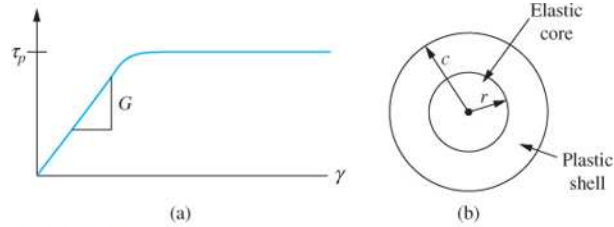

FIGURE P 2.15

be the applied torque which results in an angular displacement of

$$T = \frac{\pi \tau_p c^2}{2} + \delta T \quad (1)$$

be the applied torque which results in an angular displacement of

$$\theta = \frac{\tau_p L}{cG} + \delta \theta \quad (2)$$

(a) The shear strain at the outer radius of the shaft is related to the angular displacement

$$\theta = \frac{\gamma_c L}{c} \quad (3)$$

The shear strain distribution is linear over a given cross section. Show that this implies

$$\theta = \frac{L \tau_p}{rG} \quad (4)$$

(b) The torque is the resultant moment of the shear stress distribution over the cross section of the shaft,

$$T = \int_0^c 2\pi r \tau^2 dr \quad (5)$$

Use this to relate the torque to the radius of the elastic core.

(c) Determine the relationship between δT and $\delta \theta$.

(d) Approximate the stiffness of the shaft by a linear torsional spring. What is the equivalent torsional stiffness?

Chapter 2: Modeling of SDOF Systems

Given: stress-strain diagram, $\tau > \tau_p$

Find: Show eq. (4), linear approximation to stiffness

Solution: (a) The shear stress is linear in the elastic core and at $\rho = r$, $\gamma = \tau_p/G$. The shear strain is linear throughout the cross section. Thus

$$\gamma = \frac{\tau_p \rho}{rG} \quad (6)$$

Then evaluating eq. (6) at $\rho = c$ and using eq. (3)

$$\begin{aligned} \gamma_c &= \frac{\tau_p C}{rG} = \frac{c\theta}{L} \\ \theta &= \frac{\tau_p L}{rG} \end{aligned}$$

(b) The shear stress distribution over the cross section is shown. The resisting torque is the resultant moment of the shear stress distribution. But

$$\tau = \begin{cases} \tau_p \frac{\rho}{r}, & 0 \leq \rho \leq r \\ \tau_p, & r \leq \rho \leq c \end{cases}$$

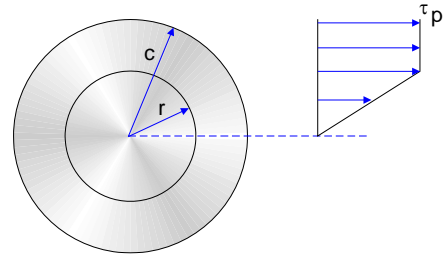

Hence from eq.(5)

$$\begin{aligned} T &= \int_0^r \left(\tau_p \frac{\rho}{r} \right) 2\pi \tau_p \rho^2 d\rho + \int_x^c \tau_p 2\pi \rho^2 d\rho \\ &= 2\pi \tau_p \left(\frac{c^3}{3} - \frac{r^3}{12} \right) \end{aligned} \quad (7)$$

(c) Equating the torques from eq. (1) and eq. (7)

$$\begin{aligned} 2\pi \tau_p \left(\frac{c^3}{3} - \frac{r^3}{12} \right) &= \pi \tau_p \frac{c^3}{2} + \delta T \\ \delta T &= \pi \frac{\tau_p}{6} (c^3 - r^3) \\ r &= \left(c^3 - \frac{6\delta T}{\pi \tau_p} \right)^{\frac{1}{3}} \end{aligned} \quad (8)$$

Equating the angular displacement. from eqs. (2) and (4)

$$\frac{\tau_p L}{cG} + \delta\theta = \frac{\tau_p L}{rG} \quad (9)$$

Substituting eq.(8) into eq.(9)

$$\frac{\tau_p L}{cG} + \delta\theta = \frac{\tau_p L}{G \left(c^3 - \frac{6\delta T}{\pi\tau_p} \right)^{\frac{1}{3}}} \quad (10)$$

(d) Note that

$$\left(c^3 - \frac{6\delta T}{\pi\tau_p} \right)^{-\frac{1}{3}} = \frac{1}{c} \left(1 - \frac{6\delta T}{\pi\tau_p c^3} \right)^{-\frac{1}{3}}$$

Then using the binomial theorem assuming small δT and keeping only the first two terms leads to

$$\left(c^3 - \frac{6\delta T}{\pi\tau_p} \right)^{-\frac{1}{3}} = \frac{1}{c} \left(1 + \frac{2\delta T}{\pi\tau_p c^3} \right) \quad (11)$$

Substituting eq.(11) in eq. (10) leads to

$$\frac{\tau_p L}{cG} + \delta\theta = \frac{\tau_p L}{cG} \left(1 + \frac{2\delta T}{\pi\tau_p c^3} \right)$$

or

$$\delta\theta = \frac{2\delta T L}{\pi c^4 G}$$

$$\frac{\delta T}{\delta\theta} = \frac{\pi c^4 G}{2L} = \frac{JG}{L}$$

The above approximation neglected terms involving powers of δT when the binomial expansion was performed. Thus, a linear approximation to the stiffness is the same as the linear stiffness.

Problem 2.15 illustrates a linear approximation to torsional stiffness for an elastoplastic material when the elastic shear stress is exceeded.

Chapter 2: Modeling of SDOF Systems

2.16 A bar of length L and cross-sectional area A is made of a material whose stress-strain diagram is shown in Figure P2.16. If the internal force developed in the bar is such that $\sigma < \sigma_p$, then the bar's stiffness for a SDOF model is

$$k = \frac{AE}{L}$$

Consider the case when $\sigma > \sigma_p$. Let $P = \sigma_p A + \delta P$ be the applied load which results in a deflection $\Delta = \frac{\sigma_p L}{E} + \delta \Delta$.

(a) The work done by the applied force is equal to the strain energy developed in the bar. The strain energy per unit volume is the area under the stress-strain curve. Use this information to relate δP to $\delta \Delta$.

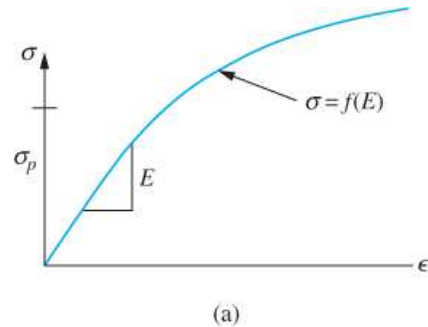

FIGURE P 2.16

(b) What is the equivalent stiffness when the bar is approximated as a linear spring for $\sigma > \sigma_p$?

Given: stress-strain curve, δP , E , σ_p

Find: $\delta \Delta = f(\delta P)$, linear stiffness approximation

Solution: The work done by application of a force P , resulting in a deflection Δ is

$$W = \frac{1}{2} P \Delta \tag{1}$$

When the stress exceeds the proportional limit, the work is written as

$$W = \frac{1}{2} (\sigma_p A + \delta P) \left(\frac{\sigma_p L}{E} + \delta \Delta \right)$$

The work is also the area under the P- Δ curve.

$$W = \frac{1}{2} (\sigma_p A) \left(\sigma_p \frac{L}{E} \right) + \int_{\frac{\sigma_p}{E}}^{\frac{\sigma_p + \delta \Delta}{E} + \frac{L}{L}} ALf(\epsilon) d\epsilon \tag{2}$$

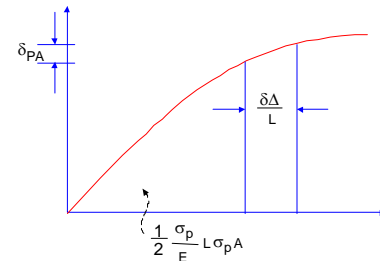

Equating the work from eqs.(1) and (2) leads to

$$\frac{1}{2} \delta P \sigma_p \frac{L}{E} + \frac{1}{2} \sigma_p A \delta \Delta + \frac{1}{2} \delta P \delta \Delta = \int_{\frac{\sigma_p}{E}}^{\frac{\sigma_p + \delta \Delta}{E} + \frac{L}{L}} ALf(\epsilon) d\epsilon \tag{3}$$

(b) If $\delta\Delta$ is small, then so is δP . Hence the term with their product is much smaller than the other terms in eq. (3) and is neglected. In addition the mean value theorem is used to approximate the integral

$$\int_{\frac{\sigma_P}{E}}^{\frac{\sigma_P + \delta\Delta}{E}} ALf(\epsilon) d\epsilon = \frac{\delta\Delta}{L} ALf(\tilde{\epsilon})$$

where

$$\frac{\sigma_P}{E} \leq \tilde{\epsilon} \leq \frac{\sigma_P}{E} + \frac{\Delta\delta}{E}$$

Then eq. (5) becomes

$$\frac{1}{2} \delta P \sigma_P \frac{L}{E} + \frac{1}{2} \sigma_P A \delta\Delta + \frac{1}{2} \delta P \delta\Delta = A \delta\Delta f(\tilde{\epsilon})$$

Dividing by $\delta\Delta$ leads to

$$\frac{\delta P}{\delta\Delta} = -\frac{AE}{L} + \frac{2AE}{L\sigma_P} f(\tilde{\epsilon})$$

If the limit as $\delta\Delta \rightarrow 0$ is taken then

$$\begin{aligned} \tilde{\epsilon} &\rightarrow \frac{\sigma_P}{E} \\ f(\tilde{\epsilon}) &\rightarrow \sigma_P \end{aligned}$$

and

$$\frac{\delta P}{\delta\Delta} \rightarrow \frac{AE}{L}$$

Problem 2.16 illustrates the linear approximation to the stiffness when the elastic strength is exceeded for a bar undergoing longitudinal oscillations.

2.17 Calculate the static deflection of the spring in the system of Figure P2.17.

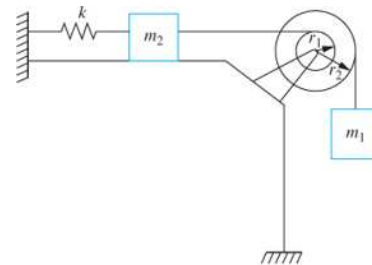

FIGURE P 2.17

Chapter 2: Modeling of SDOF Systems

Given: k, m_1, m_2, r_1, r_2

Find: Δ_{ST}

Solution: Summing moments about the center of the pulley using the free body diagram of the system when it is in equilibrium,

$$\begin{aligned} \sum M_o &= 0 \\ &= m_1 g r_2 - k \Delta_{ST} r_1 \\ \Delta_{ST} &= \frac{m_1 g r_2}{k r_1} \end{aligned}$$

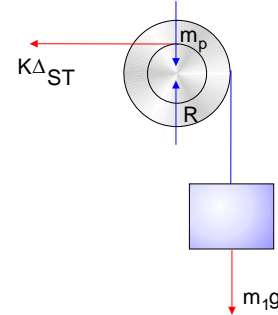

Problem 2.17 illustrates calculation of the static deflection of a spring.

2.18 Determine the static deflection of the spring in the system of Figure P2.18.

Given: $L = 1.6 \text{ m}$, $a = 1.2 \text{ m}$, $m = 20 \text{ kg}$, $k = 5 \times 10^3 \text{ N/m}$, spring is stretched 20 mm when bar is vertical.

Find: Δ_{ST} .

Solution: A free body diagram of the bar in its static equilibrium position is shown. It is assumed the spring force is horizontal. The equilibrium position is defined by θ_{ST} , the clockwise angle made by the bar with the vertical. Summing moments about the support

$$\sum M_o = 0$$

leads to

$$-mg \left(a - \frac{L}{2} \right) \sin \theta_{ST} + k(a \sin \theta_{ST} - \delta) a \cos \theta_{ST} = 0$$

Substituting given values and rearranging leads to

$$\tan \theta_{ST} = 91.74 \sin \theta_{ST} - 1.53$$

The above equation is solved by trial and error for θ_{ST} , yielding

$$\theta_{ST} = 0.965^\circ = 0.0168 \text{ rad}$$

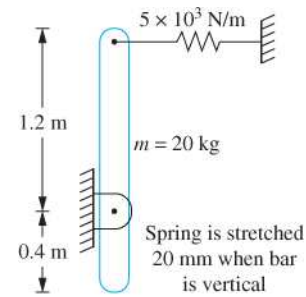
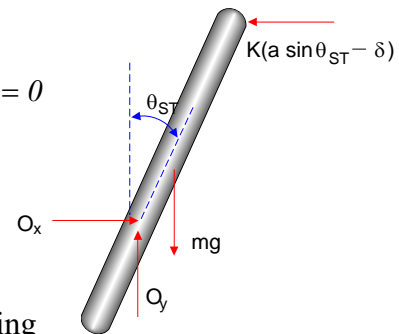

FIGURE P 2.18



The static deflection in the spring is given by

$$\Delta_{ST.} = a \sin \theta_{ST.} - \delta = 0.22\text{mm}$$

Problem 2.18 illustrates the application of the equations of equilibrium to determine the static equilibrium position for a given system. The assumption that the spring force is horizontal is good, in light of the result. Equation (1) was solved by trial and error. An alternate method is to approximate $\tan \theta$ by θ and $\sin \theta$ by θ .

2.19 A simplified SDOF model of a vehicle suspension system is shown in Figure P2.19. The mass of the vehicle is 500 kg. The suspension spring has a stiffness of 100,000 N/m. The wheel is modeled as a spring placed in series with the suspension spring. When the vehicle is empty, its static deflection is measured as 5 cm.

- (a) Determine the equivalent stiffness of the wheel
- (b) Determine the equivalent stiffness of the spring combination

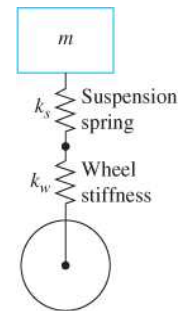

FIGURE P 2.19

Given: $m = 500 \text{ kg}$, $k_s = 100,000 \text{ N/m}$, $\delta = 5 \text{ cm}$

Find: (a) k_w (b) k_{eq}

Solution: (a) The wheel is in series with the suspension spring. The force developed in each spring is the same while the total displacement of the series combination is the sum of the displacements of the individual springs. When the system is in equilibrium, the springs are subject to the empty weight of the vehicle. Hence the force developed in each spring is equal to the weight of the vehicle $W = mg = (500 \text{ kg})(9.81 \text{ m/s}^2) = 4.905 \times 10^3 \text{ N}$. The total displacement in the two springs is 5 cm,

$$\delta_w + \delta_s = 5 \text{ cm}$$

But the force developed in a linear spring is $k\delta$. Thus

$$\frac{mg}{k_s} + \frac{mg}{k_w} = 5 \text{ cm}$$

Solving for k_w leads to

$$\frac{1}{k_w} = \frac{\delta}{mg} - \frac{1}{k_s} = \frac{0.05 \text{ m}}{4.905 \times 10^3 \text{ N}} - \frac{1}{100,000 \text{ N/m}}$$

$$k_w = 5.16 \times 10^6 \text{ N/m}$$

- (b) The equivalent stiffness of the series combination is

Chapter 2: Modeling of SDOF Systems

$$k_{eq} = \frac{1}{\frac{1}{k_s} + \frac{1}{k_w}} = \frac{1}{\frac{1}{1 \times 10^5 \text{ N/m}} + \frac{1}{5.16 \times 10^6 \text{ N/m}}}$$

$$k_{eq} = 9.63 \times 10^4 \text{ N/m}$$

Problem 2.19 illustrates the equivalent stiffness of two springs placed in series.

2.20 The spring of the system in Figure P2.20 is unstretched in the position shown. What is the deflection of the spring when the system is in equilibrium?

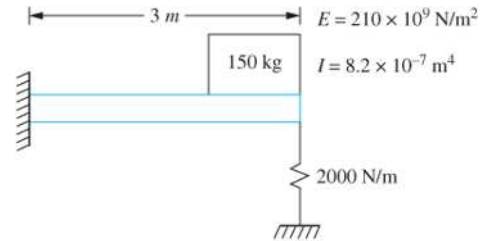

FIGURE P 2.20

Given: $m = 150 \text{ kg}$, $k = 2000 \text{ N/m}$,
 $E = 210 \times 10^9 \text{ N/m}^2$, $I = 8.2 \times 10^{-7} \text{ m}^4$, $L = 3 \text{ m}$

Find: Δ_{st}

Solution: The system behaves as two springs in parallel. The beam has the same displacement as the spring. The equivalent stiffness is

$$k_{eq} = k_b + k = \frac{3EI}{L^3} + k = \frac{3(210 \times 10^9 \text{ N/m}^2)(8.2 \times 10^{-7} \text{ m}^4)}{(3 \text{ m})^3} + 2000 \frac{\text{N}}{\text{m}} = 2.11 \times 10^4 \text{ N/m}$$

The static deflection of the system is

$$\Delta_{st} = \frac{mg}{k_{eq}} = \frac{(150 \text{ kg})(9.81 \text{ m/s}^2)}{2.11 \times 10^4 \text{ N/m}} = 6.97 \text{ cm}$$

Problem 2.20 illustrates springs in parallel and static deflection.

2.21 Determine the static deflection of the spring in the system of Figure P2.21.

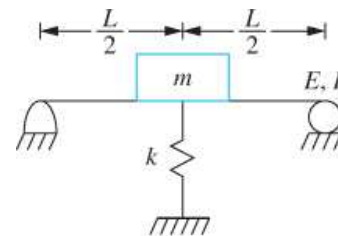

FIGURE P 2.21

Given: m , k , E , I , L

Find: Δ_{st}

Solution: The system behaves as two springs in parallel. The beam has the same displacement as the spring. The equivalent stiffness is

$$k_{eq} = k_b + k = \frac{48EI}{L^3} + k$$

The static deflection is

$$\Delta_{st} = \frac{mg}{k_{eq}} = \frac{mg}{\frac{48EI}{L^3} + k} = \frac{mgL^3}{48EI + kL^3}$$

Problem 2.21 illustrates the concepts of springs in parallel and static deflection of springs.

2.22 Determine the static deflections in each of the springs in the system of Figure P2.22.

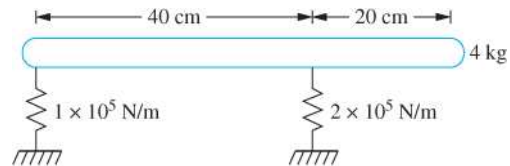
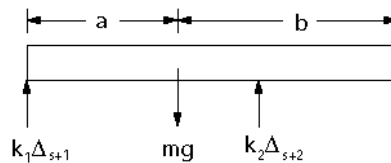

FIGURE P 2.22

Given: $k_1 = 1 \times 10^5$ N/m, $k_2 = 2 \times 10^5$ N/m,
 $m = 4$ kg, $a = 0.4$ m, $b = 0.2$ m

Find: Δ_{st1} , Δ_{st2}

Solution: A FBD of the system is shown when the system is in equilibrium



Summing forces on the FBD leads to

$$\sum F = 0 = k_1\Delta_{st1} + k_2\Delta_{st2} - mg$$

Summing moments about the mass center yields

$$\sum M_G = 0 = -k_1\Delta_{st1}(a) + k_2\Delta_{st2}(b)$$

Solution of the equations leads to

$$\Delta_{st1} = \frac{mg}{k_1 \left(1 + \frac{a}{b}\right)} = \frac{(4 \text{ kg})(9.81 \text{ m/s}^2)}{(1 \times 10^5 \text{ N/m}) \left(1 + \frac{0.4 \text{ m}}{0.2 \text{ m}}\right)} = 0.131 \text{ mm}$$

$$\Delta_{st2} = \frac{mg}{k_2 \left(1 + \frac{b}{a}\right)} = \frac{(4 \text{ kg})(9.81 \text{ m/s}^2)}{(2 \times 10^5 \text{ N/m}) \left(1 + \frac{0.2 \text{ m}}{0.4 \text{ m}}\right)} = 0.131 \text{ mm}$$

Problem 2.22 illustrates the determination of static deflections from the equations of static equilibrium.

Chapter 2: Modeling of SDOF Systems

2.23 A 30 kg compressor sits on four springs, each of stiffness 1×10^5 N/m. What is the static deflection of each spring?

Given: $m = 30$ kg, $k = 1 \times 10^5$ N/m, $n = 4$

Find: Δ_{st}

Solution: The compressor sits on four identical springs. Thus the equivalent stiffness of the springs is that of four springs in parallel or

$$k_{eq} = 4k = 4(1 \times 10^5 \text{ N/m}) = 4 \times 10^5 \text{ N/m}$$

The static deflection of the compressor is

$$\Delta_{st} = \frac{mg}{k_{eq}} = \frac{(30 \text{ kg})(9.81 \text{ m/s}^2)}{4 \times 10^5 \text{ N/m}} = 0.736 \text{ mm}$$

Problem 2.23 illustrates the static deflection of a machine mounted on four springs in parallel.

2.24 The propeller of a ship is a tapered circular cylinder, as shown in Figure P2.24. When installed in the ship, one end of the propeller is constrained from longitudinal motion relative to the ship while a 500-kg propeller mass is attached to its other end. (a) Determine the equivalent longitudinal stiffness of the shaft for a SDOF model. (b) Assuming a linear displacement function along the shaft, determine the equivalent mass of the shaft to use in a SDOF model.

Given: $r_0 = 30$ cm, $r_1 = 20$ cm, $E = 210 \times 10^9$ N/m², $m_p = 500$ kg,

$\rho = 7850$ kg/m³, $L = 10$ m

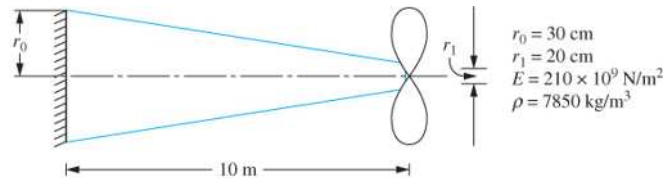

FIGURE P 2.24

Find: k_{eq} , m_{eq}

Solution: The equivalent system is that of a mass m_{eq} attached to a linear spring of stiffness k_{eq} . The equivalent mass is calculated to include inertia effects of the shaft.

The equivalent stiffness is the reciprocal of the deflection at the end of the shaft due to the application of a unit force. From strength of materials, the change in length of the shaft due to a unit load is

$$\delta = \int_0^L \frac{dx}{AE}$$

Let x be a coordinate along the axis of the shaft, measured from its fixed end. Then

$$r(x) = r_0 - \frac{r_0 - r_1}{L}x = 0.3 - 0.01x$$

is the local radius of the shaft. Thus

$$\delta = \int_0^L \frac{dx}{\pi(0.3 - 0.01x)^2 E} = \frac{53.05}{E}$$

Hence the equivalent stiffness is

$$k_{eq} = \frac{E}{53.05} = 3.96 \times 10^9 \frac{\text{N}}{\text{m}}$$

Let $u(x)$ represent the displacement of a particle in the cross section a distance x from the fixed end due to a load P applied at the end. From strength of materials

$$\begin{aligned} u(x) &= \int_0^x \frac{P dx}{AE} = \int_0^x \frac{P dx}{\pi E (0.3 - 0.01x)^2} \\ &= \frac{x}{0.3 - 0.01x} \frac{10P}{3\pi E} \end{aligned}$$

Let $z = u(L)$, then

$$\begin{aligned} z &= \frac{10}{0.2} \frac{10P}{3\pi E} = 50 \frac{10P}{3\pi E} \\ \frac{10P}{3\pi E} &= \frac{z}{50} \\ u(x) &= \frac{z}{50} \frac{x}{0.3 - 0.01x} \end{aligned}$$

Consider a differential element of mass $dm = \rho A dx$, located a distance x from the fixed end. The kinetic energy of the differential element is

$$dT = \frac{1}{2} \dot{u}^2(x) \rho A(x) dx$$

The total kinetic energy of the shaft is

$$\begin{aligned}
 T &= \frac{1}{2} \int_0^L \dot{u}^2(x) \rho A(x) dx \\
 &= \frac{\rho}{2} \int_0^{10m} \left(\frac{\dot{z}}{50} \right)^2 \left(\frac{x}{0.3 - 0.01x} \right)^2 \pi (0.3 - 0.01x)^2 dx \\
 &= \frac{\pi \rho \dot{z}^2}{5000} \int_0^{10m} x^2 dx \\
 &= \frac{1}{2} \frac{1000 \rho \pi}{3(2500)} \dot{z}^2 \\
 &= \frac{1}{2} (3288 \text{ kg}) \dot{z}^2
 \end{aligned}$$

Hence the equivalent mass is 3288 kg.

Problem 2.24 illustrates the modeling of a non-uniform structural element using one-degree-of-freedom

2.25 (a) Determine the equivalent torsional stiffness of the propeller shaft of Problem 2.24. (b) Determine an equivalent moment of inertia of the shaft to be placed on the end of the shaft for a SDOF model of torsional oscillations.

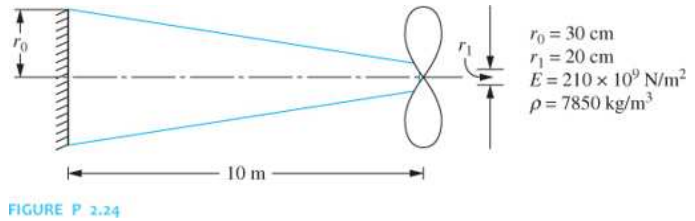

Given: $r_0 = 30 \text{ cm}$, $r_1 = 20 \text{ cm}$, $E = 80 \times 10^9 \text{ N/m}^2$, $m_p = 500 \text{ kg}$, $\rho = 7350 \text{ kg/m}^3$, $L = 10 \text{ m}$

Find: k_{teq} , I_{eq}

Solution: The equivalent system is that of a disk of moment of inertia I_{eq} attached to a torsional spring of stiffness k_{teq} . The equivalent mass is calculated to include inertia effects of the shaft.

The equivalent stiffness is the reciprocal of the deflection at the end of the shaft due to the application of a unit force. From strength of materials, the change in length of the shaft due to a unit load is

$$\theta = \int_0^L \frac{dx}{JG}$$

Let x be a coordinate along the axis of the shaft, measured from its fixed end. Then

$$r(x) = r_0 - \frac{r_0 - r_1}{L}x = 0.3 - 0.01x$$

is the local radius of the shaft. Thus the moment of inertia of the shaft is $J(x) = \frac{\pi}{2}r^4(x)$

$$\theta = \int_0^L \frac{2dx}{\pi(0.3 - 0.01x)^4 G} = \frac{1866}{G}$$

Hence the equivalent stiffness is

$$k_{eq} = \frac{G}{1866} = 4.28 \times 10^7 \text{ N} \cdot \text{m/rad}$$

Let $\theta(x)$ represent the displacement of a particle in the cross section a distance x from the fixed end due to a moment M applied at the end. From strength of materials

$$\begin{aligned} \theta(x) &= \int_0^x \frac{M dx}{JG} = \int_0^x \frac{2M dx}{\pi G(0.3 - 0.01x)^4} \\ &= \left(\frac{1}{(0.3 - 0.01x)^3} - \frac{1}{0.3^3} \right) \frac{20M}{3\pi G} \end{aligned}$$

Let $z = \theta(L)$, then

$$\begin{aligned} z &= 87.96 \frac{20MP}{3\pi G} \\ \theta(x) &= \frac{z}{87.96} \left(\frac{1}{(0.3 - 0.01x)^3} - \frac{1}{0.3^3} \right) \end{aligned}$$

Consider a differential element of mass, located a distance x from the fixed end. The kinetic energy of the differential element is

$$dT = \frac{1}{2} \dot{\theta}^2(x) \rho J(x) dx$$

The total kinetic energy of the shaft is

$$T = \frac{1}{2} \int_0^L \left(\frac{\dot{z}}{87.96} \right)^2 \left[\frac{1}{(0.3 - 0.01x)^6} - \frac{2}{0.3^3(0.3 - 0.01x)^3} + \frac{1}{0.3^6} \right] \rho \frac{\pi}{2} (0.3 - 0.01x)^4 dx$$

The equivalent moment of inertia is determined from

$$T = \frac{1}{2} I_{eq} \dot{z}^2 = \frac{1}{2} (392.5 \text{ kg} \cdot \text{m}^2) \dot{z}^2$$

Chapter 2: Modeling of SDOF Systems

Problem 2.25 illustrates the modeling of a non-uniform structural element using one-degree-of-freedom

2.26 A tightly wound helical coil spring is made from an 1.88-mm diameter bar made from 0.2 percent hardened steel ($G = 80 \times 10^9 \text{ N/m}^2$, $\rho = 7600 \text{ kg/m}^3$). The spring has a coil diameter of 1.6 cm with 80 active coils. Calculate (a) the stiffness of the spring, (b) the static deflection when a 100 g particle is hung from the spring, and (c) the equivalent mass of the spring for a SDOF model.

Given: $G = 80 \times 10^9 \text{ N/m}^2$, $\rho = 7600 \text{ kg/m}^3$, $D = 1.88 \text{ mm}$, $r = 8 \text{ mm}$, $N = 80$, $m = 100 \text{ g}$

Find: (a) Δ_{st} (b) m_{eq}

Solution: The stiffness of the helical coil spring is

$$k = \frac{GD^4}{64Nr^3}$$

$$k = \frac{(80 \times 10^9 \text{ N/m}^2)(0.00188 \text{ m})^4}{64(80)(0.008 \text{ m})^3}$$

$$k = 381.2 \text{ N/m}$$

When the 100-g particle is hung from the spring its static deflection is

$$\Delta_{st} = \frac{mg}{k} = 3.8 \text{ mm}$$

(b) The total mass of the spring is

$$m_s = \rho(2\pi Nr) \frac{1}{4} \pi D^2$$

$$m_s = 77.8 \text{ g}$$

The equivalent mass of the system is

$$m_{eq} = m + \frac{1}{3} m_s$$

$$m_{eq} = 125.9 \text{ g}$$

Problem 2.26 illustrates (a) the stiffness of a helical coil spring, (b) the static deflection of a spring, and (c) the equivalent mass of a spring used to approximate its inertia effects.

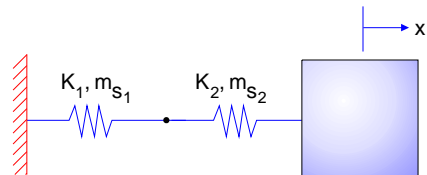

2.27 One end of a spring of mass m_{s1} and stiffness k_1 is connected to a fixed wall, while the other end is connected to a spring of mass m_{s2} and stiffness k_2 . The other end of the second spring is connected to a particle of mass m . Determine the equivalent mass of these two springs.

Given: k_1, m_{s1}, k_2, m_{s2}

Find: m_{eq}

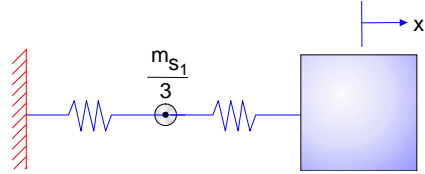

Solution: Let x be the displacement of the block to which the series combination of springs is attached. The inertia effects of the left spring can be approximated by placing a particle of mass $m_{s1}/3$ at the joint between the two springs. Define a coordinate z_1 , measured along the axis of the left spring and a coordinate z_2 , measured along the axis of the right spring. Let $u_1(z_1)$ be the displacement function the left spring and $u_2(z_2)$ be the displacement function in the right spring. It is assumed that the springs are linear and the displacements are linear,

$$\begin{aligned} u_1(z_1) &= az_1 + b \\ u_2(z_2) &= cz_2 + d \end{aligned} \quad (1)$$

where the constants $a, b, c,$ and d are determined from the following conditions

(a) Since the left end of the left spring is attached to the wall

$$u_1(0) = 0$$

This immediately yields $b = 0$.

(b) The right end of the right spring is attached to the block which has a displacement x

$$u_2(\ell_2) = x \quad (2)$$

where ℓ_2 is the unstretched length of the right spring.

(c) The displacement is continuous at the intersection between the two springs.

$$u_1(\ell_1) = u_2(0) \quad (3)$$

where ℓ_1 is the unstretched length of the left spring.

(d) Since the springs are in series, the forces developed in the springs must be the same.

$$k_1 u_1(\ell_1) = k_2 [u_2(\ell_2) - u_2(0)] \quad (4)$$

Using eq. (2)-(4) in eq. (1) leads to

Chapter 2: Modeling of SDOF Systems

$$a = \frac{x}{\ell_1} \frac{k_2}{k_1 + k_2}$$

$$c = \frac{x}{\ell_2} \frac{k_1}{k_1 + k_2}$$

$$d = \frac{k_2 x}{k_1 + k_2}$$

The kinetic energy of the left spring is

$$T_1 = \frac{1}{2} \frac{m_{s1}}{3} \dot{u}_1^2 (\ell_2) = \frac{1}{2} \frac{m_{s1}}{3} \left(\frac{k_2}{k_1 + k_2} \right)^2 \dot{x}^2$$

Thus the contribution to the equivalent mass from the left spring is

$$m_{eq1} = \frac{m_{s1}}{3} \left(\frac{k_2}{k_1 + k_2} \right)^2$$

The displacement function in the right spring becomes

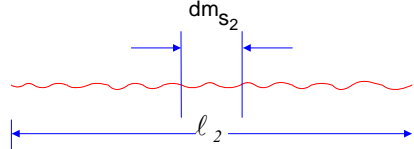
$$u_2(z_2) = \frac{x}{k_1 + k_2} \left(k_1 \frac{z_2}{\ell_2} + k_2 \right)$$

Consider a differential element of length dz_2 in the right spring, a distance z_2 from the spring's left end. The kinetic energy of the element is

$$dT_2 = \frac{1}{2} \frac{m_{s2}}{\ell_2} \dot{u}_2^2 (z_2) dz_2$$

The total kinetic energy of the spring is

$$T_2 = \frac{1}{2} \frac{m_{s2}}{\ell_2} \frac{\dot{x}^2}{(k_1 + k_2)^2} \int_0^{\ell_2} \left(k_1 \frac{z}{\ell_2} + k_2 \right)^2 dz_2$$

$$= \frac{1}{2} \frac{m_{s2}}{3} \frac{(k_1 + k_2)^3 - k_2^3}{k_1 (k_1 + k_2)^2}$$

Hence the equivalent mass of the series spring combination is

$$m_{eq} = \frac{1}{3(k_1 + k_2)^2} \left\{ k_2^2 m_{s1} + k_1^2 m_{s2} \left[\left(1 + \frac{k_2}{k_1} \right)^3 - \left(\frac{k_2}{k_1} \right)^3 \right] \right\}$$

Problem 2.27 illustrates the equivalent mass of springs in series.

2.28 A block of mass m is connected to two identical springs in series. Each spring has a mass m and a stiffness k . Determine the equivalent mass of the two springs at the mass.

Given: Two identical springs in series

Find: m_{eq}

Solution: Let x be the displacement of the block to which the series combination of springs is attached. The inertia effects of the left spring can be approximated by placing a particle of mass $m_s/3$ at the joint between the two springs. Define a coordinate z_1 , measured along the axis of the left spring and a coordinate z_2 , measured along the axis of the right spring. Let $u_1(z_1)$ be the displacement function the left spring and $u_2(z_2)$ be the displacement function in the right spring. It is assumed that the springs are linear and the displacements are linear,

$$\begin{aligned} u_1(z_1) &= az_1 + b \\ u_2(z_2) &= cz_2 + d \end{aligned} \quad (1)$$

where the constants a , b , c , and d are determined from the following conditions

(a) Since the left end of the left spring is attached to the wall

$$u_1(0) = 0$$

This immediately yields $b = 0$.

(b) The right end of the right spring is attached to the block which has a displacement x

$$u_2(\ell) = x \quad (2)$$

where ℓ_2 is the unstretched length of the right spring.

(c) The displacement is continuous at the intersection between the two springs.

$$u_1(\ell) = u_2(0) \quad (3)$$

where ℓ_1 is the unstretched length of the left spring.

(d) Since the springs are in series, the forces developed in the springs must be the same.

$$ku_1(\ell) = k[u_2(\ell) - u_2(0)] \quad (4)$$

Using eqs. (2)-(4) in eq. (1) leads to

$$u_2(z) = \frac{2x}{3\ell}z + \frac{x}{3}$$

The kinetic energy of the second spring is

Chapter 2: Modeling of SDOF Systems

$$T = \frac{1}{2} \int_0^\ell \dot{u}_2^2 \frac{m_2}{\ell} dz = \frac{\dot{x}^2 m_s}{18\ell} \int_0^\ell \left(\frac{2z}{\ell} + 1 \right)^2 dz = \frac{1}{2} \left(\frac{13}{27} m_s \right) \dot{x}^2$$

The total kinetic energy is

$$T = \frac{1}{2} \left(\frac{m_s}{3} \right) \left(\frac{\dot{x}}{3} \right)^2 + \frac{1}{2} \left(\frac{13}{27} m_s \right) \dot{x}^2 = \frac{1}{2} \left(\frac{14}{27} m_s \right) \dot{x}^2$$

Thus

$$m_{eq} = \frac{14}{27} m_s$$

Problem 2.28 illustrates the calculation of the equivalent mass of a system.

2.29 Show that the inertia effects of a torsional shaft of polar mass moment of inertia J can be approximated by adding a thin disk of moment of inertia $J/3$ at the end of the shaft.

Given: J

Find: I_{eq}

Solution: The angular displacement due to a moment M applied at the end of the shaft varies over the length of the shaft according to

$$\phi = \frac{Mx}{JG}$$

At the end of the shaft $\phi(L) = \theta = \frac{ML}{JG}$. Thus the moment at the end of the shaft is $M = \frac{\theta JG}{L}$ and

$$\phi = \frac{\theta x}{L}$$

The differential element of the shaft is $dI = \frac{J}{L} dx$ where J is the polar mass moment of inertia of the shaft. The kinetic energy is

$$T = \frac{1}{2} \int_0^L \dot{\phi}^2 dI = \frac{1}{2} \int_0^L \left(\frac{\theta \dot{x}}{L} \right)^2 \frac{J}{L} dx = \frac{1}{2} \frac{J}{3} \dot{x}^2$$

The kinetic energy of the shaft has the form $T = \frac{1}{2} I_{eq} \dot{\theta}^2$. Hence

$$I_{eq} = \frac{J}{3}$$

Problem 2.29 illustrates the equivalent moment of inertia of a shaft using a SDOF model of the shaft.

2.30 Use the static displacement of a simply supported beam to determine the mass of a particle that should be added at the midspan of the beam to approximate inertia effects in the beam.

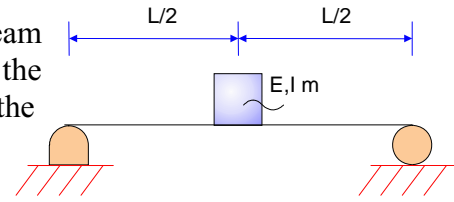

Given: $m = 20 \text{ kg}$, $m_b = 12 \text{ kg}$, $E = 200 \times 10^9 \text{ N/m}^2$,
 $I = 1.15 \times 10^{-4} \text{ m}^4$, $L = 2 \text{ m}$

Find: m_{eq}

Solution: the inertia effects of the beam are approximated by placing a particle of appropriate mass at the location of the block. The mass of the particle is determined by equating the kinetic energy of the beam to the kinetic energy of a particle placed at the location of the block. The kinetic energy of the beam is approximated using the static beam deflection equation. For a pinned-pinned beam, the deflection equation valid between the left support and the location of the block is obtained using Table D.2. In using Table D.2, set $a = L/2$. Note that Table D.2 gives results for unit loads which can be multiplied by the magnitude of the applied load to attain the deflection due to any concentrated load. Thus the deflection of a pinned-pinned beam due to a concentrated load P applied at $a = L/2$ is

$$y(z) = \frac{P}{EI} \left(-\frac{z^3}{12} + \frac{zL^2}{16} \right)$$

Let w be the deflection of the block, located at $z = L/2$. Thus

$$w = y(L/2) = \frac{PL^3}{48EI}$$

$$\frac{P}{EI} = \frac{48w}{L^3}$$

Hence

$$y(z) = \frac{wz}{L} \left(3 - 4\frac{z^2}{L^2} \right)$$

Consider a differential element of mass $dm = \rho Adz$. The kinetic energy of the differential mass is

$$dT_b = \frac{1}{2} \dot{y}^2(z) \rho Adz$$

Since the beam is symmetric about its midspan the kinetic energy of the mass to the right of the midspan is equivalent to the kinetic energy of the mass to the left of the midspan. Thus the total kinetic energy of the beam is

$$T_b = 2 \int_0^{L/2} dT_b$$

$$= \frac{1}{2} 2 \rho A \int_0^{L/2} \left(\frac{\dot{w}z}{L} \right)^2 \left(3 - 4 \frac{z^2}{L^2} \right)^2 dz$$

Evaluation of the integral yields

$$T_b = \frac{1}{2} (0.492 \rho A L) w^2 = \frac{1}{2} (0.492 m_b) w^2$$

Hence the equivalent mass is

$$m = m + 0.486 m_b$$

Problem 2.30 illustrates determination of the equivalent mass of a pinned-pinned beam.

2.31 Determine the equivalent mass or equivalent moment of inertia of the system shown in Figure P2.31 when the indicated generalized coordinate is used.

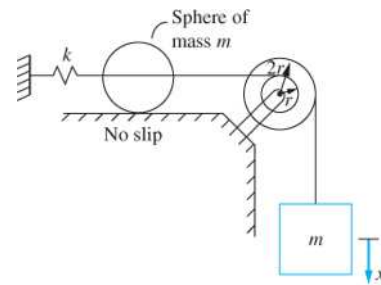

FIGURE P 2.31

Given: x , m , r

Find: m_{eq}

Solution: The kinetic energy of the system is the kinetic energy of the hanging block plus the kinetic energy of the sphere. The velocity of the mass center of the sphere is related to the velocity of the block by

$$v_s = \frac{\dot{x}}{2}$$

The total kinetic energy of the system assuming no slip between the sphere and the surface ($v_s = r_s \omega$) and knowing that the moment of inertia of a sphere is $\frac{2}{5} m r_s^2$

$$T = \frac{1}{2} m \dot{x}^2 + \frac{1}{2} m \left(\frac{\dot{x}}{2} \right)^2 + \frac{1}{2} \left(\frac{2}{5} m r_s^2 \right) \left(\frac{\dot{x}}{2 r_s} \right)^2 = \frac{1}{2} \left(\frac{27}{20} m \right) \dot{x}^2$$

The kinetic energy of the system is related to the equivalent mass by $T = \frac{1}{2} m_{eq} \dot{x}^2$. Thus

$$m_{eq} = \frac{27}{20} m$$

Problem 2.31 illustrates the equivalent mass of a system.

2.32 Determine the equivalent mass or equivalent moment of inertia of the system shown in Figure P2.32 when the indicated generalized coordinate is used.

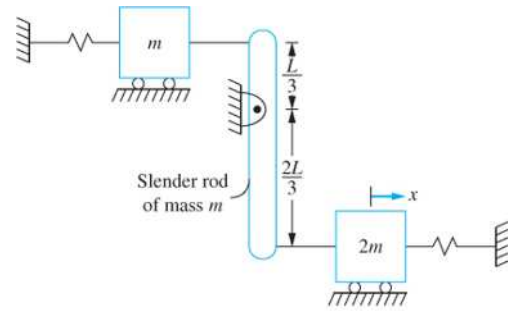

FIGURE P 2.32

Given: x, m, L

Find: m_{eq}

Solution: The total kinetic energy of the system is

$$T = \frac{1}{2}2m\dot{x}^2 + \frac{1}{2}m\dot{y}^2 + \frac{1}{2}m\dot{z}^2 + \frac{1}{2}I\dot{\theta}^2$$

where y is the displacement of the cart of mass m , z is the displacement of the mass center of the bar and θ measures the angular rotation of the bar. Kinematics is employed to obtain that if x is the displacement of the cart of mass $2m$ then assuming small θ

$$\frac{2L}{3}\theta = x$$

$$\frac{L}{3}\theta = y = \frac{x}{2}$$

$$\frac{L}{6}\theta = z = \frac{x}{4}$$

Thus the kinetic energy becomes noting that $I = \frac{1}{12}mL^2$

$$T = \frac{1}{2}2m\dot{x}^2 + \frac{1}{2}m\left(\frac{\dot{x}}{2}\right)^2 + \frac{1}{2}m\left(\frac{\dot{x}}{4}\right)^2 + \frac{1}{2}\left(\frac{1}{12}mL^2\right)\left(\frac{3\dot{x}}{2L}\right)^2 = \frac{1}{2}\left(\frac{5m}{2}\right)\dot{x}^2$$

The kinetic energy of the system is related to the equivalent mass by $T = \frac{1}{2}m_{eq}\dot{x}^2$. Thus

$$m_{eq} = \frac{5}{2}m$$

Problem 2.32 illustrates the equivalent mass of a SDOF system.

2.33 Determine the equivalent mass or equivalent moment of inertia of the system shown in Figure P2.33 when the indicated generalized coordinate is used.

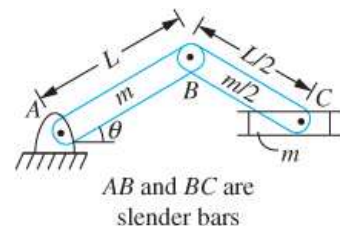

FIGURE P 2.33

Chapter 2: Modeling of SDOF Systems

Given: m, L, θ

Find: I_{eq}

Solution: The relative velocity equation is used to relate the angular velocity of bar BC and the velocity of the collar at C to the angular velocity of bar AB.

$$\mathbf{v}_B = \dot{\theta} \mathbf{k} \times L(\cos \theta \mathbf{i} + \sin \theta \mathbf{j}) = -L\dot{\theta} \sin \theta \mathbf{i} + L\dot{\theta} \cos \theta \mathbf{j}$$

$$\begin{aligned} \mathbf{v}_C &= \mathbf{v}_B + \omega_{BC} \mathbf{k} \times \frac{L}{2}(\cos \beta \mathbf{i} - \sin \beta \mathbf{j}) \\ &= \left(-L\dot{\theta} \sin \theta + \omega_{BC} \frac{L}{2} \sin \beta\right) \mathbf{i} + \left(L\dot{\theta} \cos \theta + \omega_{BC} \frac{L}{2} \cos \beta\right) \mathbf{j} \end{aligned}$$

The law of sines is used to determine that

$$\sin \beta = 2 \sin \theta$$

Then

$$\cos \beta = \sqrt{1 - 4 \sin^2 \theta}$$

Setting the j component to zero leads to

$$\omega_{BC} = \frac{2\dot{\theta} \cos \theta}{\cos \beta}$$

The x component leads to

$$v_C = -L\dot{\theta} \sin \theta + \omega_{BC} \frac{L}{2} \sin \beta = L\dot{\theta}(-\sin \theta + \cos \theta \tan \beta)$$

The relative velocity equation is used between particle B and the mass center of bar BC leading to

$$\bar{\mathbf{v}}_{BC} = \left(-L\dot{\theta} \sin \theta + \omega_{BC} \frac{L}{4} \sin \beta\right) \mathbf{i} + \left(L\dot{\theta} \cos \theta + \omega_{BC} \frac{L}{4} \cos \beta\right) \mathbf{j}$$

The kinetic energy of the system is

$$\begin{aligned} T &= \frac{1}{2} m \left(\frac{L}{2} \dot{\theta}\right)^2 + \frac{1}{2} \left(\frac{1}{12} mL^2\right) \dot{\theta}^2 \\ &\quad + \frac{1}{2} m \left[\left(-L\dot{\theta} \sin \theta + \omega_{BC} \frac{L}{4} \sin \beta\right)^2 + \left(L\dot{\theta} \cos \theta + \omega_{BC} \frac{L}{4} \cos \beta\right)^2 \right] \\ &\quad + \frac{1}{2} \left(\frac{1}{12} mL^2\right) [L\dot{\theta}(-\sin \theta + \cos \theta \tan \beta)]^2 \end{aligned}$$

The equivalent moment of inertia is calculated for a linear system by $T = \frac{1}{2} I_{eq} \dot{\theta}^2$. This system is linear only for small θ .

Problem 2.33 illustrates that the concept of equivalent mass does not work for nonlinear systems.

2.34 Determine the equivalent mass or equivalent moment of inertia of the system shown in Figure 2.34 when the indicated generalized coordinate is used.

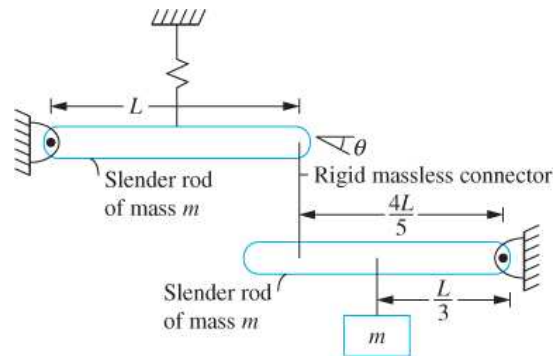

FIGURE P 2.34

Given: system shown

Find: I_{eq}

Solution: The total kinetic energy of the system is

$$T = \frac{1}{2} m \bar{v}_{AB}^2 + \frac{1}{2} \left(\frac{1}{12} mL^2 \right) \dot{\theta}^2 + \frac{1}{2} m \bar{v}_{CD}^2 + \frac{1}{2} \left(\frac{1}{12} mL^2 \right) \dot{\phi}_{CD}^2 + \frac{1}{2} m v_E^2$$

where ϕ is the angle made by the lower bar with the horizontal. The displacement of the particle on the upper bar that is connected to the rigid link is the same as the displacement of the lower bar that is connected to the link

$$L\theta = \frac{4L}{5}\phi \Rightarrow \phi = \frac{5}{4}\theta$$

Substituting into the kinetic energy leads to

$$\begin{aligned} T &= \frac{1}{2} m \left(\frac{L}{2} \dot{\theta} \right)^2 + \frac{1}{2} \left(\frac{1}{12} mL^2 \right) \dot{\theta}^2 + \frac{1}{2} m \left[\frac{L}{2} \left(\frac{5}{4} \dot{\theta} \right) \right]^2 + \frac{1}{2} \left(\frac{1}{12} mL^2 \right) \left(\frac{5}{4} \dot{\theta} \right)^2 + \frac{1}{2} m \left[\frac{L}{3} \left(\frac{5}{4} \dot{\theta} \right) \right]^2 \\ &= \frac{1}{2} \left(\frac{37}{36} mL^2 \right) \dot{\theta}^2 \end{aligned}$$

The equivalent moment of inertia when θ is used as the generalized coordinate is

$$I_{eq} = \frac{37}{36} mL^2$$

Problem 2.34 illustrates calculation of an equivalent moment of inertia.

2.35 Determine the equivalent mass or equivalent moment of inertia of the system shown in Figure P2.35 when the indicated generalized coordinate is used.

Chapter 2: Modeling of SDOF Systems

Given: shafting system with rotors

Find: J_{eq}

Given: The relation between the angular velocities of the shafts is given by the gear equation

$$\omega_2 = \frac{n_1}{n_2} \omega_1$$

$$\omega_3 = \frac{n_3}{n_4} \omega_2 = \frac{n_3 n_1}{n_4 n_2} \omega_1$$

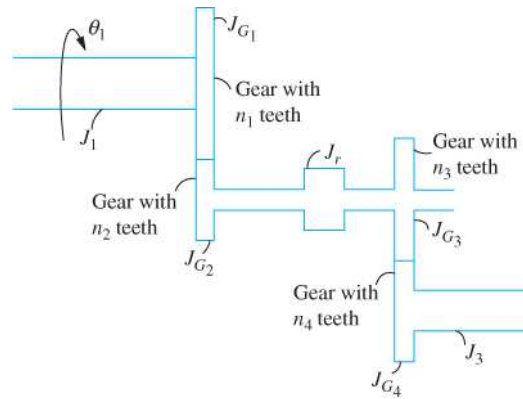

FIGURE P 2.35

The kinetic energy of the shafting system is

$$\begin{aligned} T &= \frac{1}{2} (J_1 + J_{G1}) \omega_1^2 + \frac{1}{2} (J_{G2} + J_r + J_{G3}) \left(\frac{n_1}{n_2} \omega_1 \right)^2 + \frac{1}{2} J_{G4} \left(\frac{n_3 n_1}{n_4 n_2} \omega_1 \right)^2 \\ &= \frac{1}{2} \left[(J_1 + J_{G1}) + (J_{G2} + J_r + J_{G3}) \left(\frac{n_1}{n_2} \right)^2 + J_{G4} \left(\frac{n_3 n_1}{n_4 n_2} \right)^2 \right] \omega_1^2 \end{aligned}$$

The equivalent moment of inertia is

$$J_{eq} = (J_1 + J_{G1}) + (J_{G2} + J_r + J_{G3}) \left(\frac{n_1}{n_2} \right)^2 + J_{G4} \left(\frac{n_3 n_1}{n_4 n_2} \right)^2$$

Problem 2.35 illustrates calculation of an equivalent moment of inertia of a shafting system.

2.36 Determine the kinetic energy of the system of Figure P2.36 at an arbitrary instant in terms of \dot{x} including inertia effects of the springs.

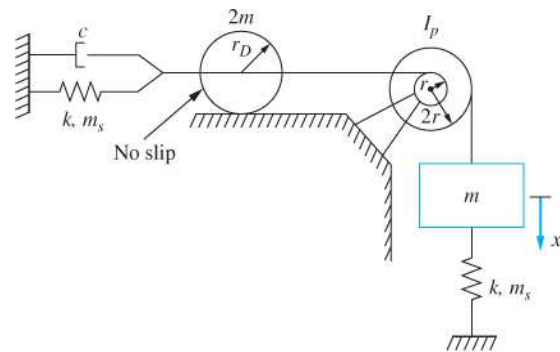

FIGURE P 2.36

Given: system shown with x as generalized coordinate

Find: T

Solution: Let θ be the clockwise angular displacement of the pulley and let x_1 be the displacement of the center of the disk, both measured from the equilibrium position of the system. Inertia effects of a spring are approximated by imagining a particle of one-third of

the mass of the spring at the location where the spring is attached to the system. The kinetic energy of the system at an arbitrary instant is

$$T = \frac{1}{2} m \dot{x}^2 + \frac{1}{2} I_p \dot{\theta}^2 + \frac{1}{2} 2m \dot{x}_1^2 + \frac{1}{2} \frac{1}{2} 2mr_D^2 \omega_D^2 + \frac{1}{2} \frac{1}{3} m_s \dot{x}^2 + \frac{1}{2} \frac{1}{3} m_s \dot{x}_1^2$$

Kinematics leads to

$$\theta = \frac{x}{2r}$$

$$x_1 = \frac{x}{2}$$

Since the disk rolls without slip

$$\omega_D = \frac{\dot{x}_1}{r_D} = \frac{\dot{x}}{2r_D}$$

Substitution into the expression for kinetic energy leads to

$$\begin{aligned} T &= \frac{1}{2} m \dot{x}^2 + \frac{1}{2} I_p \left(\frac{\dot{x}}{2r} \right)^2 + \frac{1}{2} 2m \left(\frac{\dot{x}}{2} \right)^2 + \frac{1}{2} \frac{1}{2} 2mr_D^2 \left(\frac{\dot{x}}{2r_D} \right)^2 \\ &+ \frac{1}{2} \frac{1}{3} m_s \dot{x}^2 + \frac{1}{2} \frac{1}{3} m_s \left(\frac{\dot{x}}{2} \right)^2 \\ T &= \frac{1}{2} \left(\frac{7}{4} m + \frac{I_p}{4r^2} + \frac{1}{4} m_s \right) \dot{x}^2 \end{aligned}$$

Problem 2.36 illustrates the determination of the kinetic energy of a one-degree-of-freedom system at an arbitrary instant in terms of a chosen generalized coordinate and the approximation for inertia effects of springs.

2.37 The time-dependent displacement of the block of mass m of Figure P2.36 is $x(t) = 0.03e^{-1.35t} \sin(4t)$ m. Determine the time-dependent force in the viscous damper if $c = 125$ N·s/m.

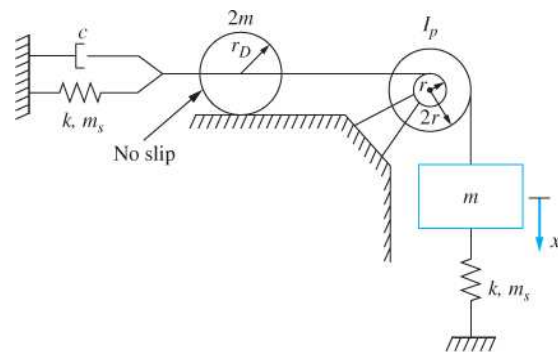

FIGURE P 2.36

Given: $x(t)$, $c = 125$ N·s/m

Find: F

Chapter 2: Modeling of SDOF Systems

Solution: The viscous damper is attached to the center of the disk. If x_1 is the displacement of the center of the disk, then kinematics leads to $x_1 = x/2$. The force developed in the viscous damper is

$$F = c\dot{x}_1 = \frac{c}{2}\dot{x}$$

$$F = \frac{c}{2}[(0.03)e^{-1.35t}(-1.35\sin(4t) + 4\cos(4t))]$$

$$F = \frac{125 \text{ N} \cdot \text{s/m}}{2}(0.03)e^{-1.35t}(-1.35\sin(4t) + 4\cos(4t))$$

$$F = 1.875e^{-1.35t}(-1.45\sin(4t) + 4\cos(4t)) \text{ N}$$

Problem 2.37 illustrates the force developed in a viscous damper.

2.38 Calculate the work done by the viscous damper of Problem 2.37 between $t = 0$ and $t = 1$ s.

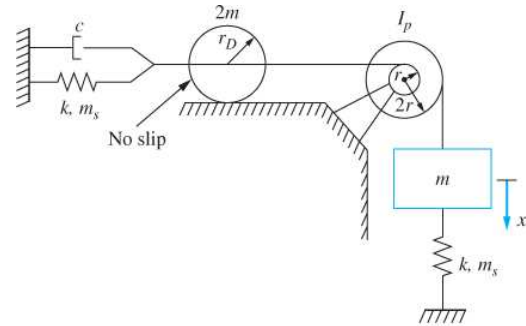

FIGURE P 2.36

Given: $x(t)$, $c=125 \text{ N}\cdot\text{s/m}$, $0 < t < 1 \text{ s}$

Find: W

$$F = 1.875e^{-1.35t}(-1.45\sin(4t) + 4\cos(4t)) \text{ N}$$

Solution: The time dependent force in the viscous damper is determined in Chapter Problem 2.37 as

The work done by the force is

$$W = -\int F(t) dx_1$$

where x_1 is the displacement of the point in the system where the viscous damper is attached. It is noted that

$$x_1(t) = \frac{1}{2}x(t) = 0.015e^{-1.35t}\sin 4t \text{ m}$$

Using the chain rule for differentials

$$dx_1 = \frac{dx_1}{dt} dt = \dot{x}_1 dt$$

It is noted that $F = c\dot{x}$. Thus

$$W = -\int c\dot{x}_1^2 dt$$

$$W = -\int_0^1 0.0281e^{-2.7t} \sin^2(4t) dt$$

$$W = -0.004211 \text{ N} \cdot \text{m}$$

Problem 2.38 illustrates the work done by a viscous damping force.

2.39 Determine the torsional viscous-damping coefficient for the torsional viscous damper of Figure P2.39. Assume a linear velocity profile between the bottom of the dish and the disk.

Given: θ, h, ρ, μ

Find: c_t

Solution: Assume the disk is rotating with an angular velocity $\dot{\theta}$. The velocity of a particle on the disk, a distance r away from the axis of rotation is

$$v = r\dot{\theta}$$

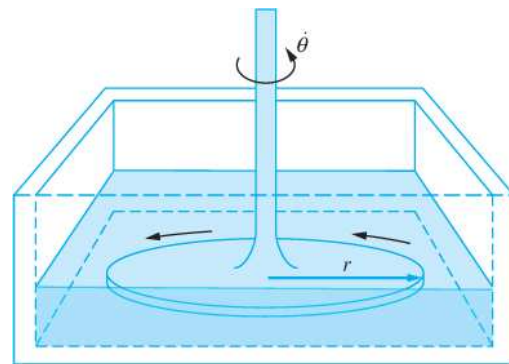

Disk of radius r
Oil of density ρ , viscosity μ
Depth of oil = h

FIGURE P 2.39

Solution: Assume the disk is rotating with an angular velocity $\dot{\theta}$. The velocity of a particle on the disk, a distance r away from the axis of rotation is

$$v = r\dot{\theta}$$

A velocity gradient exists in the fluid due to the rotation of the plate. Assume the depth of the plate is small enough such that the fluid velocity profile is linear between the bottom of the dish and the disk. The no-slip condition implies that a fluid particle adjacent to the disk, a distance r from the center of rotation has a velocity $r\dot{\theta}$ while a fluid particle adjacent to the bottom of the dish has zero velocity. Hence the velocity gradient is

$$\frac{dv}{dy} = \frac{r\dot{\theta}}{h}$$

The velocity gradient leads to a shear stress from the fluid on the dish. The shear stress is calculated using Newton's viscosity law as

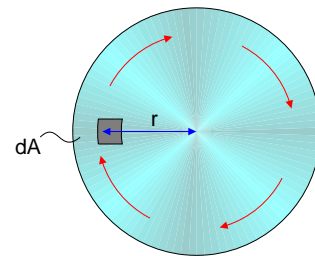

$$dm = \tau r dA$$

$$\tau = \mu \frac{dv}{dy} = \frac{\mu r \dot{\theta}}{h}$$

The resisting moment acting on the disk due to the shear stress distribution is

$$\begin{aligned} M &= \int \tau r dA = \int_0^{2\pi R} \int_0^{2\pi R} \tau r (r dr d\theta) \\ &= \int_0^{2\pi R} \int_0^{2\pi R} \frac{\mu \dot{\theta}}{h} r^3 dr d\theta \\ &= \frac{\pi \mu R^4}{2h} \dot{\theta} \end{aligned}$$

Hence the torsional damping coefficient is

$$C_t = \frac{\pi \mu R^4}{2h}$$

Problem 2.39 illustrates a type of torsional viscous damper.

2.40 Determine the torsional viscous-damping coefficient for the torsional viscous damper of Figure P2.40. Assume a linear velocity profile in the liquid between the fixed surface and the rotating cone.

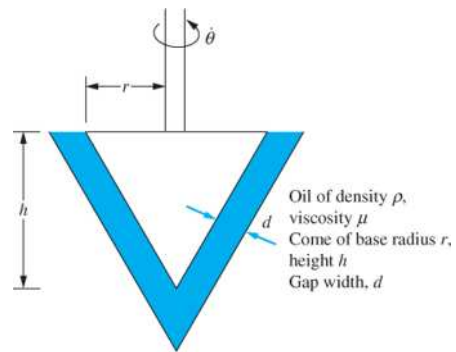

FIGURE P 2.40

Given: h, d, r, ρ, μ

Find: c_t

Solution: Let y be a coordinate measured from the tip of the cone, positive upward. Assume the cone is rotating with an angular velocity $\dot{\theta}$. The velocity of a particle on the outer surface of the cone is

$$v = R(y)\dot{\theta}$$

where $R(y)$ is the distance from the surface to the axis of the cone. From geometry

$$R(y) = \frac{ry}{h}$$

Hence,

$$v = \frac{ry\dot{\theta}}{h}$$

Assume that d is small enough such that the velocity distribution in the fluid is linear. Let z be a coordinate normal to the surface of the cone. Then using the no-slip condition between the fluid and the cone's surface and between the fluid and the fixed surface gives

$$v(z) = \frac{ry\dot{\theta}}{h} \frac{z}{d}$$

The velocity gradient produces a shear stress on the surface of the cone. Using Newton's viscosity law

$$\tau = \mu \frac{dv}{dz} = \frac{\mu ry\dot{\theta}}{hd}$$

Consider a differential slice of the cone of thickness dy . The shear stress acts around the surface of the slice, causing a resisting moment about the center of the cone of

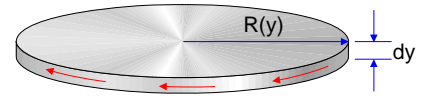

$$\begin{aligned} dM &= y(2\pi R(y))\tau dy \\ &= \frac{2\pi r^2 \mu \dot{\theta} y^3}{h^2 d} dy \end{aligned}$$

Thus the total resisting moment is

$$\begin{aligned} M &= \int dM = \frac{2\pi r^2 \mu \dot{\theta}}{h^2 d} \int_0^h y^3 dy \\ &= \frac{\pi r^2 \mu h^2}{2d} \dot{\theta} \end{aligned}$$

Hence the torsional viscous damping coefficient for this configuration is

$$c_t = \frac{\pi r^2 \mu h^2}{2d}$$

Problem 2.40 illustrates determination of the torsional viscous damping coefficient for a specific configuration.

2.41 Shock absorbers and other forms of viscous dampers use a piston moving in a cylinder of viscous liquid as illustrated in Figure P2.41. For this configuration the force developed on the piston is the sum of the viscous forces acting on the side of the piston and the force due to the pressure difference between the top and bottom surfaces of the piston.

Chapter 2: Modeling of SDOF Systems

(a) Assume the piston moves with a constant velocity v_p . Draw a free-body diagram of the piston and mathematically relate the damping force, the viscous force, and the pressure force.

(b) Assume steady flow between the side of the piston and the side of the cylinder. Show that the equation governing the velocity profile between the piston and the cylinder is

$$\frac{dp}{dx} = \mu \frac{\partial^2 v}{\partial r^2} \quad (1)$$

(c) Assume the vertical pressure gradient is constant. Use the preceding results to determine the velocity profile in terms of the damping force and the shear stress on the side of the piston.

(d) Use the results of part (c) to determine the wall shear stress in terms of the damping force.

(e) Note that the flow rate between the piston and the cylinder is equal to the rate at which the liquid is displaced by the piston. Use this information to determine the damping force in terms of the velocity and thus the damping coefficient.

(f) Use the results of part (e) to design a shock absorber for a motorcycle that uses SAE 1040 oil and requires a damping coefficient of 1000 N·m/s.

Given: v_p , d , D , h , μ , ρ , (f) SAE 1040 oil, $c = 1000$ N·m/s

Find: (a) - (e) c_{eq} , (f) design damper

Solution: (a) The free body diagram of the piston at an arbitrary instant shown below illustrates the pressure force acting on the upper top and bottom surfaces of the piston, the viscous force which is the resultant of the shear stress distribution acting around the circumference of the piston, and the reaction force in the piston rod.

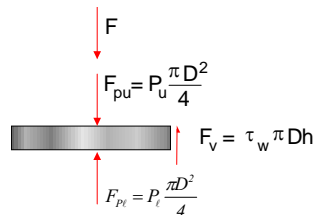

Assuming the inertia force of the piston is small, summation of forces acting on the piston leads to

$$F = F_{pl} - F_{pu} + F_v$$

where

$$F_{p\ell} - F_{pu} = (p_\ell - p_u)\pi \frac{D^2}{4}$$

$$F_v = \tau_w \pi Dh$$

Hence

$$F = (p_\ell - p_u)\pi \frac{D^2}{4} + \tau_w \pi Dh$$

(b) Consider a differential ring of height dx and thickness dr , a distance r from the center of the position. Consider a free body diagram of the element

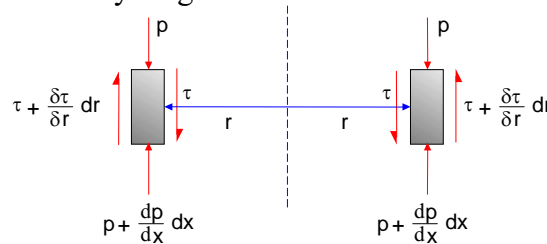

Summation of forces acting of the element leads to

$$\left(p + \frac{dp}{dx} dx - p \right) (2\pi r dr) + \left(\tau + \frac{\partial \tau}{\partial r} dr - \tau \right) (2\pi r dx) = 0$$

$$\frac{dp}{dx} = - \frac{\partial \tau}{\partial r}$$

If the fluid is Newtonian

$$\tau = - \mu \frac{\partial v}{\partial r}$$

where $v(r, x)$ is the velocity distribution in the fluid. Thus

$$\frac{dp}{dx} = \mu \frac{\partial^2 v}{\partial r^2}$$

(c) Assume $dp/dx = C$, a constant. Then from the preceding equation

$$v = \frac{C}{2\mu} r^2 + c_1 r + c_2$$

where c_1 and c_2 are constants of integration. The boundary conditions are

$$v(R = D/2) = v$$

$$v(R = d) = 0$$

Application of the boundary conditions leads to

Chapter 2: Modeling of SDOF Systems

$$c_1 = -\frac{v}{d} + \frac{C}{2\mu}(2R + d)$$

$$c_2 = v\left(1 + \frac{R}{d}\right) + \frac{C}{2\mu}(R^2 + Rd)$$

Using Newton's viscosity law

$$\tau_w = -\mu \frac{dv}{dr}(r = R) = \mu \frac{v}{d} + C \frac{d}{2}$$

$$C = \frac{2}{d} \left(\tau_w - \mu \frac{v}{d} \right)$$

Note that since the pressure is constant

$$\frac{dp}{dx} = \frac{p_\ell - p_u}{h}$$

Hence the damping force becomes

$$F = \tau_w \pi D h \left(1 + \frac{D}{2d} \right) - \frac{\mu v \pi D^2 h}{2d^2}$$

(d) Note that the flow rate must be equal to the velocity of the piston times the area of the piston

$$Q = \pi \frac{D^2}{4} v$$

The flow rate is also calculated by

$$Q = \int_R^{R+d} v(r) 2\pi r dr$$

$$= 2\pi \left[\frac{1}{\mu d} \left(\tau_w - \mu \frac{v}{d} \right) \left(-\frac{1}{6} R d^3 + \frac{2}{3} d^4 \right) + \frac{1}{6} v d^2 \right]$$

Equating Q from the previous two equations and solving for the wall shear stress leads to

$$\tau_w = \frac{\mu v (3D^2 - 2dD - 12d^2)}{2d^2(D - 8d)}$$

and leads to

$$F = \frac{\mu D \pi h (3D^3 - dD^2 - 24d^3)}{4d^3(D - 8d)} v$$

which leads to the damping coefficient

$$c = \frac{\mu\pi Dh(3D^3 - D^2d - 24d^3)}{4d^3(D - 8d)}$$

If $D \gg d$, the preceding equation is approximated by

$$c = \frac{3\pi\mu h D^3}{4d^3}$$

Corrections to the above equation in powers of d/D can be obtained by expanding the reciprocal of the denominator in powers of d/D using a binomial expansion, multiplying by the numerator, simplifying and collecting coefficients on like powers of d/D .

(e) The viscosity of SAE 1040 oil is approximately $0.4 \text{ N}\cdot\text{s} / \text{m}^2$

Assume $h = 0.5 \text{ mm}$ and $d = 10 \text{ mm}$. Then setting $c = 1000 \text{ N}\cdot\text{s}/\text{m}$ and assuming $D \gg d$ leads to

$$1000 = \frac{0.4\pi(0.0005)(3D^3)}{4(0.01)^3}$$

$$D = 0.374 \text{ m}$$

Problem 2.41 illustrates (a) the derivation of the viscous damping coefficient for a piston-cylinder dashpot, and (b) the use of the equation for the viscous damping coefficient to design a viscous damper for a given situation.

2.42 Derive the differential equation governing the motion of the one degree-of-freedom system by applying the appropriate form(s) of Newton's laws to the appropriate free-body diagrams. Use the generalized coordinates shown in Figure P2.42. Linearize nonlinear differential equations by assuming small displacements.

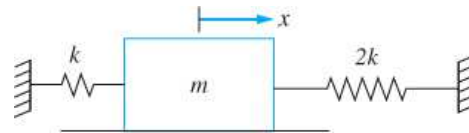

FIGURE P 2.42

Given: x as generalized coordinate, m , k

Find: differential equation

Solution: Free-body diagrams of the system at an arbitrary time are shown below.

Chapter 2: Modeling of SDOF Systems

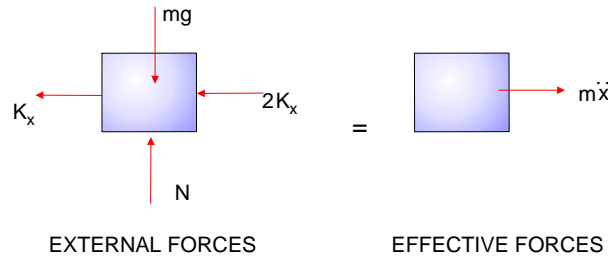

Summing forces acting on the block

$$\left(\sum F\right)_{ext} = \left(\sum F\right)_{eff}$$

gives

$$\begin{aligned} -kx - 2kx &= m\ddot{x} \\ m\ddot{x} + 3kx &= 0 \\ \ddot{x} + \frac{3k}{m}x &= 0 \end{aligned}$$

Problem 2.42 illustrates application of Newton's law to derive the differential equation governing free vibration of a one-degree-of-freedom system.

2.43 Derive the differential equation governing the motion of the one degree-of-freedom system by applying the appropriate form(s) of Newton's laws to the appropriate free-body diagrams. Use the generalized coordinates shown in Figure P2.43. Linearize nonlinear differential equations by assuming small displacements.

Given: x as generalized coordinate, k , m , I , r

Find: differential equation

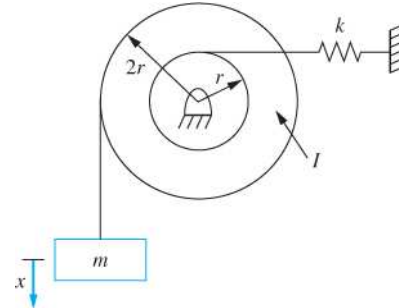
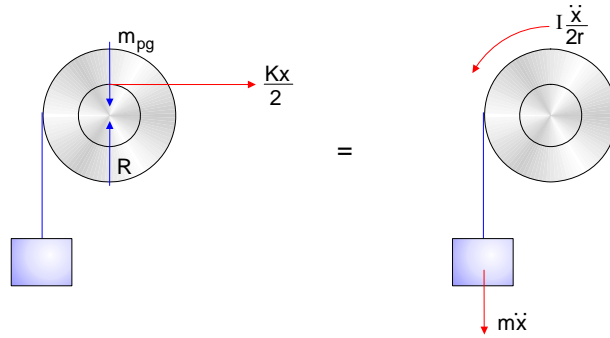

FIGURE P 2.43

Solution: Since x is measured from the system's equilibrium position, gravity cancels with the static spring forces in the governing differential equation. Thus, for purposes of deriving the differential equation, both are ignored. It is assumed there is no slip between the cable and the pulley. Thus the angular rotation of the pulley is kinematically related to the displacement of the block by

$$\theta = \frac{x}{2r}$$

Free-body diagrams of the system are shown below at an arbitrary instant.



Summing moments about the center of the pulley

$$\left(\sum M_c\right)_{ext} = \left(\sum M_c\right)_{eff}$$

leads to

$$-\frac{1}{2}kx(r) = m\ddot{x}(2r) + \frac{I}{2r}\ddot{x}$$

$$\left(2rm + \frac{I}{2r}\right)\ddot{x} + \frac{1}{2}krx = 0$$

$$\ddot{x} + \frac{k}{2\left(2m + \frac{I}{2r^2}\right)}x = 0$$

Problem 2.43 illustrates application of Newton’s law to derive the differential equation governing free vibration of a one-degree-of- freedom system. This problem also illustrates the benefits of using external and effective forces. Use of this method allows one free-body diagram to be drawn showing all effective forces. If this method were not used, one free-body diagram for the block and one free-body diagram of the pulley must be drawn. These free-body diagrams expose the tension in the pulley cable. Application of Newton’s laws to the free-body diagrams yield equations involving the unknown tension. The tension must be eliminated between the equations in order to derive the differential equation.

2.44 Derive the differential equation governing the motion of the one degree-of-freedom system by applying the appropriate form(s) of Newton’s laws to the appropriate free-body diagrams. Use the generalized coordinates shown in Figure P2.44. Linearize nonlinear differential equations by assuming small displacements.

Given: k, L, m, c

Find: differential equation

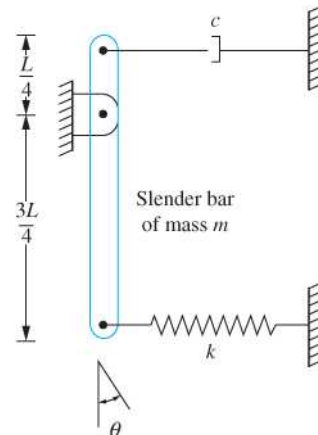
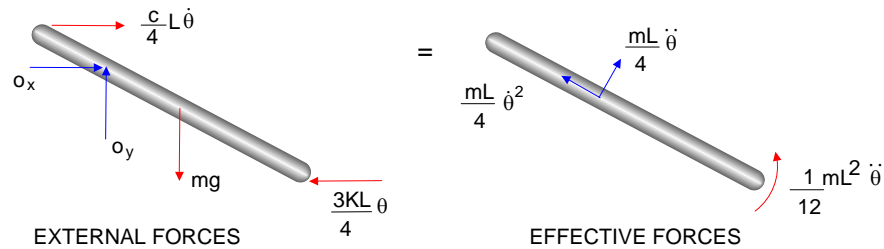

FIGURE P 2.44

Chapter 2: Modeling of SDOF Systems

Solution: The small angle assumption is used. Free-body diagrams of the bar at an arbitrary instant are shown below.



Summing moments about the point of support

$$\left(\sum M_o\right)_{ext} = \left(\sum M_o\right)_{eff}$$

leads to

$$\begin{aligned} -\frac{1}{4}Lc\dot{\theta}\left(\frac{1}{4}L\right) - \frac{3}{4}LK\theta\left(\frac{3}{4}L\right) - mg\frac{L}{4}\theta &= \frac{1}{4}mL\ddot{\theta}\left(\frac{1}{4}L\right) + \frac{1}{12}mL^2\ddot{\theta} \\ \frac{7}{48}mL^2\ddot{\theta} + \frac{1}{16}cL^2\dot{\theta} + \left(\frac{9}{16}kL^2 + mg\frac{L}{4}\right)\theta &= 0 \\ \ddot{\theta} + \frac{3}{7}\frac{c}{m}\dot{\theta} + \left(\frac{27}{7}\frac{k}{m} + \frac{12}{7}\frac{g}{L}\right)\theta &= 0 \end{aligned}$$

Problem 2.44 illustrates application of Newton's law to derive the differential equation governing the free vibrations of a one-degree-of-freedom linear system with viscous damping.

2.45 Derive the differential equation governing the motion of the one degree-of-freedom system by applying the appropriate form(s) of Newton's laws to the appropriate free-body diagrams. Use the generalized coordinates shown in Figure P2.45. Linearize nonlinear differential equations by assuming small displacements.

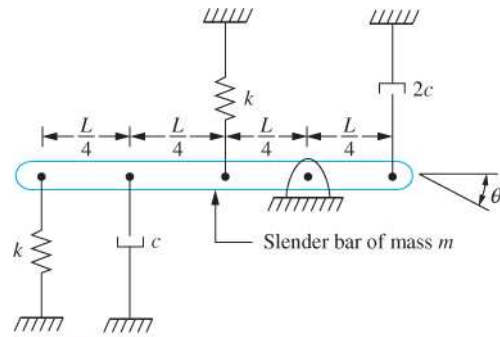
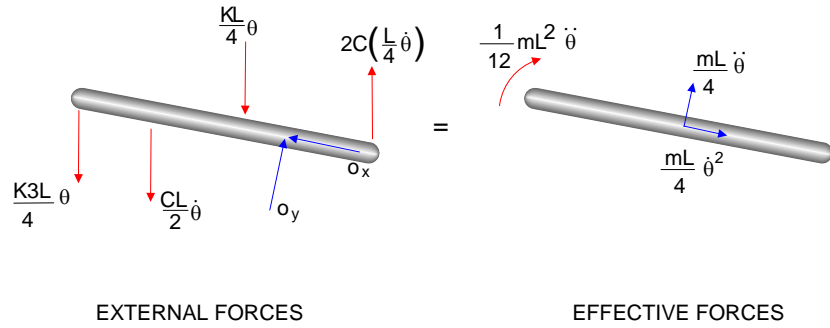

FIGURE P 2.45

Given: m , c , k , L , θ as generalized coordinate

Find: differential equation

Solution: The small angle assumption is used. It is also noted that gravity, which causes static spring forces, causes with these static spring forces in the governing differential equation and hence both are ignored. Free-body diagrams of the bar at an arbitrary instant are shown below.



Summing moments about the point of support,

$$\left(\sum M_o\right)_{ext} = \left(\sum M_o\right)_{eff}$$

leads to

$$-\frac{3}{4}kL\theta\left(\frac{3}{4}L\right) - \frac{L}{2}c\dot{\theta}\left(\frac{L}{2}\right) - \frac{L}{4}k\theta\left(\frac{L}{4}\right) - \frac{L}{2}c\dot{\theta}\left(\frac{L}{4}\right) = \frac{L}{4}m\ddot{\theta}\left(\frac{L}{4}\right) + \frac{1}{12}mL^2\ddot{\theta}$$

$$\frac{7}{48}mL^2\ddot{\theta} + \frac{3}{8}cL^2\dot{\theta} + \frac{5}{8}kL^2\theta = 0$$

$$\ddot{\theta} + \frac{18}{7}\frac{c}{m}\dot{\theta} + \frac{30}{7}\frac{k}{m}\theta = 0$$

Problem 2.45 illustrates application of Newton’s law to derive the differential equation governing the free vibration of a one-degree-of-freedom system with viscous damping.

2.46 Derive the differential equation governing the motion of the one degree-of-freedom system by applying the appropriate form(s) of Newton’s laws to the appropriate free-body diagrams. Use the generalized coordinates shown in Figure P2.46. Linearize nonlinear differential equations by assuming small displacements.

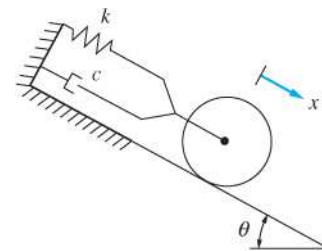

Thin disk of mass m
radius r rolls
without slip

FIGURE P 2.46

Given: m, k, c, x as generalized coordinate

Find: differential equation, ω_n

Solution: The effect of the incline is to cause a non-zero static deflection in the spring. Thus, neither the gravity force or the static spring force have any effect on the differential equation and both are ignored in drawing the free body diagrams. Assuming the disk rolls without slip, its angular acceleration is related to the acceleration of the mass center by

$$\alpha = \frac{\dot{x}}{r}$$

Chapter 2: Modeling of SDOF Systems

Consider the free body diagrams drawn below at an arbitrary instant

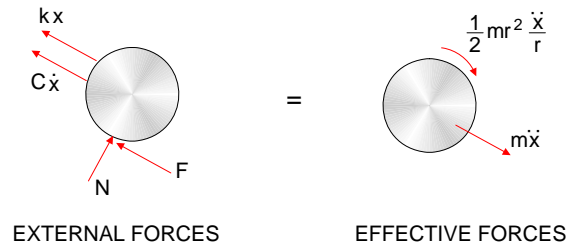

Summing moments about the point of contact between the disk and the incline

$$\left(\sum M_c\right)_{ext} = \left(\sum M_c\right)_{eff}$$

leads to

$$-kxr - c\dot{x}r = \frac{1}{2}mr^2 \frac{\ddot{x}}{r} + m\ddot{x}r$$

$$\frac{3}{2}m\ddot{x} + c\dot{x} + kx = 0$$

$$\ddot{x} + \frac{2c}{3m}\dot{x} + \frac{2k}{3m}x = 0$$

Problem 2.46 illustrates application of Newton's law to determine the governing differential equation for free vibrations of a one-degree-of-freedom system with viscous damping.

2.47 Derive the differential equation governing the motion of one-degree-of-freedom system by applying the appropriate form(s) of Newton's laws to the appropriate free-body diagrams. Use the generalized coordinate shown in Figure P.2.47. Linearize nonlinear differential equations by assuming small displacements.

Given: system shown

Find: differential equation

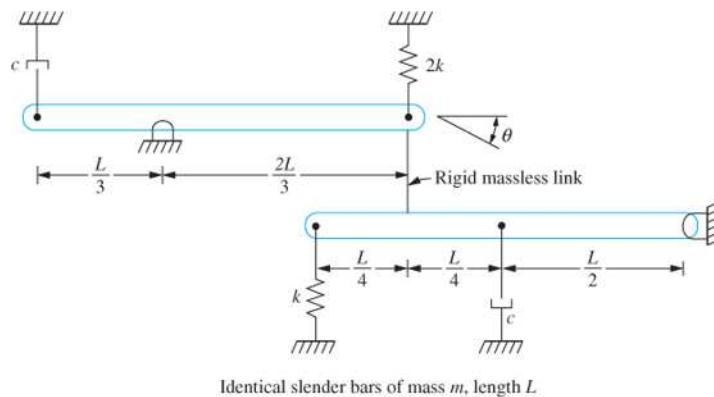
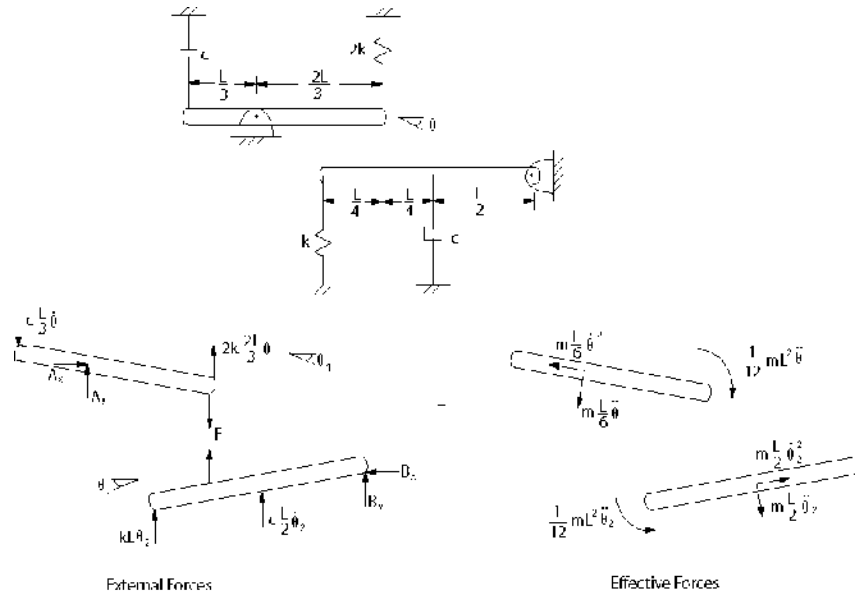

FIGURE P 2.47

Solution: Free-body diagrams of the system at an arbitrary instant are shown below.



The displacement of each end of the rigid rod is the same. Using the small angle assumption

$$\frac{2L}{3}\theta = \frac{3L}{4}\theta_2$$

$$\theta_2 = \frac{8}{9}\theta$$

Summing moments about the pin support of the upper bar leads to

$$\left(\sum M_A\right)_{ext} = \left(\sum M_A\right)_{eff}$$

$$-c\left(\frac{L}{3}\dot{\theta}\right)\frac{L}{3} - 2k\left(\frac{2L}{3}\theta\right)\frac{2L}{3} + F\frac{2L}{3} = \frac{1}{12}mL^2\ddot{\theta} + m\frac{L}{6}\ddot{\theta}\frac{L}{6}$$

$$F = \frac{mL}{6}\ddot{\theta} + \frac{cL}{6}\dot{\theta} + \frac{4kL}{3}\theta$$

Summing moments about the pin support of the lower bar leads to

$$\left(\sum M_B\right)_{ext} = \left(\sum M_B\right)_{eff}$$

$$-kL\theta_2L - c\left(\frac{L}{2}\dot{\theta}_2\right)\frac{L}{2} - F\frac{3L}{4} = \frac{1}{12}mL^2\ddot{\theta}_2 + m\left(\frac{L}{2}\ddot{\theta}_2\right)\frac{L}{2}$$

Substitution for F and θ_2 leads to

$$\frac{91}{216} mL^2 \ddot{\theta} + \frac{25}{72} cL^2 \dot{\theta} + \frac{17}{9} kL^2 \theta = 0$$

Rewriting the equation in standard form

$$\ddot{\theta} + \frac{75c}{91m} \dot{\theta} + \frac{408k}{91m} \theta = 0$$

Problem 2.47 illustrates the derivation of the differential equation governing the motion of a linear one-degree-of-freedom system using the free-body diagram method.

2.48 Derive the differential equation governing the motion of one-degree-of-freedom system by applying the appropriate form(s) of Newton's laws to the appropriate free-body diagrams. Use the generalized coordinate shown in Figure P2.48. Linearize nonlinear differential equations by assuming small displacements.

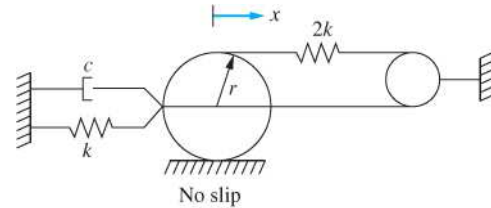

Thin disk of mass m , radius r

FIGURE P 2.48

Given: system shown

Find: differential equation

Solution: Free-body diagrams of the system at an arbitrary instant are shown below

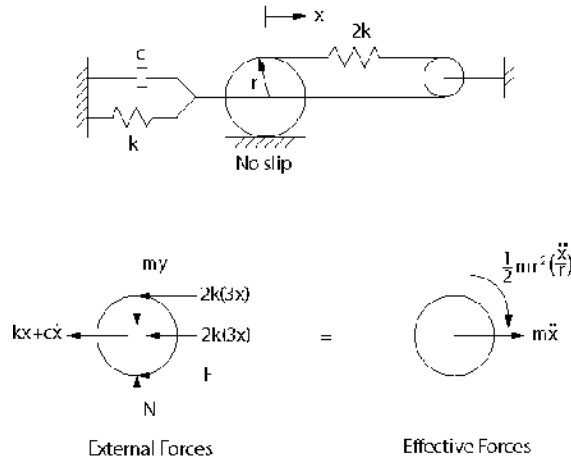

Note that the force developed in the spring is proportional to the change in length of the spring. When the center of the disk is displaced a distance x from equilibrium, the end of the spring attached to the center of the disk compresses by x . When the center of the disk displaces x , the point on the disk to which the spring is attached has translated a distance x and rotated along the distance an angle θ . Assuming no slip between the disk and the

surface, $\theta = x/r$. Hence this end of the spring has displaced $2x$. The total change in length of this spring is $3x$.

Summing moments about the point of contact between the disk and surface leads to

$$\begin{aligned} \left(\sum M_C\right)_{ext} &= \left(\sum M_C\right)_{eff} \\ -(kx + c\dot{x})r - 2k(3x)r - 2k(3x)(2r) &= m\ddot{x}(r) + \frac{1}{2}mr^2 \frac{\ddot{x}}{r} \\ \frac{3}{2}mr\ddot{x} + cr\dot{x} + 19krx &= 0 \end{aligned}$$

The differential equation is put into standard form by dividing by the coefficient of \ddot{x} leading to

$$\ddot{x} + \frac{2c}{3m}\dot{x} + \frac{38k}{3m}x = 0$$

Problem 2.48 illustrates derivation of the differential equation governing the motion of a one-degree-of-freedom system using the free-body diagram method, putting the differential equation into a standard form, and determination of the natural frequency from the differential equation.

2.49 Derive the differential equation governing the motion of the one-degree-of-freedom system by applying the appropriate form(s) of Newton's laws to the appropriate free-body diagrams. Use the generalized coordinate shown in Figure P2.49. Linearize nonlinear differential equations by assuming small displacements.

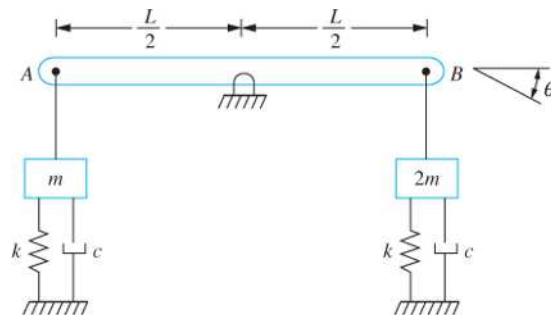

Slender bar of mass m connected to blocks through rigid links at A and B

FIGURE P 2.49

Given: system shown

Find: differential equation

Solution: Free-body diagrams of the system at an arbitrary instant are shown below

Chapter 2: Modeling of SDOF Systems

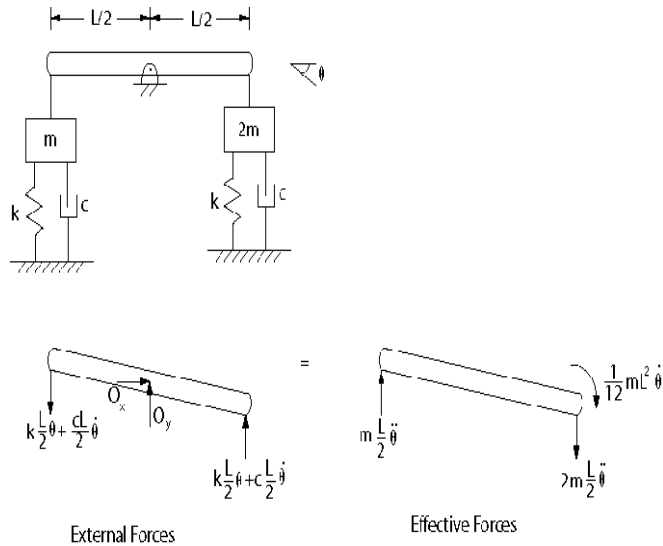

Summing moments about the pin support leads to

$$\begin{aligned} \left(\sum M_o\right)_{ext} &= \left(\sum M_o\right)_{eff} \\ -\left(k\frac{L}{2}\theta + c\frac{L}{2}\dot{\theta}\right)\frac{L}{2} - \left(k\frac{L}{2}\theta + c\frac{L}{2}\dot{\theta}\right)\frac{L}{2} &= \frac{1}{12}mL^2\ddot{\theta} + m\frac{L}{2}\ddot{\theta}\frac{L}{2} + 2m\frac{L}{2}\ddot{\theta}\frac{L}{2} \\ \frac{5}{6}mL^2\ddot{\theta} + \frac{1}{2}cL^2\dot{\theta} + \frac{1}{2}kL^2\theta &= 0 \end{aligned}$$

The differential equation is put into standard form by dividing by the coefficient of $\ddot{\theta}$ leading to

$$\ddot{\theta} + \frac{3c}{5m}\dot{\theta} + \frac{3k}{5m}\theta = 0$$

Problem 2.49 illustrates the use of the free-body diagram method to derive the differential equation governing the motion of a one-degree-of-freedom system.

2.50 Derive the differential equation governing the motion of the one degree-of-freedom system by applying the appropriate form(s) of Newton's laws to the appropriate free-body diagrams. Use the generalized coordinates shown in Figure P2.50. Linearize nonlinear differential equations by assuming small displacements.

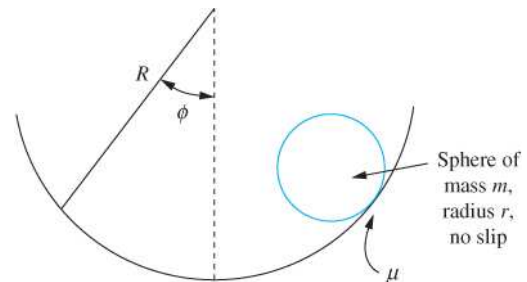

FIGURE P 2.50

Given: R, r, m, ϕ as generalized coordinate

Find: differential equation, ω_n

Solution: The generalized coordinate is chosen as ϕ , the angle made between the normal to the sphere and the surface at any instant of time. Let θ be an angular coordinate representing the angular displacement of the sphere. If the sphere rolls without slip, then the distance traveled by the mass center of the sphere is

$$x = r\theta \tag{1}$$

However, the mass center of the sphere is also traveling in a circular path of radius $(R-r)$. Thus the distance traveled by the mass center is also equal to

$$x = (R - r)\phi \tag{2}$$

Equating x from eqs.(1) and (2) leads to

$$\theta = \frac{R-r}{r}\phi$$

Now consider free body diagrams of the sphere at an arbitrary instant.

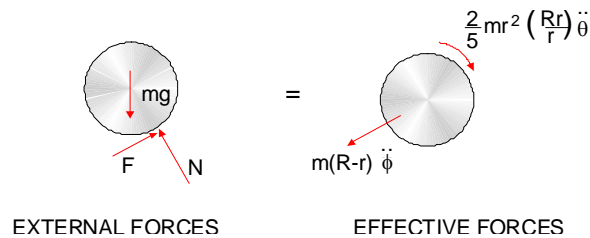

Summing moments about the point of contact,

$$\left(\sum M_c\right)_{ext} = \left(\sum M_c\right)_{eff}$$

leads to

$$-mgr \sin \phi = \frac{2}{5}mr^2 \left(\frac{R-r}{r}\right)\ddot{\phi} + m(R-r)\ddot{\phi}$$

$$\frac{7}{5}(R-r)\ddot{\phi} + g \sin \phi = 0$$

Assuming small ϕ

$$\frac{7}{5}(R-r)\ddot{\phi} + g\phi = 0$$

$$\ddot{\phi} + \frac{5g}{7(R-r)}\phi = 0$$

Problem 2.50 illustrates application of Newton's law to derive the differential equation governing free vibration of a one-degree-of-freedom system.

2.51 Derive the differential equation governing the motion of the one-degree-of-freedom system by applying the appropriate form(s) of Newton's laws to the appropriate free-body diagrams. Use the generalized coordinate shown in Figure P2.51. Linearize nonlinear differential equations by assuming small displacements.

Given: system shown

Find: differential equation

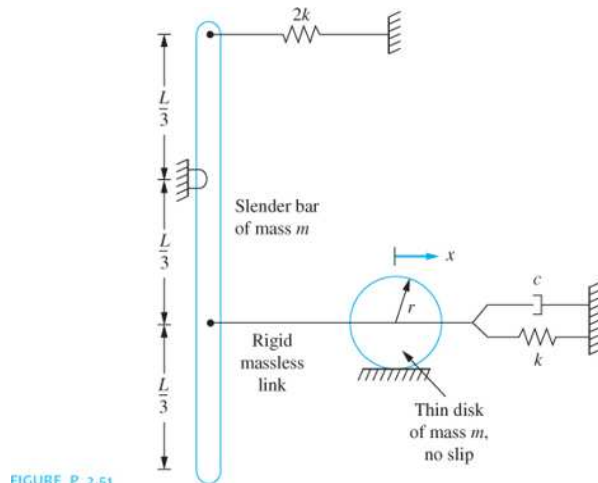

Solution: Free-body diagrams of the system at an arbitrary instant are shown below

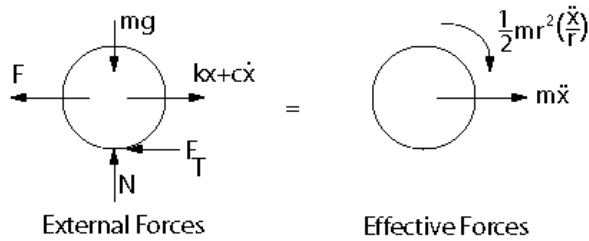
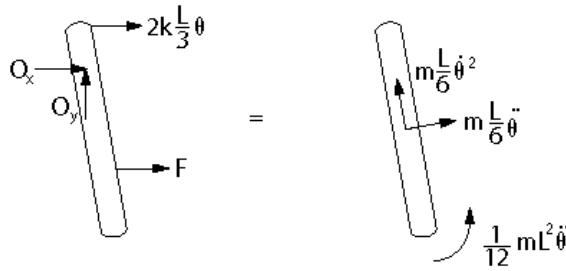
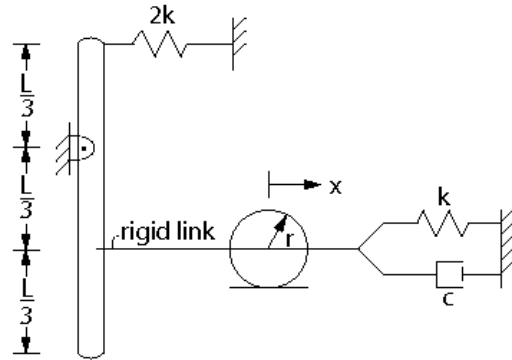

Summing moments about the point of support of the bar using the small angle assumption leads to

$$\begin{aligned}
 \left(\sum M_o\right)_{ext} &= \left(\sum M_o\right)_{eff} \\
 -mg \frac{L}{6} \theta - 2k \frac{L}{3} \theta \frac{L}{3} + F \frac{L}{3} &= \frac{1}{12} mL^2 \ddot{\theta} + m \frac{L}{6} \ddot{\theta} \frac{L}{6} \\
 F &= \frac{1}{3} mL \ddot{\theta} + \left(2k \frac{L}{3} + \frac{1}{2} mg\right) \theta
 \end{aligned}$$

Summing moments about the point of contact between the disk and the surface leads to

Chapter 2: Modeling of SDOF Systems

$$\begin{aligned} \left(\sum M_c\right)_{ext} &= \left(\sum M_c\right)_{eff} \\ -Fr - kxr - c\dot{x}r &= m\ddot{x}r + \frac{1}{2}mr^2\left(\frac{\ddot{x}}{r}\right) \\ F &= -\frac{3}{2}m\ddot{x} - c\dot{x} - kx \end{aligned}$$

Kinematics is used to give

$$x = \frac{L}{3}\theta \quad \theta = \frac{3x}{L}$$

Equating the two expressions for F and substituting for θ leads to

$$\begin{aligned} -\frac{3}{2}m\ddot{x} - c\dot{x} - kx &= \frac{1}{3}mL\left(\frac{3\ddot{x}}{L}\right) + \left(2k\frac{L}{3} + \frac{1}{2}mg\right)\left(\frac{3x}{L}\right) \\ \frac{5}{2}m\ddot{x} + c\dot{x} + \left(3k + \frac{3mg}{2L}\right)x &= 0 \end{aligned}$$

The differential equation is put into standard form by dividing by the coefficient of \ddot{x} leading to

$$\ddot{x} + \frac{2c}{5m}\dot{x} + \left(\frac{6k}{5m} + \frac{3g}{5L}\right)x = 0$$

Problem 2.51 illustrates the application of the free-body diagram method to derive the differential equation governing the motion of a one-degree-of-freedom system.

2.52 Determine the differential equations governing the motion of the system by using the equivalent systems method. Use the generalized coordinates shown in Figure P2.52.

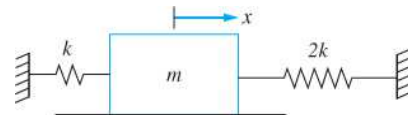

FIGURE P 2.52

Given: system shown

Find: differential equation using x as the generalized coordinate.

Solution: The springs attached to the mass act as two springs in parallel. The system can be modeled by a mass attached to a spring of equivalent stiffness $3k$. Thus the governing differential equation is

$$m\ddot{x} + 3kx = 0$$

or

$$\ddot{x} + 3 \frac{k}{m} x = 0$$

Problem 2.52 illustrates the application of the equivalent system approach to derive the governing differential equation for a block attached to springs in parallel.

2.53 Determine the differential equations governing the motion of the system by using the equivalent systems method. Use the generalized coordinates shown in Figure P2.53.

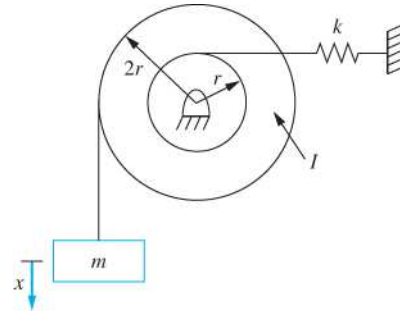

FIGURE P 2.53

Given: x as generalized coordinate, k , m , I , r

Find: differential equation

Solution: Since x is measured from the system's equilibrium position, gravity cancels with the static spring forces in the governing differential equation. Thus, for purposes of deriving the differential equation, both are ignored. It is assumed there is no slip between the cable and the pulley. Thus the angular rotation of the pulley is kinematically related to the displacement of the block by

$$\theta = \frac{x}{2r}$$

The equivalent systems method is used. The system is modeled by a mass-spring system of an equivalent mass and equivalent stiffness, using the generalized coordinate, x . The kinetic energy of the equivalent system at an arbitrary time is

$$T = \frac{1}{2} m_{eq} \dot{x}^2$$

The kinetic energy of the system at an arbitrary instant is

$$\begin{aligned} T &= \frac{1}{2} m \dot{x}^2 + \frac{1}{2} I \left(\frac{\dot{x}}{2r} \right)^2 \\ &= \frac{1}{2} \left(m + \frac{I}{4r^2} \right) \dot{x}^2 \end{aligned}$$

Requiring the kinetic energy of the equivalent system to be equal to the kinetic energy of the original system at any instant leads to

Chapter 2: Modeling of SDOF Systems

$$m_{eq} = m + \frac{I}{4r^2}$$

The potential energy of the equivalent system at an arbitrary instant is

$$V = \frac{1}{2} k_{eq} x^2$$

The potential energy of the system at hand at an arbitrary instant is

$$v = \frac{1}{2} k \left(\frac{x}{2} \right)^2$$

$$v = \frac{1}{2} \frac{k}{4} x^2$$

Requiring the potential energies to be equal at any instant leads to

$$k_{eq} = \frac{k}{4}$$

The differential equation governing free vibration is

$$m_{eq} \ddot{x} + k_{eq} x = 0$$

$$\left(m + \frac{I}{4r^2} \right) \ddot{x} + \frac{k}{4} x = 0$$

$$\ddot{x} + \frac{k}{4 \left(m + \frac{I}{4r^2} \right)} x = 0$$

Problem 2.53 illustrates use of the equivalent system method to derive the differential equation governing free vibration of a one-degree-of-freedom system.

2.54 Determine the differential equations governing the motion of the system by using the equivalent systems method. Use the generalized coordinates shown in Figure P2.54.

Given: k, m, c, θ as generalized coordinate

Find: differential equation, ω_n

Solution: The small angle assumption is used. Since the generalized coordinate is an angular displacement the

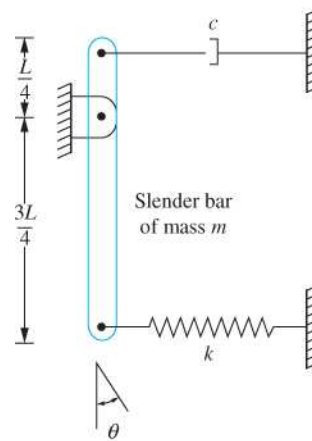

FIGURE P 2.54

system is modeled by a disk of mass moment of inertia I_{eq} attached to a shaft of torsional stiffness $k_{t,eq}$ and connected to a torsional viscous damper of torsional damping coefficient $c_{t,eq}$.

The kinetic energy of the system at an arbitrary time is

$$\begin{aligned} T &= \frac{1}{2} m \bar{v}^2 + \frac{1}{2} I \omega^2 \\ &= \frac{1}{2} m \left(\frac{L}{6} \dot{\theta} \right)^2 + \frac{1}{2} \frac{1}{12} mL^2 \dot{\theta}^2 \\ &= \frac{1}{2} \frac{7}{48} mL^2 \dot{\theta}^2 \end{aligned}$$

Hence,

$$I_{eq} = \frac{7}{48} mL^2$$

Using a horizontal plane through the pin support as the datum for potential energy calculations due to gravity, the potential energy of the system at an arbitrary time is

$$\begin{aligned} V &= \frac{1}{2} k \left(\frac{3}{4} L \theta \right)^2 - mg \frac{L}{4} \cos \theta \\ &= \frac{1}{2} \frac{9}{16} kL^2 \theta^2 - mg \frac{L}{4} \cos \theta \end{aligned}$$

Using the small angle assumption and the Taylor series expansion for $\cos \theta$, truncated after the quadratic term, leads to

$$\begin{aligned} V &= \frac{1}{2} \frac{9}{16} kL^2 \theta^2 - mg \frac{L}{4} \left(1 - \frac{1}{2} \theta^2 \right) \\ &= mg \frac{L}{2} + \frac{1}{2} \left(\frac{9}{16} kL^2 + mg \frac{L}{4} \right) \theta^2 \end{aligned}$$

Hence

$$k_{t,eq} = \frac{9}{16} kL^2 + mg \frac{L}{4}$$

The work done by the damping force between two arbitrary times is

$$W = - \int c \left(\frac{L}{4} \dot{\theta} \right) d \left(\frac{L}{4} \theta \right)$$

$$= - \int \frac{1}{16} c L^2 \dot{\theta} d\theta$$

Hence

$$c_{t_{eq}} = \frac{1}{16} c L^2$$

The governing differential equation is

$$I_{eq} \ddot{\theta} + c_{t_{eq}} \dot{\theta} + k_{t_{eq}} \theta = 0$$

$$\frac{7}{48} m L^2 \ddot{\theta} + \frac{1}{16} c L^2 \dot{\theta} + \left(\frac{9}{16} k L^2 + m g \frac{L}{4} \right) \theta = 0$$

$$\ddot{\theta} + \frac{3}{7} \frac{c}{m} \dot{\theta} + \left(\frac{27}{7} \frac{k}{m} + \frac{12}{7} \frac{g}{L} \right) \theta = 0$$

Problem 2.54 illustrates application of the equivalent systems method to derive the differential equation governing the motion of a one-degree-of-freedom system with viscous damping.

2.55 Determine the differential equations governing the motion of the system by using the equivalent systems method. Use the generalized coordinates shown in Figure P2.55.

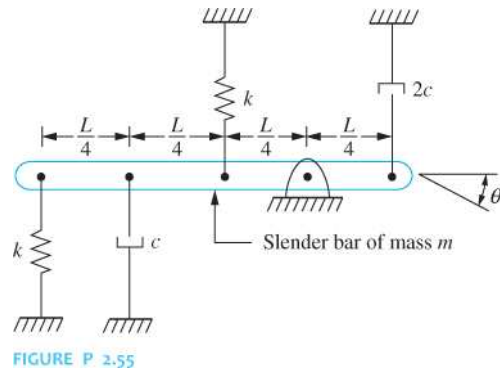

Given: system shown

Find: differential equation using θ as the generalized coordinate

Solution: The small angle assumption is used. Since the generalized coordinate is an angular coordinate, the appropriate equivalent system model is a thin disk of mass moment-of inertia I_{eq} , attached to a shaft of torsional stiffness $k_{t,eq}$, and torsional viscous damper of damping coefficient $c_{t,eq}$. The kinetic energy of the equivalent system is

$$T = \frac{1}{2} I_{eq} \dot{\theta}^2 \tag{1}$$

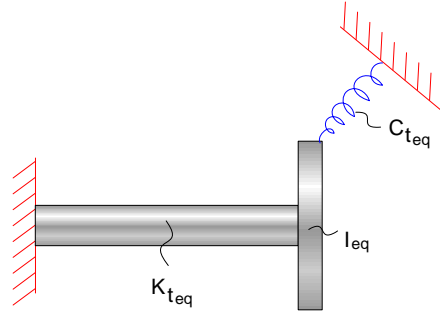

The kinetic energy of the system at hand is

$$\begin{aligned}
 T &= \frac{1}{2} m \bar{v}^2 + \frac{1}{2} I \bar{\omega}^2 \\
 &= \frac{1}{2} m \left(\frac{L}{4} \dot{\theta} \right)^2 + \frac{1}{2} \left(\frac{1}{12} mL^2 \right) \dot{\theta}^2 \\
 &= \frac{1}{2} \left(\frac{7}{48} mL^2 \right) \dot{\theta}^2
 \end{aligned} \tag{2}$$

comparing eqs.(1) and (2) leads to

$$I_{eq.} = \frac{7}{48} mL^2 \tag{3}$$

The potential energy of the equivalent system is

$$V = \frac{1}{2} k_{teq.} \theta^2 \tag{4}$$

The potential energy of the system at hand, is

$$\begin{aligned}
 V &= \frac{1}{2} k \left(\frac{3}{4} L \theta \right)^2 + \frac{1}{2} k \left(\frac{L}{4} \theta \right)^2 \\
 &= \frac{1}{2} \left(\frac{5}{8} L^2 \right) \theta^2
 \end{aligned} \tag{5}$$

Comparing eqs. (4) and (5) leads to

$$k_{teq.} = \frac{5}{8} kL^2 \tag{6}$$

The work done by the torsional viscous damper of the equivalent system is

$$U = -C_{teq} \int \dot{\theta} d\theta \tag{7}$$

The work done by this viscous dampers in the system at hand is

$$\begin{aligned}
 U &= -\int c\dot{x}_A dx_A - \int 2c\dot{x}_B dx_B \\
 &= -\int c\left(\frac{L}{2}\dot{\theta}\right)d\left(\frac{L}{2}\theta\right) - \int 2c\left(\frac{L}{4}\dot{\theta}\right)d\left(\frac{L}{4}\theta\right) \\
 &= -\frac{3}{8}cL^2 \int \dot{\theta}d\theta
 \end{aligned} \tag{8}$$

Comparing eqs.(7) and (8) leads to

$$c_{t_{eq}} = \frac{3}{8}cL^2 \tag{9}$$

The differential equation governing motion of the equivalent system is

$$I_{eq}\ddot{\theta} + c_{t_{eq}}\dot{\theta} + k_{t_{eq}}\theta = 0 \tag{10}$$

Substituting eqs.(3), (6), and (9) in eq.(10) leads to the differential equation governing the system as

$$\frac{7}{48}mL^2\ddot{\theta} + \frac{3}{8}cL^2\dot{\theta} + \frac{5}{8}kL^2\theta = 0 \tag{11}$$

Dividing eq.(11) by the coefficient of its highest derivative gives

$$\ddot{\theta} + \frac{16}{7}\frac{c}{m}\dot{\theta} + \frac{30}{7}\frac{k}{m}\theta = 0 \tag{12}$$

Problem 2.55 illustrates use of the equivalent system method to derive the differential equation for a system with viscous damping when an angular coordinate is chosen as the generalized coordinate.

2.56 Determine the differential equations governing the motion of the system by using the equivalent systems method. Use the generalized coordinates shown in Figure P2.56.

Given: m, k, c, x as generalized coordinate

Find: differential equation

Solution: The system is modeled by a mass-spring-dashpot system of equivalent mass, stiffness, and viscous damping coefficient. The kinetic energy of the equivalent system is

$$T = \frac{1}{2}m_{eq}\dot{x}^2$$

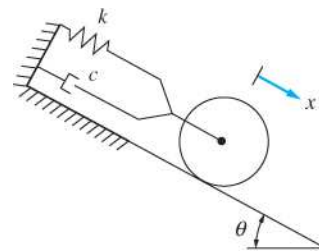

Thin disk of mass m
radius r rolls
without slip

FIGURE P 2.56

If the disk rolls without slip then its angular velocity is related to the velocity of its mass center by

$$\omega = \frac{\dot{x}}{r}$$

In this case the kinetic energy of the system is

$$\begin{aligned} T &= \frac{1}{2}m\dot{x}^2 + \frac{1}{2}\frac{I}{r^2}mr^2\left(\frac{\dot{x}}{r}\right)^2 \\ &= \frac{1}{2}\frac{3}{2}m\dot{x}^2 \end{aligned}$$

and hence

$$m_{eq} = \frac{3}{2}m$$

The potential energy of the equivalent system is

$$V = \frac{1}{2}k_{eq}x^2$$

The gravity causes a static deflection in the spring, and does not contribute to any additional potential energy. Thus, ignoring gravity and the initial potential energy in the spring,

$$V = \frac{1}{2}kx^2$$

and

$$k_{eq} = k$$

The work done by the damping force in the equivalent system is

$$W = -\int c_{eq}\dot{x}dx$$

The work done by damping force in the system at hand is

$$W = -\int c\dot{x}dx$$

Hence, $c_{eq} = c$. Thus the governing differential equation is

$$\frac{3}{2}m\ddot{x} + c\dot{x} + kx = 0$$

$$\ddot{x} + \frac{2c}{3m}\dot{x} + \frac{2k}{3m}x = 0$$

Problem 2.56 illustrates the use of the equivalent system method to derive the differential equation for a one-degree-of-freedom system.

2.57 Determine the differential equations governing the motion of the system by using the equivalent systems method. Use the generalized coordinates shown in Figure P2.57.

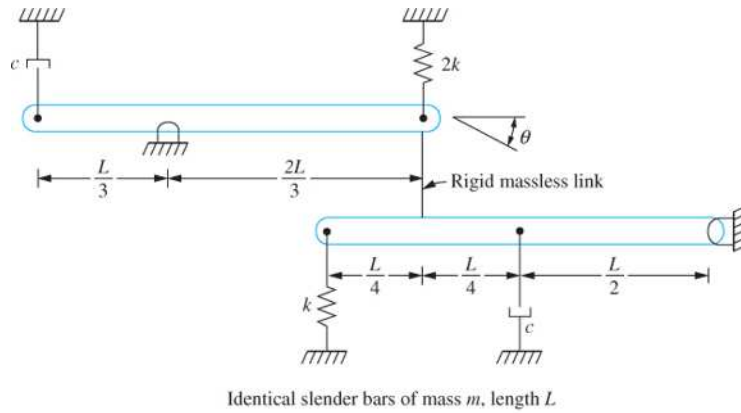

FIGURE P 2.57

Given: system shown

Find: differential equation

Solution: Let θ_2 be the counterclockwise angular displacement of the lower bar. Since the displacement of each end of the rigid rod is the same, use of the small angle approximation leads to

$$\frac{2L}{3}\theta = \frac{3L}{4}\theta_2$$

The kinetic energy of the system at an arbitrary instant is

$$T = \frac{1}{2}m\left(\frac{L}{6}\dot{\theta}\right)^2 + \frac{1}{2}\frac{1}{12}mL^2\dot{\theta}^2 + \frac{1}{2}m\left(\frac{L}{2}\dot{\theta}_2\right)^2 + \frac{1}{2}\frac{1}{12}mL^2\dot{\theta}_2^2$$

$$T = \frac{1}{2}m\left(\frac{L}{6}\dot{\theta}\right)^2 + \frac{1}{2}\frac{1}{12}mL^2\dot{\theta}^2 + \frac{1}{2}m\left(\frac{L}{2}\frac{8}{9}\dot{\theta}\right)^2 + \frac{1}{2}\frac{1}{12}mL^2\left(\frac{8}{9}\dot{\theta}\right)^2$$

$$T = \frac{1}{2}mL^2\left(\frac{1}{36} + \frac{1}{12} + \frac{16}{81} + \frac{16}{243}\right)\dot{\theta}^2$$

$$T = \frac{1}{2}\frac{91}{243}mL^2\dot{\theta}^2$$

Since an angular coordinate is chosen as the generalized coordinate the torsional system is the appropriate model system with

$$I_{eq} = \frac{91}{243} mL^2$$

The potential energy of the system at an arbitrary instant is

$$\begin{aligned} V &= \frac{1}{2} 2k \left(\frac{2L}{3} \theta \right)^2 + \frac{1}{2} k (L\theta_2)^2 \\ V &= \frac{1}{2} 2k \left(\frac{2L}{3} \theta \right)^2 + \frac{1}{2} k \left(L \frac{8}{9} \theta \right)^2 \\ V &= \frac{1}{2} kL^2 \left(\frac{8}{9} + \frac{64}{81} \right) \theta^2 \\ V &= \frac{1}{2} \frac{136}{81} kL^2 \theta^2 \end{aligned}$$

Thus,

$$k_{t_{eq}} = \frac{136}{81} kL^2$$

The work done by the viscous damper between two arbitrary times is

$$\begin{aligned} W_{1 \rightarrow 2} &= -\int c \left(\frac{L}{3} \dot{\theta} \right) d \left(\frac{L}{3} \theta \right) - \int c \left(\frac{L}{2} \dot{\theta}_2 \right) d \left(\frac{L}{2} \theta_2 \right) \\ W_{1 \rightarrow 2} &= -\int \frac{cL^2}{9} \dot{\theta} d\theta - \int \frac{cL^2}{4} \left(\frac{8}{9} \dot{\theta} \right) d \left(\frac{8}{9} \theta \right) \\ W_{1 \rightarrow 2} &= -\int cL^2 \left(\frac{1}{9} + \frac{16}{81} \right) \dot{\theta} d\theta = -\int \frac{25cL^2}{81} \dot{\theta} d\theta \end{aligned}$$

Thus the equivalent torsional damping coefficient is

$$c_{t_{eq}} = \frac{25cL^2}{81}$$

The differential equation governing the motion of the system is

$$\frac{91}{243} mL^2 \ddot{\theta} + \frac{25}{81} cL^2 \dot{\theta} + \frac{136}{81} kL^2 \theta = 0$$

The equation is put into standard form by dividing through by the coefficient of the $\ddot{\theta}$ term leading to

$$\ddot{\theta} + \frac{75c}{91m} \dot{\theta} + \frac{324k}{91m} \theta = 0$$

Chapter 2: Modeling of SDOF Systems

Problem 2.57 illustrates derivation of the governing differential equation using the equivalent systems method.

2.58 Determine the differential equations governing the motion of the system by using the equivalent systems method. Use the generalized coordinates shown in Figure P2.58.

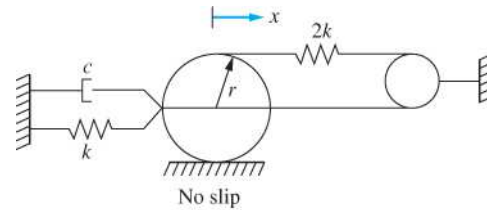

Thin disk of mass m , radius r

FIGURE P 2.58

Given: system shown

Find: differential equation

Solution: If the disk rolls without slip then the velocity of the mass center is related to the angular velocity of the disk by $\dot{x} = r\omega$. The kinetic energy of the system at an arbitrary instant is

$$T = \frac{1}{2} m \bar{v}^2 + \frac{1}{2} \bar{I} \omega^2$$

$$T = \frac{1}{2} m \dot{x}^2 + \frac{1}{2} \left(\frac{1}{2} m r^2 \right) \left(\frac{\dot{x}}{r} \right)^2$$

$$T = \frac{1}{2} \left(\frac{3}{2} m \right) \dot{x}^2$$

Thus the equivalent mass of the system is

$$m_{eq} = \frac{3}{2} m$$

The potential energy developed in a spring is proportional to the square of the change in length of the spring. If the center of the disk displaces a distance x from equilibrium the end of the spring attached to the center of the disk displaces x . The point at the top of the disk where the spring is attached translates a distance x and rotates through an angle θ . Since the disk rolls without slip $\theta = x/r$. Thus the total displacement of that end of the spring is $x + r\theta = 2x$. Then the total change in length of the spring is $3x$. The potential energy of the system at an arbitrary instant is

$$V = \frac{1}{2} k x^2 + \frac{1}{2} 2k (3x)^2$$

$$V = \frac{1}{2} (19k) x^2$$

Thus the equivalent stiffness of the system is

$$k_{eq} = 19k$$

The work done by the viscous damper between two arbitrary positions is

$$W_{1 \rightarrow 2} = - \int_{x_1}^{x_2} c \dot{x} dx$$

The equivalent viscous damping coefficient for the system is

$$c_{eq} = c$$

The differential equation governing the motion of the system is

$$\frac{3}{2} m \ddot{x} + c \dot{x} + 19kx = 0$$

The differential equation is put into standard form by dividing by the coefficient of \ddot{x} leading to

$$\ddot{x} + \frac{2c}{3m} \dot{x} + \frac{38k}{3m} x = 0$$

Problem 2.58 illustrates derivation of the differential equation governing the motion of a linear one-degree-of-freedom system using the equivalent systems method.

2.59 Determine the differential equations governing the motion of the system by using the equivalent systems method. Use the generalized coordinates shown in Figure P2.59.

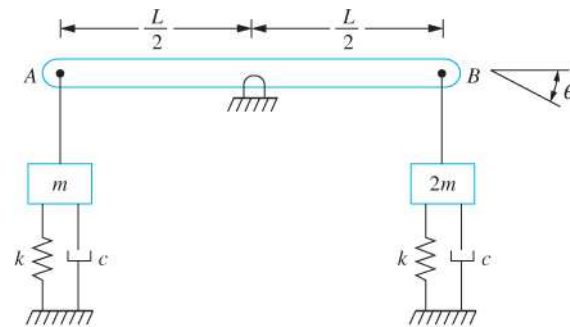

Slender bar of mass m connected to blocks through rigid links at A and B

FIGURE P 2.59

Given: system shown

Find: differential equation, ω_n

Solution: The kinetic energy of the system at an arbitrary instant is

$$T = \frac{1}{2} \frac{1}{12} mL^2 \dot{\theta}^2 + \frac{1}{2} m \left(\frac{L}{2} \dot{\theta} \right)^2 + \frac{1}{2} 2m \left(\frac{L}{2} \dot{\theta} \right)^2$$

$$T = \frac{1}{2} \left(\frac{5}{6} mL^2 \right) \dot{\theta}^2$$

Chapter 2: Modeling of SDOF Systems

Since an angular coordinate is chosen as the generalized coordinate the equivalent system model is the torsional system. The equivalent moment of inertia of the system is

$$I_{eq} = \frac{5}{6} mL^2$$

The potential energy of the system at an arbitrary instant is

$$V = \frac{1}{2} k \left(\frac{L}{2} \theta \right)^2 + \frac{1}{2} k \left(\frac{L}{2} \theta \right)^2$$
$$V = \frac{1}{2} \left(\frac{1}{2} kL^2 \right) \theta^2$$

The equivalent torsional stiffness is

$$k_{teq} = \frac{1}{2} kL^2$$

The work done by the viscous dampers between two arbitrary positions is

$$W_{1 \rightarrow 2} = - \int c \left(\frac{L}{2} \dot{\theta} \right) d \left(\frac{L}{2} \theta \right) - \int c \left(\frac{L}{2} \dot{\theta} \right) d \left(\frac{L}{2} \theta \right)$$
$$W_{1 \rightarrow 2} = - \int_{\theta_1}^{\theta_2} \left(c \frac{L^2}{2} \right) \dot{\theta} d\theta$$

The equivalent torsional viscous damping coefficient is

$$c_{teq} = \frac{1}{2} cL^2$$

The differential equation governing the motion of the system is

$$\frac{5}{6} mL^2 \ddot{\theta} + \frac{1}{2} cL^2 \dot{\theta} + \frac{1}{2} kL^2 \theta = 0$$

The differential equation is put into standard form by dividing by the coefficient of $\ddot{\theta}$ leading to

$$\ddot{\theta} + \frac{3c}{5m} \dot{\theta} + \frac{3k}{5m} \theta = 0$$

Problem 2.59 illustrates the application of the equivalent systems method to derive the differential equation governing the motion of a linear one-degree-of-freedom system.

2.60 Determine the differential equations governing the motion of the system by using the equivalent systems method. Use the generalized coordinates shown in Figure P2.60.

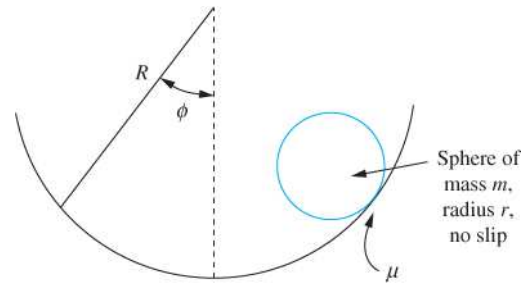

FIGURE P 2.60

Given: system shown

Find: differential equation

Solution: The generalized coordinate is chosen as ϕ the angle made between the normal to the sphere and the surface at any instant. Let θ be an angular coordinate representing the angular displacement of the sphere. If the sphere rolls without slip, then the distance traveled by the mass center of the sphere is

$$x = r\theta$$

However the mass center of the sphere is also traveling in a circular path of radius $(R-r)$. Thus the distance traveled by the mass center is also equal to

$$x = (R - r)\phi$$

Equating x between the two equations leads to

$$\theta = \frac{R - r}{r} \phi$$

The kinetic energy of the system at an arbitrary instant is

$$T = \frac{1}{2} m \dot{x}^2 + \frac{1}{2} I \dot{\theta}^2$$

$$T = \frac{1}{2} m \left[(R - r)^2 \dot{\phi}^2 + \frac{2}{5} r^2 \left(\frac{R - r}{r} \right)^2 \dot{\phi}^2 \right]$$

$$T = \frac{1}{2} \left[\frac{7}{5} m (R - r)^2 \right] \dot{\phi}^2$$

Hence the equivalent moment of inertia is

$$I_{eq} = \frac{7}{5} m (R - r)^2$$

The datum for potential energy calculations is taken as the position of the mass center of the sphere when it is in equilibrium at the bottom of the circular path. The potential energy at an arbitrary instant is

$$V = mg(R - r) \cos \phi$$

Chapter 2: Modeling of SDOF Systems

Use of the small angle assumption leads to

$$V = \frac{1}{2} mg(R - r)\phi^2$$

Thus the equivalent torsional stiffness is

$$k_{t,eq} = mg(R - r)$$

The differential equation governing the motion of the system is

$$\frac{7}{5} m(R - r)^2 \ddot{\phi} + mg(R - r)\phi = 0$$

The differential equation is put into standard form by dividing by the coefficient multiplying the highest order derivative. This leads to

$$\ddot{\phi} + \frac{5g}{7(R - r)}\phi = 0$$

Problem 2.60 illustrates the application of the equivalent systems method to derive the differential equation governing the motion of a one-degree-of-freedom linear system with an angular displacement as the chosen generalized coordinate.

2.61 Determine the differential equations governing the motion of the system by using the equivalent systems method. Use the generalized coordinates shown in Figure P2.61.

Given: system shown

Find: differential equation

Solution: The kinetic energy of the system is $T = T_b + T_s$ where T_b is the kinetic energy of the bar and T_s is the kinetic energy of the sphere. The kinetic energy of the sphere is assuming no slipping

$$T_s = \frac{1}{2} m\dot{x}^2 + \frac{1}{2} \left(\frac{1}{2} mr^2 \right) \left(\frac{\dot{x}}{r} \right)^2 = \frac{1}{2} \frac{3m}{2} \dot{x}^2$$

Let θ (small) be the angular rotation of the bar. Both ends of the rigid link have the same displacement, thus

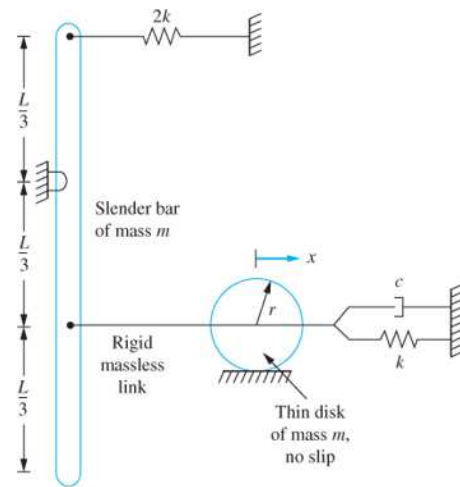

FIGURE P 2.61

$$x = \frac{L}{3}\theta \Rightarrow \theta = \frac{3x}{L}$$

The kinetic energy of the bar is

$$T_b = \frac{1}{2}m \left[\frac{L}{6} \left(\frac{3\dot{x}}{L} \right) \right]^2 + \frac{1}{2} \left(\frac{1}{12}mL^2 \right) \left(\frac{3\dot{x}}{L} \right)^2 = \frac{1}{2}m\dot{x}^2$$

Hence the total kinetic energy of the system is

$$T = \frac{1}{2} \frac{3m}{2} \dot{x}^2 + \frac{1}{2}m\dot{x}^2 = \frac{1}{2} \frac{5m}{2} \dot{x}^2$$

The equivalent mass of the system is $\frac{5m}{2}$. The potential energy of the system is

$$V = \frac{1}{2}kx^2 + \frac{1}{2}2k \left[\frac{L}{3} \left(\frac{3x}{L} \right) \right]^2 + \frac{mgL}{6}(1 - \cos \theta)$$

Using the small angle assumption and approximating $1 - \cos \theta$ as $\frac{1}{2}\theta^2 = \frac{1}{2} \left(\frac{3x}{L} \right)^2$ leads to the potential energy of

$$V = \frac{1}{2} \left(3k + \frac{3mg}{2L} \right) x^2$$

The equivalent stiffness of the system is $3k + \frac{3mg}{2L}$. The work done by the viscous damping force is

$$U = - \int c\dot{x} dx$$

The equivalent viscous damping coefficient is c . The differential equation is

$$\frac{5m}{2}\ddot{x} + c\dot{x} + \left(3k + \frac{3mg}{2L} \right) x = 0$$

Problem 2.61 illustrates the application of the equivalent systems method to derive the differential equation governing the motion of a one-degree-of-freedom linear system with a linear displacement as the chosen generalized coordinate and gravity as a source of potential energy.