

## Unit 2 Problem Solutions

2.1 See FLD p. 731 for solution.

2.2 (a) In both cases, if  $X = 0$ , the transmission is 0, and if  $X = 1$ , the transmission is 1.

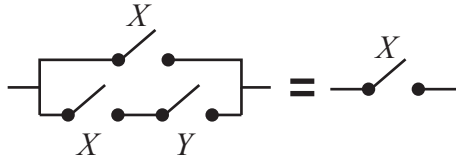

2.2 (b) In both cases, if  $X = 0$ , the transmission is  $YZ$ , and if  $X = 1$ , the transmission is 1.

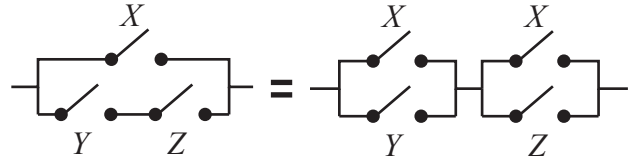

2.3 Answer is in FLD p. 731

2.4 (a)  $F = [(A \cdot 1) + (A \cdot 1)] + E + BCD = A + E + BCD$

2.4 (b)  $Y = (AB' + (AB + B)) B + A = (AB' + B) B + A = (A + B) B + A = AB + B + A = A + B$

2.5 (a)  $(A + B)(C + B)(D' + B)(ACD' + E)$   
 $= (AC + B)(D' + B)(ACD' + E)$  By Dist. Law  
 $= (ACD' + B)(ACD' + E)$  By Dist. Law  
 $= ACD' + BE$  By Dist. Law

2.5 (b)  $(A' + B + C')(A' + C' + D)(B' + D')$   
 $= (A' + C' + BD)(B' + D')$   
 {By Distributive Law with  $X = A' + C'$ }  
 $= A'B' + B'C' + B'BD + A'D' + C'D' + BDD'$   
 $= A'B' + A'D' + C'B' + C'D'$

2.6 (a)  $AB + C'D' = (AB + C')(AB + D')$   
 $= (A + C')(B + C')(A + D')(B + D')$

2.6 (b)  $WX + WY'X + ZYX = X(W + WY' + ZY)$   
 $= X(W + ZY)$  {By Absorption}  
 $= X(W + Z)(W + Y)$

2.6 (c)  $A'BC + EF + DEF' = A'BC + E(F + DF')$   
 $= A'BC + E(F + D) = (A'BC + E)(A'BC + F + D)$   
 $= (A' + E)(B + E)(C + E)(A' + F + D)$   
 $(B + F + D)(C + F + D)$

2.6 (d)  $XYZ + W'Z + XQ'Z = Z(XY + W' + XQ')$   
 $= Z[W' + X(Y + Q')]$   
 $= Z(W' + X)(W' + Y + Q')$  By Distributive Law

2.6 (e)  $ACD' + C'D' + A'C = D'(AC + C') + A'C$   
 $= D'(A + C) + A'C$  By Elimination Theorem  
 $= (D' + A'C)(A + C' + A'C)$   
 $= (D' + A')(D' + C)(A + C' + A')$   
 By Distributive Law and Elimination Theorem  
 $= (A' + D')(C + D')$

2.6 (f)  $A + BC + DE$   
 $= (A + BC + D)(A + BC + E)$   
 $= (A + B + D)(A + C + D)(A + B + E)(A + C + E)$

2.7 (a)  $(A + B + C + D)(A + B + C + E)(A + B + C + F)$   
 $= A + B + C + DEF$   
 Apply second Distributive Law twice

2.7 (b)  $WXYZ + VXYZ + UXYZ = XYZ(W + V + U)$   
 By first Distributive Law

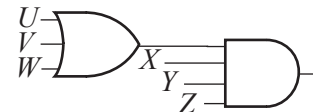
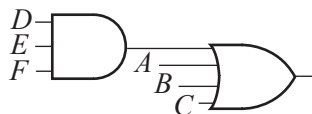

2.8 (a)  $[(AB)' + C'D]' = AB(C'D)' = AB(C + D')$   
 $= ABC + ABD'$

2.8 (b)  $[A + B(C' + D)]' = A'(B(C' + D))'$   
 $= A'(B' + (C' + D)') = A'(B' + CD')$   
 $= A'B' + A'CD'$

2.8 (c)  $((A + B')C')(A + B)(C + A)'$   
 $= (A'B + C')(A + B)C'A' = (A'B + C')A'B'C'$   
 $= A'B'C'$

2.9 (a)  $F = [(A + B)' + (A + (A + B)')] (A + (A + B)')'$   
 $= (A + (A + B)')'$   
 By Elimination Theorem with  
 $X = (A + (A + B)')' = A'(A + B) = A'B$

2.9 (b)  $G = \{[(R + S + T)' PT(R + S)]' T\}'$   
 $= (R + S + T)' PT(R + S)' + T'$   
 $= T' + (R'S'T) P(R'S)T = T' + PR'S'T'T = T'$

## Unit 2 Solutions

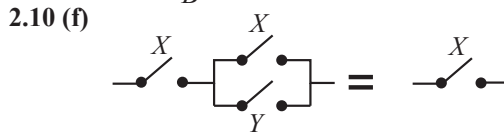
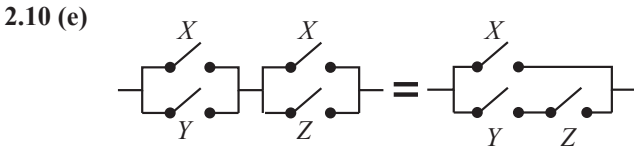
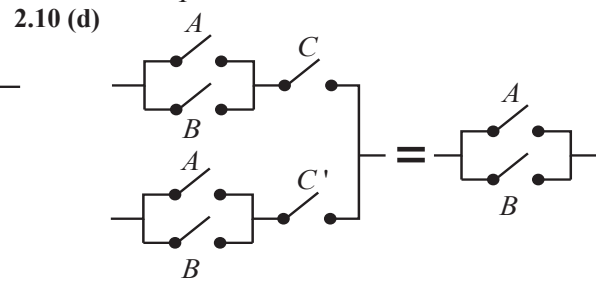
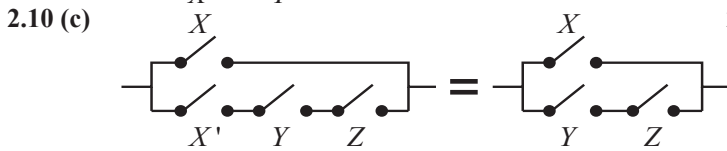
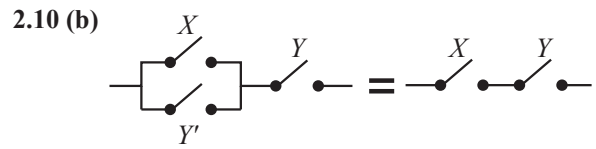
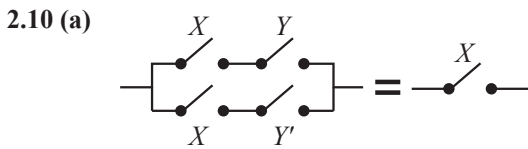

2.11 (a)  $(A' + B' + C)(A' + B' + C)' = 0$  By Complementary Law

2.11 (b)  $AB(C' + D) + B(C' + D) = B(C' + D)$  By Absorption

2.11 (c)  $AB + (C' + D)(AB)' = AB + C' + D$  By Elimination Theorem

2.11 (d)  $(A'BF + CD')(A'BF + CEG) = A'BF + CD'EG$  By Distributive Law

2.11 (e)  $[AB' + (C + D)' + E'F](C + D) = AB'(C + D) + E'F(C + D)$  Distributive Law

2.11 (f)  $A'(B + C)(D'E + F)' + (D'E + F) = A'(B + C) + D'E + F$  By Elimination

2.12 (a)  $(X + Y'Z) + (X + Y'Z)' = 1$  By Complementary Law

2.12 (b)  $[W + X'(Y + Z)][W' + X'(Y + Z)] = X'(Y + Z)$  By Uniting Theorem

2.12 (c)  $(V'W + UX)'(UX + Y + Z + V'W) = (V'W + UX)'(Y + Z)$  By Elimination Theorem

2.12 (d)  $(UV' + W'X)(UV' + W'X + Y'Z) = UV' + W'X$  By Absorption Theorem

2.12 (e)  $(W' + X)(Y + Z') + (W' + X)'(Y + Z) = (Y + Z')$  By Uniting Theorem

2.12 (f)  $(V' + U + W)[(W + X) + Y + UZ'] + [(W + X) + UZ' + Y] = (W + X) + UZ' + Y$  By Absorption

2.13 (a)  $F_1 = A'A + B + (B + B) = 0 + B + B = B$

2.13 (b)  $F_2 = A'A' + AB' = A' + AB' = A' + B'$

2.13 (c)  $F_3 = [(AB + C)'D][(AB + C) + D] = (AB + C)'D(AB + C) + (AB + C)'D = (AB + C)'D$  By Absorption

2.13 (d)  $Z = [(A + B)C]' + (A + B)CD = [(A + B)C]' + D$  By Elimination with  $X = [(A + B)C]'$   
 $= A'B' + C' + D'$

2.14 (a)  $ACF(B + E + D)$

2.14 (b)  $W + Y + Z + VUX$

2.15 (a)  $f' = \{[A + (BCD)][(AD)' + B(C' + A)]\}' = [A + (BCD)]' + [(AD)' + B(C' + A)]' = A'(BCD)'' + (AD)''[B(C' + A)]' = A'BCD + AD[B' + (C' + A)] = A'BCD + AD[B' + C'A] = A'BCD + AD[B' + CA]$

2.15 (b)  $f' = [AB'C + (A' + B + D)(ABD' + B')] = (AB'C)[(A' + B + D)(ABD' + B')] = (A' + B' + C)[(A' + B + D)' + (ABD')'B''] = (A' + B + C)[A''B'D' + (A' + B' + D'')B] = (A' + B + C)[AB'D' + (A' + B' + D)B]$

2.16 (a)  $f^D = [A + (BCD)][(AD)' + B(C' + A)]^D = [A(B + C + D)] + [(A + D)(B + C'A)]$

2.16 (b)  $f^D = [AB'C + (A' + B + D)(ABD' + B')]^D = (A + B' + C)[A'BD + (A + B + D')B']$

2.17 (a)  $f = [(A' + B)C] + [A(B + C')] = A'C + B'C + AB + AC' = A'C + B'C + AB + AC' + BC = A'C + C + AB + AC' = C + AB + A = C + A$

2.17 (b)  $f = A'C + B'C + AB + AC' = A + C$

2.17 (c)  $f = (A' + B' + A)(A + C)(A' + B' + C' + B)(B + C + C') = (A + C)$

2.18 (a) product term, sum-of-products, product-of-sums)

## Unit 2 Solutions

2.18 (b) sum-of-products

2.18 (d) sum term, sum-of-products, product-of-sums

2.19

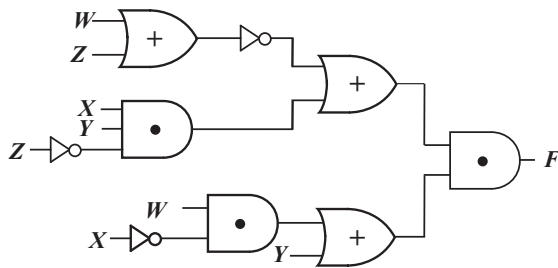

$$\begin{aligned} 2.20 \text{ (c)} \quad F &= D[(A' + B')C + AC'] \\ &= D(A' + B' + AC')(C + AC') \\ &= D(A' + B' + C')(C + A) \end{aligned}$$

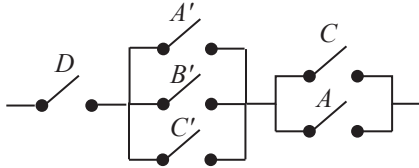

$$\begin{aligned} 2.22 \text{ (a)} \quad A'B' + A'CD + A'DE' \\ &= A'(B' + CD + DE') \\ &= A'[B' + D(C + E')] \\ &= A'(B' + D)(B' + C + E') \end{aligned}$$

$$\begin{aligned} 2.22 \text{ (b)} \quad H'I' + JK \\ &= (H'I' + J)(H'I' + K) \\ &= (H' + J)(I' + J)(H' + K)(I' + K) \end{aligned}$$

$$\begin{aligned} 2.22 \text{ (c)} \quad A'BC + AB'C + CD' \\ &= C(A'B + AB' + D') \\ &= C[(A + B)(A' + B') + D'] \\ &= C(A + B + D')(A' + B' + D') \end{aligned}$$

$$2.23 \text{ (a)} \quad W + U'YV = (W + U')(W + Y)(W + V)$$

$$\begin{aligned} 2.23 \text{ (c)} \quad A'B'C + B'CD' + B'E' &= B'(A'C + CD' + E') \\ &= B'[E' + C(A' + D')] \\ &= B'(E' + C)(E' + A' + D') \end{aligned}$$

2.18 (c) none apply

2.18 (e) product-of-sums

$$2.20 \text{ (a)} \quad F = D[(A' + B')C + AC']$$

$$2.20 \text{ (b)} \quad F = D[(A' + B')C + AC'] \\ = A'CD + B'CD + AC'D$$

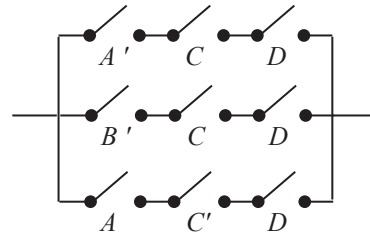

A	B	C	H	F	G
0	0	0	0	0	0
0	0	1	1	1	x
0	1	0	1	0	1
0	1	1	1	1	x
1	0	0	0	0	0
1	0	1	1	0	1
1	1	0	0	0	0
1	1	1	1	1	x

$$\begin{aligned} 2.22 \text{ (d)} \quad A'B' + (CD' + E) &= A'B' + (C + E)(D' + E) \\ &= (A'B' + C + E)(A'B' + D' + E) \\ &= (A' + C + E)(B' + C + E) \\ &\quad (A' + D' + E)(B' + D' + E) \end{aligned}$$

$$\begin{aligned} 2.22 \text{ (e)} \quad A'B'C + B'CD' + EF' &= A'B'C + B'CD' + EF' \\ &= B'C(A' + D') + EF' \\ &= (B'C + EF')(A' + D' + EF') \\ &= (B' + E)(B' + F')(C + E)(C + F') \\ &\quad (A' + D' + E)(A' + D' + F') \end{aligned}$$

$$\begin{aligned} 2.22 \text{ (f)} \quad WX'Y + W'X' + W'Y' &= X'(WY + W') + W'Y' \\ &= X'(W' + Y) + W'Y' \\ &= (X' + W')(X' + Y)(W' + Y + W')(W' + Y + Y') \\ &= (X' + W')(X' + Y)(W' + Y) \end{aligned}$$

$$\begin{aligned} 2.23 \text{ (b)} \quad TW + UY' + V \\ &= (T + U + Z)(T + Y' + V)(W + U + V)(W + Y' + V) \end{aligned}$$

$$\begin{aligned} 2.23 \text{ (d)} \quad ABC + ADE' + ABF' &= A(BC + DE' + BF') \\ &= A[DE' + B(C + F')] \\ &= A(DE' + B)(DE' + C + F') \\ &= A(B + D)(B + E)(C + F' + D)(C + F' + E') \end{aligned}$$

## Unit 2 Solutions

**2.24 (a)**  $[(XY)'] + (X' + Y)Z = X' + Y + (X' + Y)Z$   
 $= X' + Y + Z$  By Elimination Theorem with  $X = (X' + Y)$   
 $= (X' + Y)$

**2.24 (c)**  $[(A' + B)'] + (A'B'C) + C'D]'$   
 $= (A' + B)A'B'C(C + D) = A'B'C$

**2.25 (a)**  $F(P, Q, R, S) = [(R' + PQ)S]' = R(P' + Q') + S'$   
 $= RP' + RQ' + S'$

**2.25 (c)**  $F(A, B, C, D) = [A' + B' + ACD]'$   
 $= [A' + B' + CD]' = AB(C' + D')$

**2.26 (a)**  $F = [(A' + B)B]C + B = [A' + B + B]C + B$   
 $= C + B$

**2.26 (c)**  $H = [W'X'(Y' + Z)'] = W + X + YZ$

**2.28 (a)**  $F = ABC + A'BC + AB'C + ABC'$   
 $= BC + AB'C + ABC'$  (By Uniting Theorem)  
 $= C(B + AB') + ABC' = C(A + B) + ABC'$   
 (By Elimination Theorem)  
 $= AC + BC + ABC' = AC + B(C + AC')$   
 $= AC + B(A + C) = AC + AB + BC$

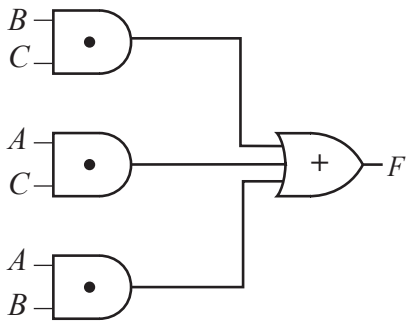

**2.29 (a)**

$XYZ$	$X+Y$	$X'+Z$	$(X+Y)$ $(X'+Z)$	$XZ$	$X'Y$	$XZ+X'Y$
000	0	1	0	0	0	0
001	0	1	0	0	0	0
010	1	1	1	0	1	1
011	1	1	1	0	1	1
100	1	0	0	0	0	0
101	1	1	1	1	0	1
110	1	0	0	0	0	0
111	1	1	1	1	0	1

**2.24 (b)**  $(X + (Y'(Z + W)))' = X'Y'(Z + W)' = X'Y'Z'W'$

**2.24 (d)**  $(A + B)CD + (A + B)' = CD + (A + B)'$   
 {By Elimination Theorem with  $X = (A + B)$ }  
 $= CD + A'B'$

**2.25 (b)**  $F(W, X, Y, Z) = [X + YZ(W + X)']'$   
 $= [X + X'YZ + WYZ]'$   
 $= [X + YZ + WYZ]' = [X + YZ]'$   
 $= X'Y' + X'Z'$

**2.26 (b)**  $G = [(AB)'(B + C)]'C = (AB + B'C)C = ABC$

**2.27**  $F = (V + X + W)(V + X + Y)(V + Z)$   
 $= (V + X + WY)(V + Z) = V + Z(X + WY)$   
 By Distributive Law with  $X = V$

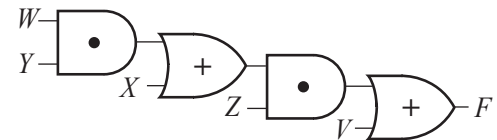

**2.28 (b)** Beginning with the answer to (a):

$F = A(B + C) + BC$

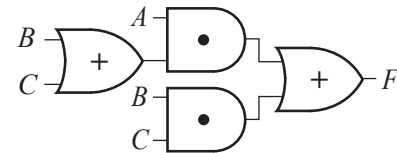

Alternate solutions:

$F = AB + C(A + B)$

$F = AC + B(A + C)$

**2.29 (b)**

$XYZ$	$X+Y$	$Y+Z$	$X'+Z$	$(X+Y)$ $(Y+Z)$ $(X'+Z)$	$(X+Y)$ $(X'+Z)$
000	0	0	1	0	0
001	0	1	1	0	0
010	1	1	1	1	1
011	1	1	1	1	1
100	1	0	0	0	0
101	1	1	1	1	1
110	1	1	0	0	0
111	1	1	1	1	1

## Unit 2 Solutions

2-29 (c)

$XYZ$	$XY$	$YZ$	$X'Z$	$XY+YZ+X'Z$	$XY+X'Z$
000	0	0	0	0	0
001	0	0	1	1	1
010	0	0	0	0	0
011	0	1	1	1	1
100	0	0	0	0	0
101	0	0	0	0	0
110	1	0	0	1	1
111	1	1	0	1	1

2.29 (d)

$ABC$	$A+C$	$AB+C'$	$(A+C)(AB+C')$	$AB$	$AC'$	$AB+AC'$
000	0	1	0	0	0	0
001	1	0	0	0	0	0
010	0	1	0	0	0	0
011	1	0	0	0	0	0
100	1	1	1	0	1	1
101	1	0	0	0	0	0
110	1	1	1	1	1	1
111	1	1	1	1	0	1

2.29 (e)

$WXYZ$	$W'XY$	$WZ$	$W'XY+WZ$	$W'+Z$	$W+XY$	$(W'+Z)(W+XY)$
0000	0	0	0	1	0	0
0001	0	0	0	1	0	0
0010	0	0	0	1	0	0
0011	0	0	0	1	0	0
0100	0	0	0	1	0	0
0101	0	0	0	1	0	0
0110	1	0	1	1	1	1
0111	1	0	1	1	1	1
1000	0	0	0	0	1	0
1001	0	1	1	1	1	1
1010	0	0	0	0	1	0
1011	0	1	1	1	1	1
1100	0	0	0	0	1	0
1101	0	1	1	1	1	1
1110	0	0	0	0	1	0
1111	0	1	1	1	1	1

2.30

$$\begin{aligned}
 F &= (X+Y)Z + X'YZ' \\
 &= (X+Y+X'YZ')(Z+X'YZ') \\
 &= (X+Y+X')(X+Y+Y)(X+Y+Z')(Z+X')(Z+Y)(Z+Z') \\
 &= (1+Y')(X+1)(X+Y+Z')(Z+X')(Z+Y)(1) \\
 &= (1)(1)(X+Y+Z')(Z+X')(Z+Y)(1) \\
 &= (X+Y+Z')(Z+X')(Z+Y)
 \end{aligned}$$

(from the circuit)  
 (Distributive Law)  
 (Distributive Law)  
 (Complementation Laws)  
 (Operations with 0 and 1)  
 (Operations with 0 and 1)

$$G = (X+Y'+Z')(X'+Z)(Y+Z)$$

(from the circuit)

## Unit 2 Solutions