

## **Solutions Manual for**

**Fluid Mechanics: Fundamentals and Applications**

**Fourth Edition**

**Yunus A. Çengel & John M. Cimbala**

**McGraw-Hill Education, 2018**

# **Chapter 2**

## **PROPERTIES OF FLUIDS**

### **PROPRIETARY AND CONFIDENTIAL**

This Manual is the proprietary property of McGraw-Hill Education and protected by copyright and other state and federal laws. By opening and using this Manual the user agrees to the following restrictions, and if the recipient does not agree to these restrictions, the Manual should be promptly returned unopened to McGraw-Hill Education: **This Manual is being provided only to authorized professors and instructors for use in preparing for the classes using the affiliated textbook. No other use or distribution of this Manual is permitted. This Manual may not be sold and may not be distributed to or used by any student or other third party. No part of this Manual may be reproduced, displayed or distributed in any form or by any means, electronic or otherwise, without the prior written permission of McGraw-Hill Education.**

---

**Density and Specific Gravity**

---

**2-1C**

**Solution** We are to discuss the difference between intensive and extensive properties.

**Analysis** *Intensive properties do not depend on the size (extent) of the system but extensive properties do depend on the size (extent) of the system.*

**Discussion** An example of an intensive property is temperature. An example of an extensive property is mass.

---

**2-2C**

**Solution** We are to discuss the difference between mass and molar mass.

**Analysis** Mass  $m$  is the **actual mass in grams or kilograms**; molar mass  $M$  is the **mass per mole in grams/mol or kg/kmol**. These two are related to each other by  $m = NM$ , where  $N$  is the number of moles.

**Discussion** Mass, number of moles, and molar mass are often confused. Molar mass is also called *molecular weight*.

---

**2-3C**

**Solution** We are to define specific gravity and discuss its relationship to density.

**Analysis** The *specific gravity*, or *relative density*, is defined as **the ratio of the density of a substance to the density of some standard substance at a specified temperature** (the standard is water at 4°C, for which  $\rho_{\text{H}_2\text{O}} = 1000 \text{ kg/m}^3$ ). That is,  $SG = \rho/\rho_{\text{H}_2\text{O}}$ . When specific gravity is known, density is determined from  $\rho = SG \times \rho_{\text{H}_2\text{O}}$ .

**Discussion** Specific gravity is dimensionless and unitless [it is just a number without dimensions or units].

---

## 2-4C

**Solution** We are to decide if the specific weight is an extensive or intensive property.

**Analysis** The original specific weight is

$$\gamma_1 = \frac{W}{V}$$

If we were to divide the system into two halves, each half weighs  $W/2$  and occupies a volume of  $V/2$ . The specific weight of one of these halves is

$$\gamma = \frac{W/2}{V/2} = \gamma_1$$

which is the same as the original specific weight. Hence, **specific weight is an intensive property**.

**Discussion** If specific weight were an *extensive* property, its value for half of the system would be halved.

---

## 2-5C

**Solution** We are to discuss the applicability of the ideal gas law.

**Analysis** A gas can be treated as an *ideal gas* when it is **at a high temperature and/or a low pressure relative to its critical temperature and pressure**.

**Discussion** Air and many other gases at room temperature and pressure can be approximated as ideal gases without any significant loss of accuracy.

---

## 2-6C

**Solution** We are to discuss the difference between  $R$  and  $R_u$ .

**Analysis**  $R_u$  is the **universal gas constant** that is the **same for all gases**, whereas  $R$  is the **specific gas constant** that is **different for different gases**. These two are related to each other by  $R = R_u / M$ , where  $M$  is the *molar mass* (also called the *molecular weight*) of the gas.

**Discussion** Since molar mass has dimensions of mass per mole,  $R$  and  $R_u$  do not have the same dimensions or units.

---

## 2-7

**Solution** The pressure in a container that is filled with air is to be determined.

**Assumptions** At specified conditions, air behaves as an ideal gas.

**Properties** The gas constant of air is  $R = 0.287 \frac{\text{kJ}}{\text{kg} \cdot \text{K}} \left( \frac{\text{kPa} \cdot \text{m}^3}{\text{kJ}} \right) = 0.287 \frac{\text{kPa} \cdot \text{m}^3}{\text{kg} \cdot \text{K}}$  (see also Table A-1).

**Analysis** The definition of the specific volume gives

$$\nu = \frac{V}{m} = \frac{0.075 \text{ m}^3}{1 \text{ kg}} = 0.075 \text{ m}^3/\text{kg}$$

Using the ideal gas equation of state, the pressure is

$$P\nu = RT \rightarrow P = \frac{RT}{\nu} = \frac{(0.287 \text{ kPa} \cdot \text{m}^3/\text{kg} \cdot \text{K})(27 + 273 \text{ K})}{0.075 \text{ m}^3/\text{kg}} = \mathbf{1148 \text{ kPa}}$$

**Discussion** In ideal gas calculations, it saves time to convert the gas constant to appropriate units.

---

## 2-8E

**Solution** The volume of a tank that is filled with argon at a specified state is to be determined.

**Assumptions** At specified conditions, argon behaves as an ideal gas.

**Properties** The gas constant of argon is obtained from Table A-1E,  $R = 0.2686 \text{ psia} \cdot \text{ft}^3/\text{lbm} \cdot \text{R}$ .

**Analysis** According to the ideal gas equation of state,

$$\nu = \frac{mRT}{P} = \frac{(1 \text{ lbm})(0.2686 \text{ psia} \cdot \text{ft}^3/\text{lbm} \cdot \text{R})(100 + 460 \text{ R})}{200 \text{ psia}} = \mathbf{0.7521 \text{ ft}^3}$$

**Discussion** In ideal gas calculations, it saves time to write the gas constant in appropriate units.

---

## 2-9E

**Solution** The specific volume of oxygen at a specified state is to be determined.

**Assumptions** At specified conditions, oxygen behaves as an ideal gas.

**Properties** The gas constant of oxygen is obtained from Table A-1E,  $R = 0.3353 \text{ psia} \cdot \text{ft}^3/\text{lbm} \cdot \text{R}$ .

**Analysis** According to the ideal gas equation of state,

$$\nu = \frac{RT}{P} = \frac{(0.3353 \text{ psia} \cdot \text{ft}^3/\text{lbm} \cdot \text{R})(80 + 460 \text{ R})}{40 \text{ psia}} = \mathbf{4.53 \text{ ft}^3/\text{lbm}}$$

**Discussion** In ideal gas calculations, it saves time to write the gas constant in appropriate units.

---

## 2-10

**Solution** The volume and the weight of a fluid are given. Its mass and density are to be determined.

**Analysis** Knowing the weight, the mass and the density of the fluid are determined to be

$$m = \frac{W}{g} = \frac{225 \text{ N}}{9.80 \text{ m/s}^2} \left( \frac{1 \text{ kg} \cdot \text{m/s}^3}{1 \text{ N}} \right) = \mathbf{23.0 \text{ kg}}$$

$$\rho = \frac{m}{V} = \frac{23.0 \text{ kg}}{24 \text{ L}} = \mathbf{0.957 \text{ kg/L}}$$

**Discussion** Note that mass is an intrinsic property, but weight is not.

---

## 2-11E

**Solution** An automobile tire is under-inflated with air. The amount of air that needs to be added to the tire to raise its pressure to the recommended value is to be determined.

**Assumptions** 1 At specified conditions, air behaves as an ideal gas. 2 The volume of the tire remains constant.

**Properties** The gas constant of air is  $R_u = 53.34 \frac{\text{ft} \cdot \text{lbf}}{\text{lbm} \cdot \text{R}} \left( \frac{1 \text{ psia}}{144 \text{ lbf/ft}^2} \right) = 0.3704 \frac{\text{psia} \cdot \text{ft}^3}{\text{lbm} \cdot \text{R}}$

**Analysis** The initial and final absolute pressures in the tire are

$$P_1 = P_{g1} + P_{atm} = 22 + 14.6 = 36.6 \text{ psia}$$

$$P_2 = P_{g2} + P_{atm} = 30 + 14.6 = 44.6 \text{ psia}$$

Treating air as an ideal gas, the initial mass in the tire is

$$m_1 = \frac{P_1 V}{RT_1} = \frac{(36.6 \text{ psia})(2.60 \text{ ft}^3)}{(0.3704 \text{ psia} \cdot \text{ft}^3/\text{lbm} \cdot \text{R})(70 + 460 \text{ R})} = 0.4847 \text{ lbm}$$

Tire  
2.60 ft<sup>3</sup>  
70°F  
22 psia

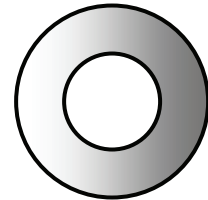

Noting that the temperature and the volume of the tire remain constant, the final mass in the tire becomes

$$m_2 = \frac{P_2 V}{RT_2} = \frac{(44.6 \text{ psia})(2.60 \text{ ft}^3)}{(0.3704 \text{ psia} \cdot \text{ft}^3/\text{lbm} \cdot \text{R})(70 + 460 \text{ R})} = 0.5907 \text{ lbm}$$

Thus the amount of air that needs to be added is

$$\Delta m = m_2 - m_1 = 0.5907 - 0.4847 = \mathbf{0.106 \text{ lbm}}$$

**Discussion** Notice that *absolute* rather than gage pressure must be used in calculations with the ideal gas law.

---

## 2-12

**Solution** An automobile tire is inflated with air. The pressure rise of air in the tire when the tire is heated and the amount of air that must be bled off to reduce the temperature to the original value are to be determined.

**Assumptions** 1 At specified conditions, air behaves as an ideal gas. 2 The volume of the tire remains constant.

**Properties** The gas constant of air is  $R = 0.287 \frac{\text{kJ}}{\text{kg} \cdot \text{K}} \left( \frac{\text{kPa} \cdot \text{m}^3}{\text{kJ}} \right) = 0.287 \frac{\text{kPa} \cdot \text{m}^3}{\text{kg} \cdot \text{K}}$ .

**Analysis** Initially, the absolute pressure in the tire is

$$P_1 = P_g + P_{atm} = 210 + 100 = 310 \text{ kPa}$$

Treating air as an ideal gas and assuming the volume of the tire to remain constant, the final pressure in the tire is determined from

$$\frac{P_1 V_1}{T_1} = \frac{P_2 V_2}{T_2} \longrightarrow P_2 = \frac{T_2}{T_1} P_1 = \frac{323 \text{ K}}{298 \text{ K}} (310 \text{ kPa}) = 336 \text{ kPa}$$

Thus the pressure rise is

$$\Delta P = P_2 - P_1 = 336 - 310 = \mathbf{26.0 \text{ kPa}}$$

The amount of air that needs to be bled off to restore pressure to its original value is

$$m_1 = \frac{P_1 V}{RT_1} = \frac{(310 \text{ kPa})(0.025 \text{ m}^3)}{(0.287 \text{ kPa} \cdot \text{m}^3/\text{kg} \cdot \text{K})(298 \text{ K})} = 0.0906 \text{ kg}$$

$$m_2 = \frac{P_2 V}{RT_2} = \frac{(310 \text{ kPa})(0.025 \text{ m}^3)}{(0.287 \text{ kPa} \cdot \text{m}^3/\text{kg} \cdot \text{K})(323 \text{ K})} = 0.0836 \text{ kg}$$

$$\Delta m = m_1 - m_2 = 0.0906 - 0.0836 = \mathbf{0.0070 \text{ kg}}$$

**Discussion** Notice that *absolute* rather than gage pressure must be used in calculations with the ideal gas law.

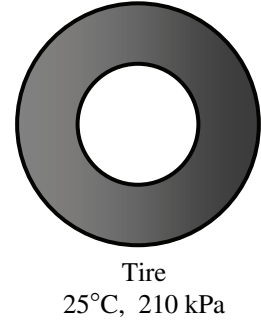

## 2-13

**Solution** A balloon is filled with helium gas. The number of moles and the mass of helium are to be determined.

**Assumptions** At specified conditions, helium behaves as an ideal gas.

**Properties** The molar mass of helium is 4.003 kg/kmol. The temperature of the helium gas is 20°C, which we must convert to absolute temperature for use in the equations:  $T = 20 + 273.15 = 293.15$  K. The universal gas constant is

$$R_u = 8.31447 \frac{\text{kJ}}{\text{kmol} \cdot \text{K}} \left( \frac{\text{kPa} \cdot \text{m}^3}{\text{kJ}} \right) = 8.31447 \frac{\text{kPa} \cdot \text{m}^3}{\text{kmol} \cdot \text{K}}.$$

**Analysis** The volume of the sphere is

$$\mathcal{V} = \frac{4}{3} \pi r^3 = \frac{4}{3} \pi (4.5 \text{ m})^3 = 381.704 \text{ m}^3$$

Assuming ideal gas behavior, the number of moles of He is determined from

$$N = \frac{P\mathcal{V}}{R_u T} = \frac{(200 \text{ kPa})(381.704 \text{ m}^3)}{(8.31447 \text{ kPa} \cdot \text{m}^3/\text{kmol} \cdot \text{K})(293.15 \text{ K})} = 31.321 \text{ kmol} \cong \mathbf{31.3 \text{ kmol}}$$

Then the mass of He is determined from

$$m = NM = (31.321 \text{ kmol})(4.003 \text{ kg/kmol}) = 125.38 \text{ kg} \cong \mathbf{125 \text{ kg}}$$

**Discussion** Although the helium mass may seem large (about the mass of an adult football player!), it is much smaller than that of the air it displaces, and that is why helium balloons rise in the air.

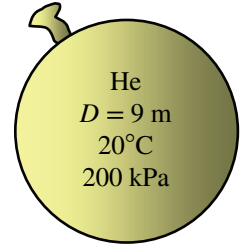

2-14 

**Solution** A balloon is filled with helium gas. The effect of the balloon diameter on the mass of helium is to be investigated, and the results are to be tabulated and plotted.

**Properties** The molar mass of helium is 4.003 kg/kmol. The temperature of the helium gas is 20°C, which we must convert to absolute temperature for use in the equations:  $T = 20 + 273.15 = 293.15$  K. The universal gas constant is

$$R_u = 8.31447 \frac{\text{kJ}}{\text{kmol} \cdot \text{K}} \left( \frac{\text{kPa} \cdot \text{m}^3}{\text{kJ}} \right) = 8.31447 \frac{\text{kPa} \cdot \text{m}^3}{\text{kmol} \cdot \text{K}}$$

**Analysis** The EES Equations window is shown below, followed by the two parametric tables and the plot (we overlaid the two cases to get them to appear on the same plot).

**"Spherical balloon mass"**

**"Given information:"**  
 "D = 9.0 [m]"  
 T = 20 + 273.15  
 P = 100 [kPa]  
 R\_u = 8.31447 [kPa\*m^3/(kmol\*K)]  
 M\_He = 4.003 [kg/kmol]

**"Equations:"**  
 Vol = pi\*(D^3)/6  
 P\*Vol = N\*R\_u\*T  
 m = N\*M\_He

**P = 100 kPa:**

D [m]	m [kg]
5.000	10.749
6.000	18.574
7.000	29.495
8.000	44.028
9.000	62.688
10.000	85.992
11.000	114.456
12.000	148.595
13.000	188.925
14.000	235.963
15.000	290.224

**P = 200 kPa:**

D [m]	m [kg]
5.000	21.498
6.000	37.149
7.000	58.991
8.000	88.056
9.000	125.377
10.000	171.985
11.000	228.912
12.000	297.190
13.000	377.850
14.000	471.926
15.000	580.448

D [m]	m [kg] (P = 100 kPa)	m [kg] (P = 200 kPa)
5	10.749	21.498
6	18.574	37.149
7	29.495	58.991
8	44.028	88.056
9	62.688	125.377
10	85.992	171.985
11	114.456	228.912
12	148.595	297.190
13	188.925	377.850
14	235.963	471.926
15	290.224	580.448

**Discussion** Mass increases with diameter as expected, but not linearly since volume is proportional to  $D^3$ .

2-8

**PROPRIETARY MATERIAL.** © 2018 McGraw-Hill Education. Limited distribution permitted only to teachers and educators for course preparation. If you are a student using this Manual, you are using it without permission.



## 2-15

**Solution** A cylindrical tank contains methanol at a specified mass and volume. The methanol's weight, density, and specific gravity and the force needed to accelerate the tank at a specified rate are to be determined.

**Assumptions** 1 The volume of the tank remains constant.

**Properties** The density of water is  $1000 \text{ kg/m}^3$ .

**Analysis** The methanol's weight, density, and specific gravity are

$$W = mg = 60 \text{ kg} \times 9.81 \frac{\text{m}}{\text{s}^2} = \mathbf{589 \text{ N}}$$

$$\rho = \frac{m}{V} = \frac{60 \text{ kg}}{75 \text{ L} \times \frac{1 \text{ m}^3}{1000 \text{ L}}} = \mathbf{800 \text{ kg/m}^3}$$

$$\text{SG} = \frac{\rho}{\rho_{\text{H}_2\text{O}}} = \frac{800 \text{ kg/m}^3}{1000 \text{ kg/m}^3} = \mathbf{0.800}$$

The force needed to accelerate the tank at the given rate is

$$F = ma = (60 \text{ kg}) \times \left(0.25 \frac{\text{m}}{\text{s}^2}\right) = \mathbf{15 \text{ N}}$$

---

## 2-16

**Solution** The cylinder conditions before the heat addition process is specified. The pressure after the heat addition process is to be determined.

**Assumptions** 1 The contents of cylinder are approximated by the air properties.

2 Air is an ideal gas.

**Analysis** The final pressure may be determined from the ideal gas relation

$$P_2 = \frac{T_2}{T_1} P_1 = \left( \frac{1500 + 273 \text{ K}}{450 + 273 \text{ K}} \right) (1800 \text{ kPa}) = \mathbf{4414 \text{ kPa}}$$

**Discussion** Note that some forms of the ideal gas equation are more convenient to use than the other forms.

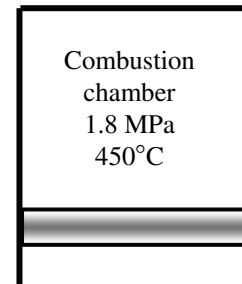

2-17



**Solution** A relation for the variation of density with elevation is to be obtained, the density at 7 km elevation is to be calculated, and the mass of the atmosphere using the correlation is to be estimated.

**Assumptions** 1 Atmospheric air behaves as an ideal gas. 2 The earth is perfectly spherical with a radius of 6377 km at sea level, and the thickness of the atmosphere is 25 km.

**Properties** The density data are given in tabular form as a function of radius and elevation, where  $r = z + 6377$  km:

$r$ , km	$z$ , km	$\rho$ , kg/m <sup>3</sup>
6377	0	1.225
6378	1	1.112
6379	2	1.007
6380	3	0.9093
6381	4	0.8194
6382	5	0.7364
6383	6	0.6601
6385	8	0.5258
6387	10	0.4135
6392	15	0.1948
6397	20	0.08891
6402	25	0.04008

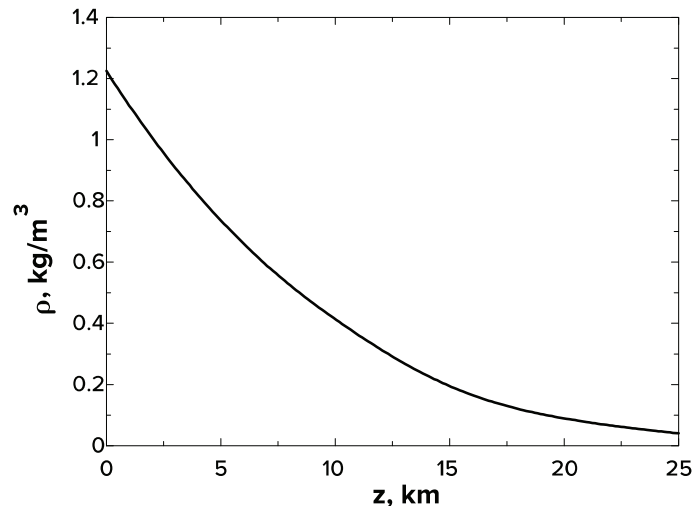

**Analysis** Using EES, (1) Define a trivial function “rho= a+z” in the Equation window, (2) select new parametric table from Tables, and type the data in a two-column table, (3) select Plot and plot the data, and (4) select Plot and click on curve fit to get curve fit window. Then specify 2<sup>nd</sup> order polynomial and enter/edit equation. The results are:

$$\rho(z) = a + bz + cz^2 = 1.20252 - 0.101674z + 0.0022375z^2 \text{ for the unit of kg/m}^3,$$

$$\text{(or, } \rho(z) = (1.20252 - 0.101674z + 0.0022375z^2) \times 10^9 \text{ for the unit of kg/km}^3\text{)}$$

where  $z$  is the vertical distance from the earth surface at sea level. At  $z = 7$  km, the equation gives  $\rho = 0.600 \text{ kg/m}^3$ .

(b) The mass of atmosphere is evaluated by integration to be

$$m = \int_V \rho dV = \int_{z=0}^h (a + bz + cz^2) 4\pi(r_0 + z)^2 dz = 4\pi \int_{z=0}^h (a + bz + cz^2)(r_0^2 + 2r_0z + z^2) dz$$

$$= 4\pi \left[ ar_0^2 h + r_0(2a + br_0)h^2 / 2 + (a + 2br_0 + cr_0^2)h^3 / 3 + (b + 2cr_0)h^4 / 4 + ch^5 / 5 \right]$$

where  $r_0 = 6377$  km is the radius of the earth,  $h = 25$  km is the thickness of the atmosphere. Also,  $a = 1.20252$ ,  $b = -0.101674$ , and  $c = 0.0022375$  are the constants in the density function. Substituting and multiplying by the factor  $10^9$  to convert the density from units of  $\text{kg/km}^3$  to  $\text{kg/m}^3$ , the mass of the atmosphere is determined to be approximately

$$m = 5.09 \times 10^{18} \text{ kg}$$

EES Solution for final result:

$$a = 1.2025166$$

$$b = -0.10167$$

$$c = 0.0022375$$

$$r = 6377$$

$$h = 25$$

$$m = 4 \cdot \pi \cdot (a \cdot r^2 \cdot h + r \cdot (2 \cdot a + b \cdot r) \cdot h^2 / 2 + (a + 2 \cdot b \cdot r + c \cdot r^2) \cdot h^3 / 3 + (b + 2 \cdot c \cdot r) \cdot h^4 / 4 + c \cdot h^5 / 5) \cdot 1E+9$$

**Discussion** At 7 km, the density of the air is approximately half of its value at sea level.

---

## 2-18

**Solution** Using the data for the density of R-134a in Table A-4, an expression for the density as a function of temperature in a specified form is to be obtained.

**Analysis** An Excel sheet gives the following results. Therefore we obtain

$$\rho(\text{kg/m}^3) = -0.037T^2 + 18.016T - 855.201, \quad T(\text{K})$$

Temp	Temp,K	Density	Rel. Error, %
-20	253	1359	-1.801766
-10	263	1327	-0.2446119
0	273	1295	0.8180695
10	283	1261	1.50943695
20	293	1226	1.71892333
30	303	1188	1.57525253
40	313	1147	1.04219704
50	323	1102	0.16279492
60	333	1053	-1.1173789
70	343	996.2	-2.502108
80	353	928.2	-3.693816
90	363	837.7	-3.4076638
100	373	651.7	10.0190272

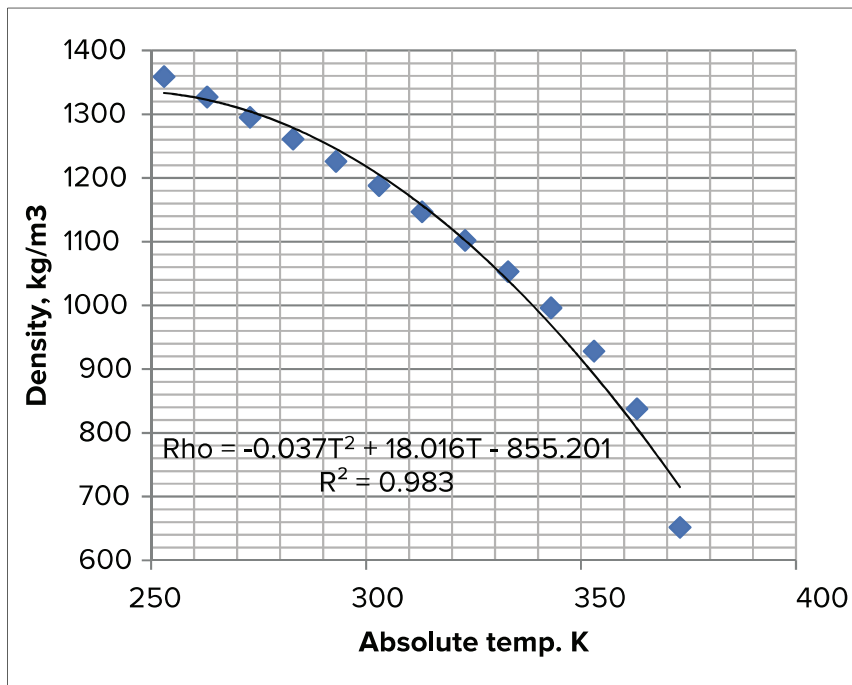

The relative accuracy is quite reasonable except the last data point.

## 2-19

**Solution** The difference between specific gravity and specific weight is to be explained and the specific weight of the substances in Table 2-1 are to be determined. Also, specific volume of a liquid is to be determined.

**Analysis** (a) *Specific gravity* is nondimensional, and is the ratio of the density of the fluid to the density of water at 4°C. *Specific weight* is dimensional, and is simply the product of the density of the fluid and the gravitational acceleration.

(b) Excel was used, and below is a printout from the spreadsheet.

To convert from *SG* to  $\gamma_s$ , we multiply by  $\rho_{\text{water}}$  and by  $g$ , where

$$\begin{aligned}\rho_{\text{water}} &= 1000 \text{ kg/m}^3 \\ g &= 9.807 \text{ m/s}^2\end{aligned}$$

Substance	SG	$\gamma_s$ (N/m <sup>3</sup> )
Water	1	9807
Blood	1.06	10395.42
Seawater	1.025	10052.175
Gasoline	0.68	6668.76
Ethyl alcohol	0.79	7747.53
Mercury	13.6	133375.2
Balsa wood	0.17	1667.19
Dense oak wood	0.93	9120.51
Gold	19.3	189275.1
Bones (low)	1.7	16671.9
Bones (high)	2	19614
Ice	0.916	8983.212
Air (at 1 atm)	0.001204	11.807628

(c) Specific volume is defined as  $v = 1/\rho$ . But  $\rho = SG \times \rho_{\text{water}}$ . Thus,

$$v = 1/(SG \times \rho_{\text{water}}) = 0.00168919 \text{ m}^3/\text{kg}$$

**Discussion** It is easy to confuse specific weight, specific gravity, and specific volume, so be careful with these terms. Excel shines in cases where there is a lot of repetition.

---

## Vapor Pressure and Cavitation

---

### 2-20C

**Solution** We are to define vapor pressure and discuss its relationship to saturation pressure.

**Analysis** The *vapor pressure*  $P_v$  of a pure substance is defined as **the pressure exerted by a vapor in phase equilibrium with its liquid at a given temperature**. In general, the pressure of a vapor or gas, whether it exists alone or in a mixture with other gases, is called the *partial pressure*. During phase change processes between the liquid and vapor phases of a pure substance, the **saturation pressure and the vapor pressure are equivalent** since the vapor is pure.

**Discussion** Partial pressure is not necessarily equal to vapor pressure. For example, on a dry day (low relative humidity), the partial pressure of water vapor in the air is less than the vapor pressure of water. If, however, the relative humidity is 100%, the partial pressure and the vapor pressure are equal.

---

---

### 2-21C

**Solution** We are to discuss whether the boiling temperature of water increases as pressure increases.

**Analysis** **Yes**. The saturation temperature of a pure substance depends on pressure; in fact, it *increases* with pressure. The higher the pressure, the higher the saturation or boiling temperature.

**Discussion** This fact is easily seen by looking at the saturated water property tables. Note that boiling temperature and saturation pressure at a given pressure are equivalent.

---

---

### 2-22C

**Solution** We are to determine if temperature increases or remains constant when the pressure of a boiling substance increases.

**Analysis** If the pressure of a substance increases during a boiling process, **the temperature also increases** since the boiling (or saturation) temperature of a pure substance depends on pressure and increases with it.

**Discussion** We are assuming that the liquid will continue to boil. If the pressure is increased fast enough, boiling may stop until the temperature has time to reach its new (higher) boiling temperature. A pressure cooker uses this principle.

---

---

**2-23C**

**Solution** We are to define and discuss cavitation.

**Analysis** In the flow of a liquid, *cavitation* is the **vaporization that may occur at locations where the pressure drops below the vapor pressure**. The vapor bubbles collapse as they are swept away from the low pressure regions, generating highly destructive, extremely high-pressure waves. This phenomenon is a common cause for drop in performance and even the erosion of impeller blades.

**Discussion** The word “cavitation” comes from the fact that a vapor bubble or “cavity” appears in the liquid. Not all cavitation is undesirable. It turns out that some underwater vehicles employ “super cavitation” on purpose to reduce drag.

---

**2-24E**

**Solution** The minimum pressure on the suction side of a water pump is given. The maximum water temperature to avoid the danger of cavitation is to be determined.

**Properties** The saturation temperature of water at 0.70 psia is 90°F (Table A-3E).

**Analysis** To avoid cavitation at a specified pressure, the fluid temperature everywhere in the flow should remain below the saturation temperature at the given pressure, which is

$$T_{\max} = T_{\text{sat @ 0.70 psia}} = \mathbf{90^{\circ}\text{F}}$$

Therefore, ***T* must remain below 90°F to avoid the possibility of cavitation.**

**Discussion** Note that saturation temperature increases with pressure, and thus cavitation may occur at higher pressure at locations with higher fluid temperatures.

---

**2-25**

**Solution** The minimum pressure in a pump to avoid cavitation is to be determined.

**Properties** The vapor pressure of water at 20°C is 2.339 kPa.

**Analysis** To avoid cavitation, the pressure anywhere in the system should not be allowed to drop below the vapor (or saturation) pressure at the given temperature. That is,

$$P_{\min} = P_{\text{sat@20}^{\circ}\text{C}} = \mathbf{2.339\text{ kPa}}$$

Therefore, **the lowest pressure that can exist in the pump is 2.339 kPa.**

**Discussion** Note that the vapor pressure increases with increasing temperature, and thus the risk of cavitation is greater at higher fluid temperatures.

---

**2-26**

**Solution** The minimum pressure in a piping system to avoid cavitation is to be determined.

**Properties** The vapor pressure of water at 30°C is 4.246 kPa.

**Analysis** To avoid cavitation, the pressure anywhere in the flow should not be allowed to drop below the vapor (or saturation) pressure at the given temperature. That is,

$$P_{\min} = P_{\text{sat}@30^\circ\text{C}} = \mathbf{4.246 \text{ kPa}}$$

Therefore, the pressure should be maintained above 4.246 kPa everywhere in flow.

**Discussion** Note that the vapor pressure increases with increasing temperature, and thus the risk of cavitation is greater at higher fluid temperatures.

---



---

**Energy and Specific Heats**

---

**2-27C**

**Solution** We are to define total energy and identify its constituents.

**Analysis** The **sum of all forms of the energy a system possesses** is called *total energy*. In the absence of magnetic, electrical, and surface tension effects, **the total energy of a system consists of the kinetic, potential, and internal energies**.

**Discussion** All three constituents of total energy (kinetic, potential, and internal) need to be considered in an analysis of a general fluid flow.

---

---

**2-28C**

**Solution** We are to list the forms of energy that contribute to the internal energy of a system.

**Analysis** The *internal energy* of a system is made up of **sensible, latent, chemical, and nuclear energies**. The sensible internal energy is due to translational, rotational, and vibrational effects.

**Discussion** We deal with the flow of a single phase fluid in most problems in this textbook; therefore, latent, chemical, and nuclear energies do not need to be considered.

---

---

**2-29C**

**Solution** We are to discuss the relationship between heat, internal energy, and thermal energy.

**Analysis** *Thermal energy* is the **sensible and latent forms of internal energy**. It does not include chemical or nuclear forms of energy. In common terminology, thermal energy is referred to as *heat*. However, like work, heat is not a property, whereas thermal energy is a property.

**Discussion** Technically speaking, “heat” is defined only when there is *heat transfer*, whereas the energy state of a substance can always be defined, even if no heat transfer is taking place.

---

---

## 2-30C

**Solution** We are to define and discuss flow energy.

**Analysis** *Flow energy* or *flow work* is the **energy needed to push a fluid into or out of a control volume**. Fluids at rest do not possess any flow energy.

**Discussion** Flow energy is not a fundamental quantity, like kinetic or potential energy. However, it is a useful concept in fluid mechanics since fluids are often forced into and out of control volumes in practice.

---

## 2-31C

**Solution** We are to compare the energies of flowing and non-flowing fluids.

**Analysis** A **flowing fluid possesses flow energy, which is the energy needed to push a fluid into or out of a control volume**, in addition to the forms of energy possessed by a non-flowing fluid. The total energy of a non-flowing fluid consists of internal and potential energies. If the fluid is moving as a rigid body, but not *flowing*, it may also have kinetic energy (e.g., gasoline in a tank truck moving down the highway at constant speed with no sloshing). The total energy of a flowing fluid consists of internal, kinetic, potential, *and* flow energies.

**Discussion** Flow energy is not to be confused with kinetic energy, even though both are zero when the fluid is at rest.

---

## 2-32C

**Solution** We are to explain how changes in internal energy can be determined.

**Analysis** Using specific heat values at the average temperature, the changes in the specific internal energy of ideal gases can be determined from  $\Delta u = c_{v,avg} \Delta T$ . For incompressible substances,  $c_p \cong c_v \cong c$  and  $\Delta u = c_{avg} \Delta T$ .

**Discussion** If the fluid can be treated as neither incompressible nor an ideal gas, property tables must be used.

---

## 2-33C

**Solution** We are to explain how changes in enthalpy can be determined.

**Analysis** Using specific heat values at the average temperature, the changes in specific enthalpy of ideal gases can be determined from  $\Delta h = c_{p,avg} \Delta T$ . For incompressible substances,  $c_p \cong c_v \cong c$  and  $\Delta h = \Delta u + v \Delta P \cong c_{avg} \Delta T + v \Delta P$ .

**Discussion** If the fluid can be treated as neither incompressible nor an ideal gas, property tables must be used.

---

## 2-34E

**Solution** We are to estimate the energy required to heat up the water in a hot-water tank.

**Assumptions** **1** There are no losses. **2** The pressure in the tank remains constant at 1 atm. **3** An approximate analysis is performed by replacing differential changes in quantities by finite changes.

**Properties** The specific heat of water is approximated as a constant, whose value is 0.999 Btu/lbm·R at the average temperature of  $(60 + 110)/2 = 85^\circ\text{F}$ . In fact,  $c$  remains constant at 0.999 Btu/lbm·R (to three digits) from  $60^\circ\text{F}$  to  $110^\circ\text{F}$ . For this same temperature range, the density varies from 62.36 lbm/ft<sup>3</sup> at  $60^\circ\text{F}$  to 61.86 lbm/ft<sup>3</sup> at  $110^\circ\text{F}$ . We approximate the density as constant, whose value is 62.17 lbm/ft<sup>3</sup> at the average temperature of  $85^\circ\text{F}$ .

**Analysis** For a constant pressure process,  $\Delta u \cong c_{\text{avg}}\Delta T$ . Since this is energy per unit mass, we must multiply by the total mass of the water in the tank, i.e.,  $\Delta U \cong mc_{\text{avg}}\Delta T = \rho V c_{\text{avg}}\Delta T$ . Thus,

$$\Delta U \cong \rho V c_{\text{avg}}\Delta T = (62.17 \text{ lbm/ft}^3)(75 \text{ gal})(0.999 \text{ Btu/lbm}\cdot\text{R})[(110 - 60)\text{R}] \left( \frac{35.315 \text{ ft}^3}{264.17 \text{ gal}} \right) = 31,135 \text{ Btu} \cong \mathbf{31,100 \text{ Btu}}$$

where we note temperature *differences* are identical in °F and R.

**Discussion** We give the final answer to 3 significant digits. The actual energy required will be greater than this, due to heat transfer losses and other inefficiencies in the hot-water heating system.

---

## 2-35

**Solution** The total energy of saturated water vapor flowing in a pipe at a specified velocity and elevation is to be determined.

**Analysis** The total energy of a flowing fluid is given by (Eq. 2-8)

$$e = h + \frac{V^2}{2} + gz$$

The enthalpy of the vapor at the specified temperature can be found in any thermo text to be 2745.9 kJ/kg. Then the total energy is determined as

$$e = 2745.9 \times 10^3 \frac{\text{J}}{\text{kg}} + \frac{\left(35 \frac{\text{m}}{\text{s}}\right)^2}{2} + \left(9.81 \frac{\text{m}}{\text{s}^2}\right) \times (25 \text{ m}) \cong 2.7468 \times 10^6 \frac{\text{J}}{\text{kg}} = 2746.8 \text{ kJ/kg}$$

Note that only 0.031% of the total energy comes from the combination of kinetic and potential energies, which explains why we usually neglect kinetic and potential energies in most flow systems.

---

---

**Compressibility**

---

**2-36C**

**Solution** We are to define the coefficient of volume expansion.

**Analysis** The *coefficient of volume expansion* represents the **variation of the density of a fluid with temperature at constant pressure**. It differs from the coefficient of compressibility in that the latter represents the variation of *pressure* of a fluid with density at constant temperature.

**Discussion** The coefficient of volume expansion of an ideal gas is equal to the inverse of its absolute temperature.

---

---

**2-37C**

**Solution** We are to discuss the coefficient of compressibility and the isothermal compressibility.

**Analysis** The *coefficient of compressibility* represents the **variation of pressure of a fluid with volume or density at constant temperature**. *Isothermal compressibility* is the inverse of the coefficient of compressibility, and it represents the **fractional change in volume or density corresponding to a change in pressure**.

**Discussion** The coefficient of compressibility of an ideal gas is equal to its absolute pressure.

---

---

**2-38C**

**Solution** We are to discuss the sign of the coefficient of compressibility and the coefficient of volume expansion.

**Analysis** The *coefficient of compressibility* of a fluid **cannot be negative**, but the *coefficient of volume expansion* **can be negative** (e.g., liquid water below 4°C).

**Discussion** This is the reason that ice floats on water.

---

---

## 2-39E

**Solution** We are to estimate the density as water is heated, and we are to compare to the actual density.

**Assumptions** **1** The coefficient of volume expansion is constant in the given temperature range. **2** The pressure remains constant at 1 atm throughout the heating process. **3** An approximate analysis is performed by replacing differential changes in quantities by finite changes.

**Properties** The density of water at 60°F and 1 atm pressure is  $\rho_1 = 62.36 \text{ lbm/ft}^3$ . The coefficient of volume expansion at the average temperature of  $(60 + 130)/2 = 95^\circ\text{F}$  is  $\beta = 0.187 \times 10^{-3} \text{ R}^{-1}$ .

**Analysis** The change in density due to the change of temperature from 60°F to 130°F at constant pressure is

$$\Delta\rho \cong -\beta\rho\Delta T = -\left(0.187 \times 10^{-3} \frac{1}{\text{R}}\right)\left(62.36 \frac{\text{lbm}}{\text{ft}^3}\right)\left[(130 - 60) \text{ R}\right] = -0.816 \frac{\text{lbm}}{\text{ft}^3}$$

where we note temperature *differences* are identical in °F and R. Thus, the density at the higher temperature is approximated as  $\rho_2 \approx \rho_1 + \Delta\rho = 62.36 - 0.816 = \mathbf{61.54 \text{ lbm/ft}^3}$ . From the appendices, we see that the *actual* density at 130°F is  $\mathbf{61.55 \text{ lbm/ft}^3}$ . Thus, the approximation is extremely good, with an error of less than 0.02%.

**Discussion** Note that the density of water decreases while being heated, as expected. This problem can be solved more accurately using differential analysis when functional forms of properties are available.

---

## 2-40

**Solution** The volume of an ideal gas is reduced by half at constant temperature. The change in pressure is to be determined.

**Assumptions** The process is isothermal and thus the temperature remains constant.

**Analysis** For an ideal gas of fixed mass undergoing an isothermal process, the ideal gas relation reduces to

$$\frac{P_2 V_2}{T_2} = \frac{P_1 V_1}{T_1} \quad \rightarrow \quad P_2 V_2 = P_1 V_1 \quad \rightarrow \quad P_2 = \frac{V_1}{V_2} P_1 = \frac{V_1}{0.5V_1} P_1 = 2P_1$$

Therefore, the change in pressure becomes

$$\Delta P = P_2 - P_1 = 2P_1 - P_1 = \mathbf{P_1}$$

**Discussion** Note that at constant temperature, pressure and volume of an ideal gas are inversely proportional.

---

## 2-41

**Solution** Water at a given temperature and pressure is compressed to a high pressure isothermally. The increase in the density of water is to be determined.

**Assumptions** 1 The isothermal compressibility is constant in the given pressure range. 2 An approximate analysis is performed by replacing differential changes by finite changes.

**Properties** The density of water at 20°C and 1 atm pressure is  $\rho_1 = 998 \text{ kg/m}^3$ . The isothermal compressibility of water is given to be  $\alpha = 4.80 \times 10^{-5} \text{ atm}^{-1}$ .

**Analysis** When differential quantities are replaced by differences and the properties  $\alpha$  and  $\beta$  are assumed to be constant, the change in density in terms of the changes in pressure and temperature is expressed approximately as

$$\Delta\rho = \alpha\rho\Delta P - \beta\rho\Delta T$$

The change in density due to a change of pressure from 1 atm to 400 atm at constant temperature is

$$\Delta\rho = \alpha\rho\Delta P = (4.80 \times 10^{-5} \text{ atm}^{-1})(998 \text{ kg/m}^3)(400 - 1)\text{atm} = \mathbf{19.2 \text{ kg/m}^3}$$

**Discussion** Note that the density of water increases from 998 to 1017.2 kg/m<sup>3</sup> while being compressed, as expected. This problem can be solved more accurately using differential analysis when functional forms of properties are available.

---

## 2-42

**Solution** The percent increase in the density of an ideal gas is given for a moderate pressure. The percent increase in density of the gas when compressed at a higher pressure is to be determined.

**Assumptions** The gas behaves an ideal gas.

**Analysis** For an ideal gas,  $P = \rho RT$  and  $(\partial P / \partial \rho)_T = RT = P / \rho$ , and thus  $\kappa_{\text{ideal gas}} = P$ . Therefore, the coefficient of compressibility of an ideal gas is equal to its absolute pressure, and the coefficient of compressibility of the gas increases with increasing pressure.

Substituting  $\kappa = P$  into the definition of the coefficient of compressibility  $\kappa \cong -\frac{\Delta P}{\Delta \nu / \nu} \cong \frac{\Delta P}{\Delta \rho / \rho}$  and rearranging gives

$$\frac{\Delta \rho}{\rho} = \frac{\Delta P}{P}$$

Therefore, **the percent increase of density of an ideal gas during isothermal compression is equal to the percent increase in pressure.**

$$\text{At 10 atm: } \frac{\Delta \rho}{\rho} = \frac{\Delta P}{P} = \frac{11-10}{10} = 0.10 = 10\%$$

$$\text{At 1000 atm: } \frac{\Delta \rho}{\rho} = \frac{\Delta P}{P} = \frac{101-100}{100} = 0.01 = 1\%$$

Therefore, a pressure change of 1 atm causes a density change of 10% at 10 atm and a density change of 1% at 1000 atm.

**Discussion** If temperature were also allowed to change, the relationship would not be so simple.

---

## 2-43

**Solution** Saturated refrigerant-134a at a given temperature is cooled at constant pressure. The change in the density of the refrigerant is to be determined.

**Assumptions** 1 The coefficient of volume expansion is constant in the given temperature range. 2 An approximate analysis is performed by replacing differential changes in quantities by finite changes.

**Properties** The density of saturated liquid R-134a at 10°C is  $\rho_1 = 1261 \text{ kg/m}^3$ . The coefficient of volume expansion at the average temperature of  $(10+0)/2 = 5^\circ\text{C}$  is  $\beta = 0.00269 \text{ K}^{-1}$ .

**Analysis** When differential quantities are replaced by differences and the properties  $\alpha$  and  $\beta$  are assumed to be constant, the change in density in terms of the changes in pressure and temperature is expressed approximately as

$$\Delta\rho = \alpha\rho\Delta P - \beta\rho\Delta T$$

The change in density due to the change of temperature from 10°C to 0°C at constant pressure is

$$\Delta\rho = -\beta\rho\Delta T = -(0.00269 \text{ K}^{-1})(1261 \text{ kg/m}^3)(0 - 10)\text{K} = \mathbf{33.9 \text{ kg/m}^3}$$

**Discussion** Noting that  $\Delta\rho = \rho_2 - \rho_1$ , the density of R-134a at 0°C is

$$\rho_2 = \rho_1 + \Delta\rho = 1261 + 33.9 = 1294.9 \text{ kg/m}^3$$

which is almost identical to the listed value of 1295 kg/m<sup>3</sup> at 0°C in R-134a table in the Appendix. This is mostly due to  $\beta$  varying with temperature almost linearly. Note that the density increases during cooling, as expected.

---



## 2-44

**Solution** A water tank completely filled with water can withstand tension caused by a volume expansion of 0.8%. The maximum temperature rise allowed in the tank without jeopardizing safety is to be determined.

**Assumptions** **1** The coefficient of volume expansion is constant. **2** An approximate analysis is performed by replacing differential changes in quantities by finite changes. **3** The effect of pressure is disregarded.

**Properties** The average volume expansion coefficient is given to be  $\beta = 0.377 \times 10^{-3} \text{ K}^{-1}$  (Table A-3 at 40°C).

**Analysis** When differential quantities are replaced by differences and the properties  $\alpha$  and  $\beta$  are assumed to be constant, the change in density in terms of the changes in pressure and temperature is expressed approximately as

$$\Delta\rho = \alpha\rho\Delta P - \beta\rho\Delta T$$

A volume increase of 0.8% corresponds to a density decrease of 0.8%, which can be expressed as  $\Delta\rho = -0.008\rho$ . Then the decrease in density due to a temperature rise of  $\Delta T$  at constant pressure is

$$-0.008\rho = -\beta\rho\Delta T$$

Solving for  $\Delta T$  and substituting, the maximum temperature rise is determined to be

$$\Delta T = \frac{0.008}{\beta} = \frac{0.008}{0.377 \times 10^{-3} \text{ K}^{-1}} = \mathbf{21.2 \text{ K} = 21.2^\circ\text{C}}$$

**Discussion** This result is conservative since in reality the increasing pressure will tend to compress the water and increase its density.

---

## 2-45

**Solution** A water tank completely filled with water can withstand tension caused by a volume expansion of 0.4%. The maximum temperature rise allowed in the tank without jeopardizing safety is to be determined.

**Assumptions** **1** The coefficient of volume expansion is constant. **2** An approximate analysis is performed by replacing differential changes in quantities by finite changes. **3** The effect of pressure is disregarded.

**Properties** The average volume expansion coefficient is given to be  $\beta = 0.377 \times 10^{-3} \text{ K}^{-1}$  (Table A-3 at  $40^\circ\text{C}$ ).

**Analysis** When differential quantities are replaced by differences and the properties  $\alpha$  and  $\beta$  are assumed to be constant, the change in density in terms of the changes in pressure and temperature is expressed approximately as

$$\Delta\rho = \alpha\rho\Delta P - \beta\rho\Delta T$$

A volume increase of 0.4% corresponds to a density decrease of 0.4%, which can be expressed as  $\Delta\rho = -0.004\rho$ . Then the decrease in density due to a temperature rise of  $\Delta T$  at constant pressure is

$$-0.004\rho = -\beta\rho\Delta T$$

Solving for  $\Delta T$  and substituting, the maximum temperature rise is determined to be

$$\Delta T = \frac{0.004}{\beta} = \frac{0.004}{0.377 \times 10^{-3} \text{ K}^{-1}} = \mathbf{10.6 \text{ K} = 10.6^\circ\text{C}}$$

**Discussion** This result is conservative since in reality the increasing pressure will tend to compress the water and increase its density. The change in temperature is exactly half of that of the previous problem, as expected.

---

## 2-46

**Solution** The density of seawater at the free surface and the bulk modulus of elasticity are given. The density and pressure at a depth of 2500 m are to be determined.

**Assumptions** 1 The temperature and the bulk modulus of elasticity of seawater is constant. 2 The gravitational acceleration remains constant.

**Properties** The density of seawater at free surface where the pressure is given to be  $1030 \text{ kg/m}^3$ , and the bulk modulus of elasticity of seawater is given to be  $2.34 \times 10^9 \text{ N/m}^2$ .

**Analysis** The coefficient of compressibility or the bulk modulus of elasticity of fluids is expressed as

$$\kappa = \rho \left( \frac{\partial P}{\partial \rho} \right)_T \quad \text{or} \quad \kappa = \rho \frac{dP}{d\rho} \quad (\text{at constant } T)$$

The differential pressure change across a differential fluid height of  $dz$  is given as

$$dP = \rho g dz$$

Combining the two relations above and rearranging,

$$\kappa = \rho \frac{\rho g dz}{d\rho} = g \rho^2 \frac{dz}{d\rho} \quad \rightarrow \quad \frac{d\rho}{\rho^2} = \frac{g dz}{\kappa}$$

Integrating from  $z = 0$  where  $\rho = \rho_0 = 1030 \text{ kg/m}^3$  to  $z = z$  where  $\rho = \rho$  gives

$$\int_{\rho_0}^{\rho} \frac{d\rho}{\rho^2} = \frac{g}{\kappa} \int_0^z dz \quad \rightarrow \quad \frac{1}{\rho_0} - \frac{1}{\rho} = \frac{gz}{\kappa}$$

Solving for  $\rho$  gives the variation of density with depth as

$$\rho = \frac{1}{(1/\rho_0) - (gz/\kappa)}$$

Substituting into the pressure change relation  $dP = \rho g dz$  and integrating from  $z = 0$  where  $P = P_0 = 98 \text{ kPa}$  to  $z = z$  where  $P = P$  gives

$$\int_{P_0}^P dP = \int_0^z \frac{g dz}{(1/\rho_0) - (gz/\kappa)} \quad \rightarrow \quad P = P_0 + \kappa \ln \left( \frac{1}{1 - (\rho_0 g z / \kappa)} \right)$$

which is the desired relation for the variation of pressure in seawater with depth. At  $z = 2500 \text{ m}$ , the values of density and pressure are determined by substitution to be

$$\begin{aligned} \rho &= \frac{1}{1/(1030 \text{ kg/m}^3) - (9.81 \text{ m/s}^2)(2500 \text{ m})/(2.34 \times 10^9 \text{ N/m}^2)} = \mathbf{1041 \text{ kg/m}^3} \\ P &= (98,000 \text{ Pa}) + (2.34 \times 10^9 \text{ N/m}^2) \ln \left( \frac{1}{1 - (1030 \text{ kg/m}^3)(9.81 \text{ m/s}^2)(2500 \text{ m})/(2.34 \times 10^9 \text{ N/m}^2)} \right) \\ &= 2.550 \times 10^7 \text{ Pa} \\ &= \mathbf{25.50 \text{ MPa}} \end{aligned}$$

since  $1 \text{ Pa} = 1 \text{ N/m}^2 = 1 \text{ kg/m} \cdot \text{s}^2$  and  $1 \text{ kPa} = 1000 \text{ Pa}$ .

**Discussion** Note that if we assumed  $\rho = \rho_0 = \text{constant}$  at  $1030 \text{ kg/m}^3$ , the pressure at 2500 m would be  $P = P_0 + \rho g z = 0.098 + 25.26 = 25.36 \text{ MPa}$ . Then the density at 2500 m is estimated to be

$$\Delta \rho = \rho \alpha \Delta P = (1030)(2340 \text{ MPa})^{-1}(25.26 \text{ MPa}) = 11.1 \text{ kg/m}^3 \text{ and thus } \rho = 1041 \text{ kg/m}^3$$

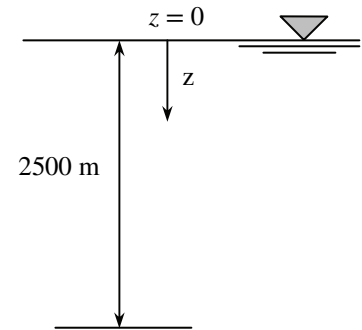

## 2-47E

**Solution** The coefficient of compressibility of water is given. The pressure increases required to reduce the volume of water by 1 percent and then by 2 percent are to be determined.

**Assumptions** 1 The coefficient of compressibility is constant. 2 The temperature remains constant.

**Properties** The coefficient of compressibility of water is given to be  $7 \times 10^5$  psia.

**Analysis** (a) A volume decrease of 1 percent can mathematically be expressed as

$$\frac{\Delta \nu}{\nu} = \frac{\Delta \nu}{\nu} = -0.01$$

The coefficient of compressibility is expressed as

$$\kappa = -\nu \left( \frac{\partial P}{\partial \nu} \right)_T \cong -\frac{\Delta P}{\Delta \nu / \nu}$$

Rearranging and substituting, the required pressure increase is determined to be

$$\Delta P = -\kappa \left( \frac{\Delta \nu}{\nu} \right) = -(7 \times 10^5 \text{ psia})(-0.01) = 7,000 \text{ psia}$$

(b) Similarly, the required pressure increase for a volume reduction of 2 percent becomes

$$\Delta P = -\kappa \left( \frac{\Delta \nu}{\nu} \right) = -(7 \times 10^5 \text{ psia})(-0.02) = 14,000 \text{ psia}$$

**Discussion** Note that at extremely high pressures are required to compress water to an appreciable amount.

---

2-48

**Solution** The water contained in a piston-cylinder device is compressed isothermally. The energy needed is to be determined.

**Assumptions** 1 The coefficient of compressibility of water remains unchanged during the compression.

**Analysis** We take the water in the cylinder as the system. The energy needed to compress water is equal to the work done on the system, and can be expressed as

$$W = - \int_1^2 P dV \quad (1)$$

From the definition of coefficient of compressibility we have

$$\kappa = - \frac{dP}{dV/V}$$

Rearranging we obtain

$$\frac{dV}{V} = - \frac{dP}{\kappa}$$

which can be integrated from the initial state to any state as follows:

$$\int_{V_0}^V \frac{dV}{V} = - \int_{P_0}^P \frac{dP}{\kappa} \rightarrow \ln \frac{V}{V_0} = - \frac{P - P_0}{\kappa}$$

from which we obtain

$$P = P_0 - \kappa \ln \frac{V}{V_0}$$

Substituting in Eq. 1 we have

$$W = - \int_{V_0}^{V_1} P dV = - \int_{V_0}^{V_1} \left( P_0 - \kappa \ln \frac{V}{V_0} \right) dV = \left[ \kappa V \ln \frac{V}{V_0} - (P_0 + \kappa) V \right]_{V_0}^{V_1}$$

or

$$W = (P_0 + \kappa)(V_0 - V_1) + \kappa V_0 \ln \frac{V_1}{V_0}$$

In terms of finite changes, the fractional change due to change in pressure can be expressed approximately as

$$\frac{V_1 - V_0}{V_0} \cong -\alpha(P_1 - P_0)$$

or

$$V_1 \cong V_0 (1 - \alpha(P_1 - P_0))$$

where  $\alpha$  is the isothermal compressibility of water, which is at  $4.80 \times 10^{-5} \text{ atm}^{-1}$  at  $20^\circ\text{C}$ . Realizing that 10 kg water occupies initially a volume of  $V_0 = 10 \times 10^{-3} \text{ m}^3$ , the final volume of water is determined to be

$$V_1 \cong (0.01 \text{ m}^3) \times [1 - (4.80 \times 10^{-5} \text{ atm}^{-1}) \times (100 \text{ atm} - 1 \text{ atm})] = 9.952 \times 10^{-3} \text{ m}^3$$

Then the work done on the water is

$$W = (1 \text{ atm} + 2100 \text{ atm}) \times (10 \times 10^{-3} \text{ m}^3 - 9.952 \times 10^{-3} \text{ m}^3) \\ + 2100 \text{ atm} \times (10 \times 10^{-3} \text{ m}^3) \ln \frac{9.952 \times 10^{-3} \text{ m}^3}{10 \times 10^{-3} \text{ m}^3}$$

from which we obtain

$$W = 2.903 \times 10^{-4} \text{ atm} \cdot \text{m}^3 \cong \mathbf{29.4 \text{ J}}$$

since  $1 \text{ atm} = 101325 \text{ Pa}$ .

## 2-49

**Solution** The water contained in a piston-cylinder device is compressed isothermally and the pressure increases linearly. The energy needed is to be determined.

**Assumptions** 1 The pressure increases linearly.

**Analysis** We take the water in the cylinder as the system. The energy needed to compress water is equal to the work done on the system, and can be expressed as

$$W = - \int_1^2 P dV \quad (1)$$

For a linear pressure increase we take

$$P = P_{\text{ave}} = \frac{P_1 + P_2}{2} = \frac{100 \text{ atm} + 1 \text{ atm}}{2} = 50.5 \text{ atm}$$

In terms of finite changes, the fractional change due to change in pressure can be expressed approximately as (Eq. 3–23)

$$\frac{V_1 - V_0}{V_0} \cong -\alpha(P_1 - P_0)$$

or

$$V_1 \cong V_0(1 - \alpha(P_1 - P_0))$$

where  $\alpha$  is the isothermal compressibility of water, which is at  $4.80 \times 10^{-5} \text{ atm}^{-1}$  at  $20^\circ\text{C}$ . Realizing that 10 kg water occupies initially a volume of  $V_0 = 10 \times 10^{-3} \text{ m}^3$ , the final volume of water is determined to be

$$V_1 \cong (0.01 \text{ m}^3) \times [1 - (4.80 \times 10^{-5} \text{ atm}^{-1}) \times (100 \text{ atm} - 1 \text{ atm})] = 9.952 \times 10^{-3} \text{ m}^3$$

Therefore the work expression becomes

$$W = - \int_{V_0}^{V_1} P dV = -P_{\text{ave}}(V_1 - V_0) = -(50.5 \text{ atm}) \times (9.952 \times 10^{-3} \text{ m}^3 - 10 \times 10^{-3} \text{ m}^3)$$

or

$$W = 2.424 \times 10^{-3} \text{ atm} \cdot \text{m}^3 = \mathbf{246 \text{ J}}$$

Thus, we conclude that linear pressure increase approximation does not work well since it gives almost ten times larger work.

---

## 2-50

**Solution** We are to estimate the density of air at two temperatures using the Boussinesq approximation, and we are to compare to the actual density at those temperatures.

**Assumptions** **1** The coefficient of volume expansion is constant in the given temperature range. **2** The pressure remains constant at 95.0 kPa throughout the flow field. **3** Air is taken as an ideal gas.

**Properties** The reference density of air at  $T_0 = 40^\circ\text{C}$  (313.15 K) and  $P = 95.0$  kPa is

$$\rho_0 = \frac{P}{RT_0} = \frac{95.0 \text{ kPa}}{(0.2870 \text{ kJ/kg}\cdot\text{K})(313.15\text{K})} \left( \frac{\text{kJ}}{\text{kN}\cdot\text{m}} \right) \left( \frac{\text{kN/m}^2}{\text{kPa}} \right) = 1.05703 \text{ kg/m}^3$$

where we have kept 6 significant digits to avoid round-off error in subsequent calculations. The coefficient of volume expansion at  $T_0 = 40^\circ\text{C}$  (313.15 K) is  $\beta = 1/T_0 = 3.1934 \times 10^{-3} \text{ K}^{-1}$ .

**Analysis** Using the Boussinesq approximation at  $T = 20^\circ\text{C}$ , we calculate

*Boussinesq density at 20°C:*

$$\begin{aligned} \rho_{20} &= \rho_0 [1 - \beta(T - T_0)] \\ &= (1.05703 \text{ kg/m}^3) \left[ 1 - (3.1934 \times 10^{-3} \text{ K}^{-1})(20 - 40) \text{ K} \right] = 1.1245 \text{ kg/m}^3 \cong \mathbf{1.12 \text{ kg/m}^3} \end{aligned}$$

where we note temperature *differences* are identical in °C and K. Similarly, at  $T = 60^\circ\text{C}$ ,

*Boussinesq density at 60°C:*

$$\begin{aligned} \rho_{60} &= \rho_0 [1 - \beta(T - T_0)] \\ &= (1.05703 \text{ kg/m}^3) \left[ 1 - (3.1934 \times 10^{-3} \text{ K}^{-1})(60 - 40) \text{ K} \right] = 0.98953 \text{ kg/m}^3 \cong \mathbf{0.990 \text{ kg/m}^3} \end{aligned}$$

The *actual* values of density are obtained from the ideal gas law, yielding  $\rho_{20, \text{actual}} = 1.1292 \text{ kg/m}^3 \approx \mathbf{1.13 \text{ kg/m}^3}$ ; the Boussinesq approximation has a percentage error of **-0.41%**. Similarly,  $\rho_{60, \text{actual}} = 0.99358 \text{ kg/m}^3 \approx \mathbf{0.994 \text{ kg/m}^3}$ ; the Boussinesq approximation has a percentage error of **-0.41%**. Thus, the Boussinesq approximation is extremely good for this range of temperature.

**Discussion** In the calculation of percentage error, we used five digits of precision to avoid round-off error. Note that the density of air decreases when heated, as expected (hot air rises). The Boussinesq approximation is often used in computational fluid dynamics (CFD).

## 2-51

**Solution** Using the definition of the coefficient of volume expansion and the expression  $\beta_{\text{ideal gas}} = 1/T$ , it is to be shown that the percent increase in the specific volume of an ideal gas during isobaric expansion is equal to the percent increase in absolute temperature.

**Assumptions** The gas behaves as an ideal gas.

**Analysis** The coefficient of volume expansion  $\beta$  can be expressed as  $\beta = \frac{1}{\nu} \left( \frac{\partial \nu}{\partial T} \right)_P \approx \frac{\Delta \nu / \nu}{\Delta T}$ .

Noting that  $\beta_{\text{ideal gas}} = 1/T$  for an ideal gas and rearranging give

$$\frac{\Delta \nu}{\nu} = \frac{\Delta T}{T}$$

Therefore, **the percent increase in the specific volume of an ideal gas during isobaric expansion is equal to the percent increase in absolute temperature.**

**Discussion** We must be careful to use *absolute* temperature (K or R), not relative temperature ( $^{\circ}\text{C}$  or  $^{\circ}\text{F}$ ).

---



---

**Speed of Sound**

---

**2-52C**

**Solution** We are to define and discuss sound and how it is generated and how it travels.

**Analysis** *Sound* is an **infinitesimally small pressure wave**. It is **generated by a small disturbance in a medium**. It **travels by wave propagation**. **Sound waves cannot travel in a vacuum**.

**Discussion** Electromagnetic waves, like light and radio waves, can travel in a vacuum, but sound cannot.

---

**2-53C**

**Solution** We are to discuss whether sound travels faster in warm or cool air.

**Analysis** Sound travels faster in **warm (higher temperature) air** since  $c = \sqrt{kRT}$ .

**Discussion** On the microscopic scale, we can imagine the air molecules moving around at higher speed in warmer air, leading to higher propagation of disturbances.

---

**2-54C**

**Solution** We are to compare the speed of sound in air, helium, and argon.

**Analysis** **Sound travels fastest in helium**, since  $c = \sqrt{kRT}$  and helium has the highest  $kR$  value. It is about 0.40 for air, 0.35 for argon, and 3.46 for helium.

**Discussion** We are assuming, of course, that these gases behave as ideal gases – a good approximation at room temperature.

---

## 2-55C

**Solution** We are to compare the speed of sound in air at two different pressures, but the same temperature.

**Analysis** Air at specified conditions will behave like an ideal gas, and *the speed of sound in an ideal gas depends on temperature only*. Therefore, **the speed of sound is the same in both mediums**.

**Discussion** If the temperature were different, however, the speed of sound would be different.

---

## 2-56C

**Solution** We are to examine whether the Mach number remains constant in constant-velocity flow.

**Analysis** In general, **no**, because the Mach number also depends on the speed of sound in gas, which depends on the temperature of the gas. **The Mach number remains constant only if the temperature and the velocity are constant**.

**Discussion** It turns out that the speed of sound is not a strong function of pressure. In fact, it is not a function of pressure at all for an ideal gas.

---

## 2-57C

**Solution** We are to state whether the propagation of sound waves is an isentropic process.

**Analysis** **Yes, the propagation of sound waves is nearly isentropic**. Because the amplitude of an ordinary sound wave is very small, and it does not cause any significant change in temperature and pressure.

**Discussion** No process is truly isentropic, but the increase of entropy due to sound propagation is negligibly small.

---

## 2-58C

**Solution** We are to discuss sonic velocity – specifically, whether it is constant or it changes.

**Analysis** The *sonic speed* in a medium **depends on the properties of the medium, and it changes as the properties of the medium change**.

**Discussion** The most common example is the change in speed of sound due to temperature change.

---

## 2-59

**Solution** The expression for the speed of sound for an ideal gas is to be obtained using the isentropic process equation and the definition of the speed of sound.

**Analysis** The isentropic relation  $Pv^k = A$  where  $A$  is a constant can also be expressed as

$$P = A \left( \frac{1}{v} \right)^k = A \rho^k$$

Substituting it into the relation for the speed of sound,

$$c^2 = \left( \frac{\partial P}{\partial \rho} \right)_s = \left( \frac{\partial (A \rho^k)}{\partial \rho} \right)_s = k A \rho^{k-1} = k (A \rho^k) / \rho = k (P / \rho) = k R T$$

since for an ideal gas  $P = \rho R T$  or  $R T = P / \rho$ . Therefore,  $c = \sqrt{k R T}$ , which is the desired relation.

**Discussion** Notice that pressure has dropped out; the speed of sound in an ideal gas is *not* a function of pressure.

---

## 2-60

**Solution** Carbon dioxide flows through a nozzle. The inlet temperature and velocity and the exit temperature of  $\text{CO}_2$  are specified. The Mach number is to be determined at the inlet and exit of the nozzle.

**Assumptions** 1  $\text{CO}_2$  is an ideal gas with constant specific heats at room temperature. 2 This is a steady-flow process.

**Properties** The gas constant of carbon dioxide is  $R = 0.1889 \text{ kJ/kg}\cdot\text{K}$ . Its constant pressure specific heat and specific heat ratio at room temperature are  $c_p = 0.8439 \text{ kJ/kg}\cdot\text{K}$  and  $k = 1.288$ .

**Analysis** (a) At the inlet

$$c_1 = \sqrt{k_1 R T_1} = \sqrt{(1.288)(0.1889 \text{ kJ/kg}\cdot\text{K})(1200 \text{ K}) \left( \frac{1000 \text{ m}^2/\text{s}^2}{1 \text{ kJ/kg}} \right)} = 540.3 \text{ m/s}$$

Thus,

$$\text{Ma}_1 = \frac{V_1}{c_1} = \frac{50 \text{ m/s}}{540.3 \text{ m/s}} = \mathbf{0.0925}$$

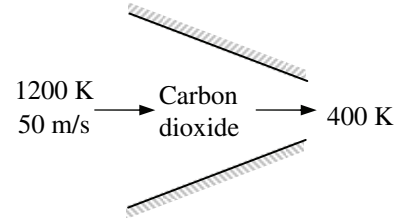

(b) At the exit,

$$c_2 = \sqrt{k_2 R T_2} = \sqrt{(1.288)(0.1889 \text{ kJ/kg}\cdot\text{K})(400 \text{ K}) \left( \frac{1000 \text{ m}^2/\text{s}^2}{1 \text{ kJ/kg}} \right)} = 312.0 \text{ m/s}$$

The nozzle exit velocity is determined from the steady-flow energy balance relation,

$$0 = h_2 - h_1 + \frac{V_2^2 - V_1^2}{2} \rightarrow 0 = c_p(T_2 - T_1) + \frac{V_2^2 - V_1^2}{2}$$

$$0 = (0.8439 \text{ kJ/kg}\cdot\text{K})(400 - 1200 \text{ K}) + \frac{V_2^2 - (50 \text{ m/s})^2}{2} \left( \frac{1 \text{ kJ/kg}}{1000 \text{ m}^2/\text{s}^2} \right) \longrightarrow V_2 = 1163 \text{ m/s}$$

Thus,

$$\text{Ma}_2 = \frac{V_2}{c_2} = \frac{1163 \text{ m/s}}{312 \text{ m/s}} = \mathbf{3.73}$$

**Discussion** The specific heats and their ratio  $k$  change with temperature, and the accuracy of the results can be improved by accounting for this variation. Using EES (or another property database):

$$\text{At } 1200 \text{ K: } c_p = 1.278 \text{ kJ/kg}\cdot\text{K}, k = 1.173 \rightarrow c_1 = 516 \text{ m/s}, V_1 = 50 \text{ m/s}, \text{Ma}_1 = 0.0969$$

$$\text{At } 400 \text{ K: } c_p = 0.9383 \text{ kJ/kg}\cdot\text{K}, k = 1.252 \rightarrow c_2 = 308 \text{ m/s}, V_2 = 1356 \text{ m/s}, \text{Ma}_2 = 4.41$$

Therefore, the constant specific heat assumption results in an error of **4.5%** at the inlet and **15.5%** at the exit in the Mach number, which are significant.

## 2-61

**Solution** Nitrogen flows through a heat exchanger. The inlet temperature, pressure, and velocity and the exit pressure and velocity are specified. The Mach number is to be determined at the inlet and exit of the heat exchanger.

**Assumptions** 1  $N_2$  is an ideal gas. 2 This is a steady-flow process. 3 The potential energy change is negligible.

**Properties** The gas constant of  $N_2$  is  $R = 0.2968 \text{ kJ/kg}\cdot\text{K}$ . Its constant pressure specific heat and specific heat ratio at room temperature are  $c_p = 1.040 \text{ kJ/kg}\cdot\text{K}$  and  $k = 1.4$ .

**Analysis** The speed of sound at the inlet is

$$\begin{aligned} c_1 &= \sqrt{k_1 R T_1} \\ &= \sqrt{(1.400)(0.2968 \text{ kJ/kg}\cdot\text{K})(283 \text{ K}) \left( \frac{1000 \text{ m}^2/\text{s}^2}{1 \text{ kJ/kg}} \right)} \\ &= 342.9 \text{ m/s} \end{aligned}$$

Thus,

$$\text{Ma}_1 = \frac{V_1}{c_1} = \frac{100 \text{ m/s}}{342.9 \text{ m/s}} = \mathbf{0.292}$$

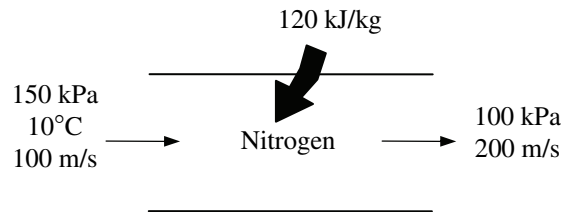

From the energy balance on the heat exchanger,

$$\begin{aligned} q_{\text{in}} &= c_p(T_2 - T_1) + \frac{V_2^2 - V_1^2}{2} \\ 120 \text{ kJ/kg} &= (1.040 \text{ kJ/kg}\cdot^\circ\text{C})(T_2 - 10^\circ\text{C}) + \frac{(200 \text{ m/s})^2 - (100 \text{ m/s})^2}{2} \left( \frac{1 \text{ kJ/kg}}{1000 \text{ m}^2/\text{s}^2} \right) \end{aligned}$$

It yields

$$T_2 = 111^\circ\text{C} = 384 \text{ K}$$

$$c_2 = \sqrt{k_2 R T_2} = \sqrt{(1.4)(0.2968 \text{ kJ/kg}\cdot\text{K})(384 \text{ K}) \left( \frac{1000 \text{ m}^2/\text{s}^2}{1 \text{ kJ/kg}} \right)} = 399 \text{ m/s}$$

Thus,

$$\text{Ma}_2 = \frac{V_2}{c_2} = \frac{200 \text{ m/s}}{399 \text{ m/s}} = \mathbf{0.501}$$

**Discussion** The specific heats and their ratio  $k$  change with temperature, and the accuracy of the results can be improved by accounting for this variation. Using EES (or another property database):

$$\text{At } 10^\circ\text{C} : c_p = 1.038 \text{ kJ/kg}\cdot\text{K}, k = 1.400 \rightarrow c_1 = 343 \text{ m/s}, V_1 = 100 \text{ m/s}, \text{Ma}_1 = 0.292$$

$$\text{At } 111^\circ\text{C} : c_p = 1.041 \text{ kJ/kg}\cdot\text{K}, k = 1.399 \rightarrow c_2 = 399 \text{ m/s}, V_2 = 200 \text{ m/s}, \text{Ma}_2 = 0.501$$

Therefore, the constant specific heat assumption results in an error of **4.5%** at the inlet and **15.5%** at the exit in the Mach number, which are almost identical to the values obtained assuming constant specific heats.

## 2-62

**Solution** The speed of sound in refrigerant-134a at a specified state is to be determined.

**Assumptions** R-134a is an ideal gas with constant specific heats at room temperature.

**Properties** The gas constant of R-134a is  $R = 0.08149 \text{ kJ/kg}\cdot\text{K}$ . Its specific heat ratio at room temperature is  $k = 1.108$ .

**Analysis** From the ideal-gas speed of sound relation,

$$c = \sqrt{kRT} = \sqrt{(1.108)(0.08149 \text{ kJ/kg}\cdot\text{K})(70 + 273 \text{ K}) \left( \frac{1000 \text{ m}^2/\text{s}^2}{1 \text{ kJ/kg}} \right)} = \mathbf{176 \text{ m/s}}$$

**Discussion** Note that the speed of sound is independent of pressure for ideal gases.

---

## 2-63

**Solution** The Mach number of an aircraft and the speed of sound in air are to be determined at two specified temperatures.

**Assumptions** Air is an ideal gas with constant specific heats at room temperature.

**Properties** The gas constant of air is  $R = 0.287 \text{ kJ/kg}\cdot\text{K}$ . Its specific heat ratio at room temperature is  $k = 1.4$ .

**Analysis** From the definitions of the speed of sound and the Mach number,

(a) At 300 K,

$$c = \sqrt{kRT} = \sqrt{(1.4)(0.287 \text{ kJ/kg}\cdot\text{K})(300 \text{ K}) \left( \frac{1000 \text{ m}^2/\text{s}^2}{1 \text{ kJ/kg}} \right)} = \mathbf{347 \text{ m/s}}$$

and

$$\text{Ma} = \frac{V}{c} = \frac{330 \text{ m/s}}{347 \text{ m/s}} = \mathbf{0.951}$$

(b) At 800 K,

$$c = \sqrt{kRT} = \sqrt{(1.4)(0.287 \text{ kJ/kg}\cdot\text{K})(800 \text{ K}) \left( \frac{1000 \text{ m}^2/\text{s}^2}{1 \text{ kJ/kg}} \right)} = \mathbf{567 \text{ m/s}}$$

and

$$\text{Ma} = \frac{V}{c} = \frac{330 \text{ m/s}}{567 \text{ m/s}} = \mathbf{0.582}$$

**Discussion** Note that a constant Mach number does not necessarily indicate constant speed. The Mach number of a rocket, for example, will be increasing even when it ascends at constant speed. Also, the specific heat ratio  $k$  changes with temperature.

---

## 2-64E

**Solution** Steam flows through a device at a specified state and velocity. The Mach number of steam is to be determined assuming ideal gas behavior.

**Assumptions** Steam is an ideal gas with constant specific heats.

**Properties** The gas constant of steam is  $R = 0.1102 \text{ Btu/lbm}\cdot\text{R}$ . Its specific heat ratio is given to be  $k = 1.3$ .

**Analysis** From the ideal-gas speed of sound relation,

$$c = \sqrt{kRT} = \sqrt{(1.3)(0.1102 \text{ Btu/lbm}\cdot\text{R})(1160 \text{ R}) \left( \frac{25,037 \text{ ft}^2/\text{s}^2}{1 \text{ Btu/lbm}} \right)} = 2040 \text{ ft/s}$$

Thus,

$$\text{Ma} = \frac{V}{c} = \frac{900 \text{ ft/s}}{2040 \text{ ft/s}} = \mathbf{0.441}$$

**Discussion** Using property data from steam tables and not assuming ideal gas behavior, it can be shown that the Mach number in steam at the specified state is 0.446, which is sufficiently close to the ideal-gas value of 0.441. Therefore, the ideal gas approximation is a reasonable one in this case.

---

2-65E 

**Solution** Problem 2-64E is reconsidered. The variation of Mach number with temperature as the temperature changes between 350° and 700°F is to be investigated, and the results are to be plotted.

**Analysis** The EES *Equations* window is printed below, along with the tabulated and plotted results.

```
T=Temperature+460
R=0.1102
V=900
k=1.3
c=SQRT(k*R*T*25037)
Ma=V/c
```

Temperature, $T, ^\circ\text{F}$	Mach number Ma
350	0.528
375	0.520
400	0.512
425	0.505
450	0.498
475	0.491
500	0.485
525	0.479
550	0.473
575	0.467
600	0.462
625	0.456
650	0.451
675	0.446
700	0.441

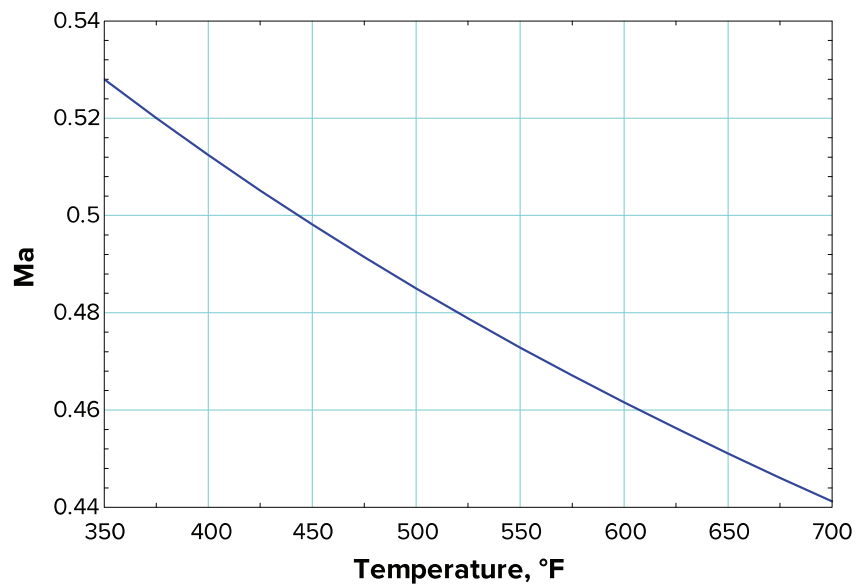

**Discussion** Note that for a specified flow speed, the Mach number decreases with increasing temperature, as expected.



## 2-66

**Solution** The inlet state and the exit pressure of air are given for an isentropic expansion process. The ratio of the initial to the final speed of sound is to be determined.

**Assumptions** Air is an ideal gas with constant specific heats at room temperature.

**Properties** The properties of air are  $R = 0.287$  kJ/kg·K and  $k = 1.4$ . The specific heat ratio  $k$  varies with temperature, but in our case this change is very small and can be disregarded.

**Analysis** The final temperature of air is determined from the isentropic relation of ideal gases,

$$T_2 = T_1 \left( \frac{P_2}{P_1} \right)^{(k-1)/k} = (350.2 \text{ K}) \left( \frac{0.4 \text{ MPa}}{2.2 \text{ MPa}} \right)^{(1.4-1)/1.4} = 215.2 \text{ K}$$

Treating  $k$  as a constant, the ratio of the initial to the final speed of sound can be expressed as

$$\text{Ratio} = \frac{c_2}{c_1} = \frac{\sqrt{k_1 RT_1}}{\sqrt{k_2 RT_2}} = \frac{\sqrt{T_1}}{\sqrt{T_2}} = \frac{\sqrt{350.2}}{\sqrt{215.2}} = \mathbf{1.28}$$

**Discussion** Note that the speed of sound is proportional to the square root of thermodynamic temperature.

---

## 2-67

**Solution** The inlet state and the exit pressure of helium are given for an isentropic expansion process. The ratio of the initial to the final speed of sound is to be determined.

**Assumptions** Helium is an ideal gas with constant specific heats at room temperature.

**Properties** The properties of helium are  $R = 2.0769$  kJ/kg·K and  $k = 1.667$ .

**Analysis** The final temperature of helium is determined from the isentropic relation of ideal gases,

$$T_2 = T_1 \left( \frac{P_2}{P_1} \right)^{(k-1)/k} = (350.2 \text{ K}) \left( \frac{0.4}{2.2} \right)^{(1.667-1)/1.667} = 177.0 \text{ K}$$

The ratio of the initial to the final speed of sound can be expressed as

$$\text{Ratio} = \frac{c_2}{c_1} = \frac{\sqrt{k_1 RT_1}}{\sqrt{k_2 RT_2}} = \frac{\sqrt{T_1}}{\sqrt{T_2}} = \frac{\sqrt{350.2}}{\sqrt{177.0}} = \mathbf{1.41}$$

**Discussion** Note that the speed of sound is proportional to the square root of thermodynamic temperature.

---

2-68

**Solution** The Mach number of a passenger plane for specified limiting operating conditions is to be determined.

**Assumptions** Air is an ideal gas with constant specific heats at room temperature.

**Properties** The gas constant of air is  $R = 0.287 \text{ kJ/kg}\cdot\text{K}$ . Its specific heat ratio at room temperature is  $k = 1.4$ .

**Analysis** From the speed of sound relation

$$c = \sqrt{kRT} = \sqrt{(1.4)(0.287 \text{ kJ/kg}\cdot\text{K})(-60 + 273 \text{ K}) \left( \frac{1000 \text{ m}^2/\text{s}^2}{1 \text{ kJ/kg}} \right)} = 293 \text{ m/s}$$

Thus, the Mach number corresponding to the maximum cruising speed of the plane is

$$\text{Ma} = \frac{V_{\max}}{c} = \frac{(945/3.6) \text{ m/s}}{293 \text{ m/s}} = \mathbf{0.897}$$

**Discussion** Note that this is a subsonic flight since  $\text{Ma} < 1$ . Also, using a  $k$  value at  $-60^\circ\text{C}$  would give practically the same result.

---

---

**Viscosity**

---

**2-69C**

**Solution** We are to discuss Newtonian fluids.

**Analysis** **Fluids whose shear stress is linearly proportional to the velocity gradient** (shear strain) are called *Newtonian fluids*. Most common fluids such as water, air, gasoline, and oils are Newtonian fluids.

**Discussion** In the differential analysis of fluid flow, only Newtonian fluids are considered in this textbook.

---

**2-70C**

**Solution** We are to define and discuss viscosity.

**Analysis** *Viscosity is a measure of the “stickiness” or “resistance to deformation” of a fluid.* It is due to the internal frictional force that develops between different layers of fluids as they are forced to move relative to each other. Viscosity is caused by the cohesive forces between the molecules in liquids, and by the molecular collisions in gases. In general, **liquids have higher dynamic viscosities than gases.**

**Discussion** The ratio of viscosity  $\mu$  to density  $\rho$  often appears in the equations of fluid mechanics, and is defined as the *kinematic viscosity*,  $\nu = \mu / \rho$ .

---

**2-71C**

**Solution** We are to discuss how kinematic viscosity varies with temperature in liquids and gases.

**Analysis** (a) **For liquids, the kinematic viscosity decreases with temperature.** (b) **For gases, the kinematic viscosity increases with temperature.**

**Discussion** You can easily verify this by looking at the appendices.

---

## 2-72C

**Solution** We are to compare the settling speed of balls dropped in water and oil; namely, we are to determine which will reach the bottom of the container first.

**Analysis** When two identical small glass balls are dropped into two identical containers, one filled with water and the other with oil, **the ball dropped in water will reach the bottom of the container first** because of the much lower viscosity of water relative to oil.

**Discussion** Oil is very viscous, with typical values of viscosity approximately 800 times greater than that of water at room temperature.

---

## 2-73E

**Solution** The torque and the rpm of a double cylinder viscometer are given. The viscosity of the fluid is to be determined.

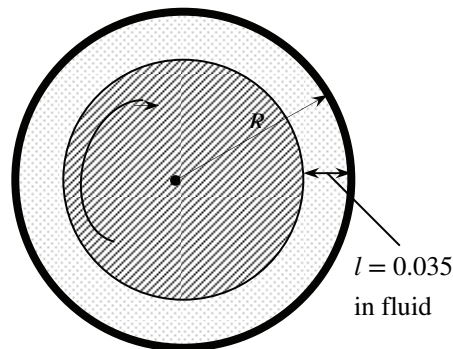

**Assumptions** 1 The inner cylinder is completely submerged in the fluid. 2 The viscous effects on the two ends of the inner cylinder are negligible. 3 The fluid is Newtonian.

**Analysis** Substituting the given values, the viscosity of the fluid is determined to be

$$\mu = \frac{\mathbf{T}l}{4\pi^2 R^3 \dot{n}L} = \frac{(1.2 \text{ lbf} \cdot \text{ft})(0.035/12 \text{ ft})}{4\pi^2 (3/12 \text{ ft})^3 (250/60 \text{ s}^{-1})(5 \text{ ft})} = 2.72 \times 10^{-4} \text{ lbf} \cdot \text{s/ft}^2$$

**Discussion** This is the viscosity value at temperature that existed during the experiment. Viscosity is a strong function of temperature, and the values can be significantly different at different temperatures.

---

## 2-74

**Solution** The viscosities of carbon dioxide at two temperatures are given. The constants of Sutherland correlation for carbon dioxide are to be determined and the viscosity of carbon dioxide at a specified temperature is to be predicted and compared to the value in table A-10.

**Analysis** Sutherland correlation is given by Eq. 2–32 as

$$\mu = \frac{a\sqrt{T}}{1+b/T}$$

where  $T$  is the absolute temperature. Substituting the given values we have

$$\mu_1 = \frac{a\sqrt{T_1}}{1+b/T_1} = \frac{a\sqrt{50+273.15}}{1+\frac{b}{50+273.15}} \rightarrow 1.612 \times 10^{-5} = \frac{a\sqrt{323.15}}{1+\frac{b}{323.15}}$$

$$\mu_2 = \frac{a\sqrt{T_2}}{1+b/T_2} = \frac{a\sqrt{200+273.15}}{1+\frac{b}{200+273.15}} \rightarrow 2.276 \times 10^{-5} = \frac{a\sqrt{473.15}}{1+\frac{b}{473.15}}$$

which is a nonlinear system of two algebraic equations. Using EES or any other computer code, one finds the following result:

$$a = 1.633 \times 10^{-6} \text{ kg}/(\text{m} \cdot \text{s} \cdot \text{K}^{1/2}) \quad b = 265.5 \text{ K}$$

Using these values the Sutherland correlation becomes

$$\mu = \frac{1.633 \times 10^{-6} \sqrt{T}}{1+265.5/T}$$

Therefore the viscosity at 100°C is found to be

$$\mu = \frac{1.633 \times 10^{-6} \sqrt{373.15}}{1+265.5/373.15} = 1.843 \times 10^{-5} \text{ Pa} \cdot \text{s}$$

The agreement is perfect and within approximately 0.1%.

2-75

**Solution** The velocity profile of a fluid flowing through a circular pipe is given. The friction drag force exerted on the pipe by the fluid in the flow direction per unit length of the pipe is to be determined.

**Assumptions** The viscosity of the fluid is constant.

**Analysis** The wall shear stress is determined from its definition to be

$$\tau_w = -\mu \left. \frac{du}{dr} \right|_{r=R} = -\mu u_{\max} \left. \frac{d}{dr} \left( 1 - \frac{r^n}{R^n} \right) \right|_{r=R} = -\mu u_{\max} \left. \frac{-nr^{n-1}}{R^n} \right|_{r=R} = \frac{n\mu u_{\max}}{R}$$

Note that the quantity  $du/dr$  is negative in pipe flow, and the negative sign is added to the  $\tau_w$  relation for pipes to make shear stress in the positive (flow) direction a positive quantity. (Or,  $du/dr = -du/dy$  since  $y = R - r$ ). Then the friction drag force exerted by the fluid on the inner surface of the pipe becomes

$$F = \tau_w A_w = \frac{n\mu u_{\max}}{R} (2\pi R)L = 2n\pi\mu u_{\max} L$$

Therefore, the drag force per unit length of the pipe is

$$\boxed{F/L = 2n\pi\mu u_{\max}}$$

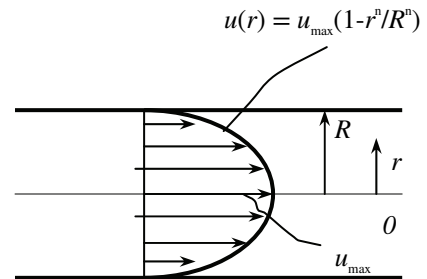

**Discussion** Note that the drag force acting on the pipe in this case is independent of the pipe diameter.

2-76

**Solution** The torque and the rpm of a double cylinder viscometer are given. The viscosity of the fluid is to be determined.

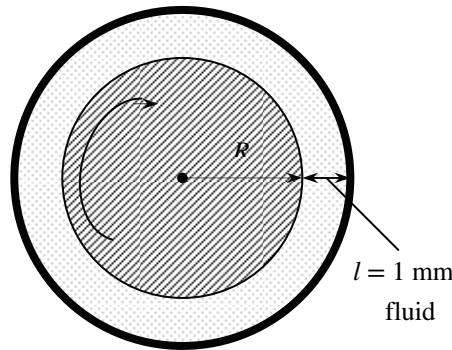

**Assumptions** 1 The inner cylinder is completely submerged in oil. 2 The viscous effects on the two ends of the inner cylinder are negligible. 3 The fluid is Newtonian.

**Analysis** Substituting the given values, the viscosity of the fluid is determined to be

$$\mu = \frac{Tl}{4\pi^2 R^3 nL} = \frac{(0.8 \text{ N}\cdot\text{m})(0.001 \text{ m})}{4\pi^2 (0.075 \text{ m})^3 (300/60 \text{ s}^{-1})(0.75 \text{ m})} = \mathbf{0.0128 \text{ N}\cdot\text{s/m}^2}$$

**Discussion** This is the viscosity value at the temperature that existed during the experiment. Viscosity is a strong function of temperature, and the values can be significantly different at different temperatures.

## 2-77

**Solution** A thin flat plate is pulled horizontally through an oil layer sandwiched between two plates, one stationary and the other moving at a constant velocity. The location in oil where the velocity is zero and the force that needs to be applied on the plate are to be determined.

**Assumptions** 1 The thickness of the plate is negligible. 2 The velocity profile in each oil layer is linear.

**Properties** The absolute viscosity of oil is given to be  $\mu = 0.027 \text{ Pa}\cdot\text{s} = 0.027 \text{ N}\cdot\text{s}/\text{m}^2$ .

**Analysis** (a) The velocity profile in each oil layer relative to the fixed wall is as shown in the figure below. The point of zero velocity is indicated by point A, and its distance from the lower plate is determined from geometric considerations (the similarity of the two triangles in the lower oil layer) to be

$$\frac{2.6 - y_A}{y_A} = \frac{3}{0.3} \rightarrow y_A = \mathbf{0.23636 \text{ mm}}$$

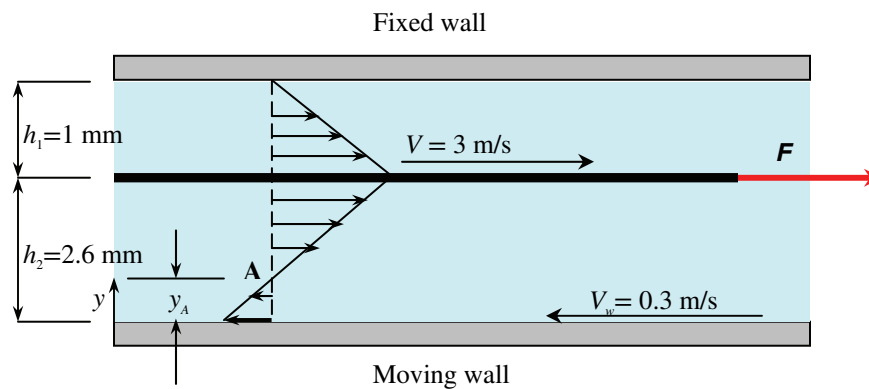

(b) The magnitudes of shear forces acting on the upper and lower surfaces of the plate are

$$F_{\text{shear, upper}} = \tau_{w, \text{upper}} A_s = \mu A_s \left. \frac{du}{dy} \right|_{\text{upper}} = \mu A_s \frac{V - 0}{h_1} = (0.027 \text{ N}\cdot\text{s}/\text{m}^2)(0.3 \times 0.3 \text{ m}^2) \frac{3 \text{ m/s}}{1.0 \times 10^{-3} \text{ m}} = 7.29 \text{ N}$$

$$F_{\text{shear, lower}} = \tau_{w, \text{lower}} A_s = \mu A_s \left. \frac{du}{dy} \right|_{\text{lower}} = \mu A_s \frac{V - V_w}{h_2} = (0.027 \text{ N}\cdot\text{s}/\text{m}^2)(0.3 \times 0.3 \text{ m}^2) \frac{[3 - (-0.3)] \text{ m/s}}{2.6 \times 10^{-3} \text{ m}} = 3.08 \text{ N}$$

Noting that both shear forces are in the opposite direction of motion of the plate, the force  $F$  is determined from a force balance on the plate to be

$$F = F_{\text{shear, upper}} + F_{\text{shear, lower}} = 7.29 + 3.08 = \mathbf{10.4 \text{ N}}$$

**Discussion** Note that wall shear is a friction force between a solid and a liquid, and it acts in the opposite direction of motion.

## 2-78

**Solution** We are to determine the torque required to rotate the inner cylinder of two concentric cylinders, with the inner cylinder rotating and the outer cylinder stationary. We are also to explain what happens when the gap gets bigger.

**Assumptions** 1 The fluid is incompressible and Newtonian. 2 End effects (top and bottom) are negligible. 3 The gap is very small so that wall curvature effects are negligible. 4 The gap is so small that the velocity profile in the gap is linear.

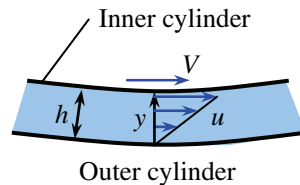

**Analysis** (a) We assume a linear velocity profile between the two walls as sketched – the inner wall is moving at speed  $V = \omega_i R_i$  and the outer wall is stationary. The thickness of the gap is  $h$ , and we let  $y$  be the distance from the outer wall into the fluid (towards the inner wall). Thus,

$$u = V \frac{y}{h} \quad \text{and} \quad \tau = \mu \frac{du}{dy} = \mu \frac{V}{h}$$

where

$$h = R_o - R_i \quad \text{and} \quad V = \omega_i R_i$$

Since shear stress  $\tau$  has dimensions of force/area, the clockwise (mathematically negative) tangential force acting along the surface of the inner cylinder by the fluid is

$$F = -\tau A = -\mu \frac{V}{h} 2\pi R_i L = -\frac{\mu \omega_i R_i}{R_o - R_i} 2\pi R_i L$$

But the torque is the tangential force times the moment arm  $R_i$ . Also, we are asked for the torque required to turn the inner cylinder. This applied torque is counterclockwise (mathematically positive). Thus,

$$\boxed{T = -FR_i = \frac{2\pi L \mu \omega_i R_i^3}{R_o - R_i} = \frac{2\pi L \mu \omega_i R_i^3}{h}}$$

(b) The above is only an **approximation because we assumed a linear velocity profile**. As long as the gap is very small, and therefore the wall curvature effects are negligible, this approximation should be very good. Another way to think about this is that when the gap is very small compared to the cylinder radii, a magnified view of the flow in the gap appears similar to flow between two infinite walls (Couette flow). However, as the gap increases, the curvature effects are no longer negligible, and the linear velocity profile is not expected to be a valid approximation. **We do not expect the velocity to remain linear as the gap increases.**

**Discussion** It is possible to solve for the exact velocity profile for this problem, and therefore the torque can be found analytically, but this has to wait until the differential analysis chapter.



## 2-79

**Solution** A clutch system is used to transmit torque through an oil film between two identical disks. For specified rotational speeds, the transmitted torque is to be determined.

**Assumptions** 1 The thickness of the oil film is uniform. 2 The rotational speeds of the disks remain constant.

**Properties** The absolute viscosity of oil is given to be  $\mu = 0.38 \text{ N}\cdot\text{s}/\text{m}^2$ .

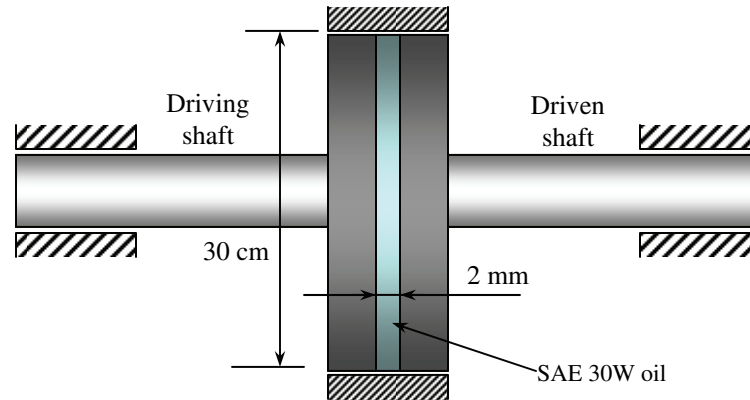

**Analysis** The disks are rotating in the same direction at different angular speeds of  $\omega_1$  and of  $\omega_2$ . Therefore, we can assume one of the disks to be stationary and the other to be rotating at an angular speed of  $\omega_1 - \omega_2$ . The velocity gradient anywhere in the oil of film thickness  $h$  is  $V/h$  where  $V = (\omega_1 - \omega_2)r$  is the tangential velocity. Then the wall shear stress anywhere on the surface of the faster disk at a distance  $r$  from the axis of rotation can be expressed as

$$\tau_w = \mu \frac{du}{dr} = \mu \frac{V}{h} = \mu \frac{(\omega_1 - \omega_2)r}{h}$$

Then the shear force acting on a differential area  $dA$  on the surface and the torque generation associated with it can be expressed as

$$dF = \tau_w dA = \mu \frac{(\omega_1 - \omega_2)r}{h} (2\pi r) dr$$

$$d\Gamma = r dF = \mu \frac{(\omega_1 - \omega_2)r^2}{h} (2\pi r) dr = \frac{2\pi\mu(\omega_1 - \omega_2)}{h} r^3 dr$$

Integrating,

$$\Gamma = \frac{2\pi\mu(\omega_1 - \omega_2)}{h} \int_{r=0}^{D/2} r^3 dr = \frac{2\pi\mu(\omega_1 - \omega_2)}{h} \frac{r^4}{4} \Big|_{r=0}^{D/2} = \frac{\pi\mu(\omega_1 - \omega_2)D^4}{32h}$$

Noting that  $\omega = 2\pi \dot{n}$ , the relative angular speed is

$$\omega_1 - \omega_2 = 2\pi(\dot{n}_1 - \dot{n}_2) = (2\pi \text{ rad/s})[(1200 - 1125) \text{ rev/min}] \left( \frac{1 \text{ min}}{60 \text{ s}} \right) = 7.854 \text{ rad/s}$$

Substituting, the torque transmitted is determined to be

$$\Gamma = \frac{\pi(0.38 \text{ N}\cdot\text{s}/\text{m}^2)(7.854 \text{ /s})(0.30 \text{ m})^4}{32(0.002 \text{ m})} = \mathbf{1.19 \text{ N}\cdot\text{m}}$$

**Discussion** Note that the torque transmitted is proportional to the fourth power of disk diameter, and is inversely proportional to the thickness of the oil film.

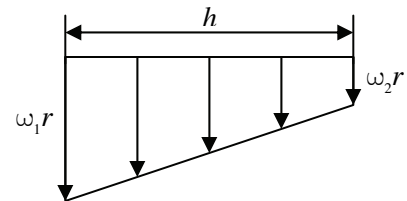

2-80



**Solution** We are to investigate the effect of oil film thickness on the transmitted torque.

**Analysis** The previous problem is reconsidered. Using EES software, the effect of oil film thickness on the torque transmitted is investigated. Film thickness varied from 0.1 mm to 10 mm, and the results are tabulated and plotted. The relation used is  $T = \frac{\pi\mu(\omega_1 - \omega_2)D^4}{32h}$ . The EES *Equations* window is printed below, followed by the tabulated and plotted results.

```
mu=0.38 [N-s/m^2]
n1=1200 [rpm]
n2=1125 [rpm]
D=0.3 [m]
h=0.002 [m]
w1=2*pi*n1/60
w2=2*pi*n2/60
Tq=pi*mu*(w1-w2)*(D^4)/(32*h)
```

Film thickness $h$ , mm	Torque transmitted $T$ , N·m
0.1	23.73
0.2	11.87
0.4	5.933
0.6	3.956
0.8	2.967
1	2.373
2	1.187
4	0.5933
6	0.3956
8	0.2967
10	0.2373

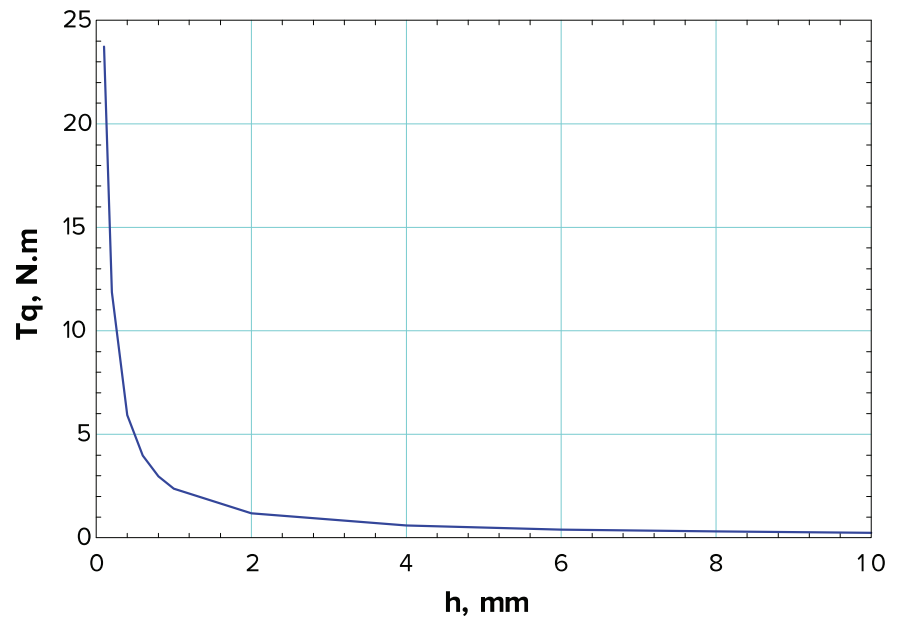

**Conclusion** Torque transmitted is inversely proportional to oil film thickness, and the film thickness should be as small as possible to maximize the transmitted torque.

**Discussion** To obtain the solution in EES, we set up a parametric table, specify  $h$ , and let EES calculate  $T$  for each value of  $h$ .

## 2-81

**Solution** A block is moved at constant velocity on an inclined surface. The force that needs to be applied in the horizontal direction when the block is dry, and the percent reduction in the required force when an oil film is applied on the surface are to be determined.

**Assumptions** 1 The inclined surface is plane (perfectly flat, although tilted). 2 The friction coefficient and the oil film thickness are uniform. 3 The weight of the oil layer is negligible.

**Properties** The absolute viscosity of oil is given to be  $\mu = 0.012 \text{ Pa}\cdot\text{s} = 0.012 \text{ N}\cdot\text{s}/\text{m}^2$ .

**Analysis** (a) The velocity of the block is constant, and thus its acceleration and the net force acting on it are zero. A free body diagram of the block is given. Then the force balance gives

$$\sum F_x = 0: F_1 - F_f \cos 20^\circ - F_{N1} \sin 20^\circ = 0 \quad (1)$$

$$\sum F_y = 0: F_{N1} \cos 20^\circ - F_f \sin 20^\circ - W = 0 \quad (2)$$

$$\text{Friction force: } F_f = fF_{N1} \quad (3)$$

Substituting Eq. (3) into Eq. (2) and solving for  $F_{N1}$  gives

$$F_{N1} = \frac{W}{\cos 20^\circ - f \sin 20^\circ} = \frac{150 \text{ N}}{\cos 20^\circ - 0.27 \sin 20^\circ} = 177.0 \text{ N}$$

Then from Eq. (1):

$$F_1 = F_f \cos 20^\circ + F_{N1} \sin 20^\circ = (0.27 \times 177 \text{ N}) \cos 20^\circ + (177 \text{ N}) \sin 20^\circ = \mathbf{105.5 \text{ N}}$$

(b) In this case, the friction force is replaced by the shear force applied on the bottom surface of the block due to the oil. Because of the no-slip condition, the oil film sticks to the inclined surface at the bottom and the lower surface of the block at the top. Then the shear force is expressed as

$$\begin{aligned} F_{shear} &= \tau_w A_s = \mu A_s \frac{V}{h} \\ &= (0.012 \text{ N}\cdot\text{s}/\text{m}^2)(0.5 \times 0.2 \text{ m}^2) \frac{1.10 \text{ m/s}}{4 \times 10^{-4} \text{ m}} \\ &= 3.3 \text{ N} \end{aligned}$$

Replacing the friction force by the shear force in part (a),

$$\sum F_x = 0: F_2 - F_{shear} \cos 20^\circ - F_{N2} \sin 20^\circ = 0 \quad (4)$$

$$\sum F_y = 0: F_{N2} \cos 20^\circ - F_{shear} \sin 20^\circ - W = 0 \quad (5)$$

Eq. (5) gives

$$F_{N2} = (F_{shear} \sin 20^\circ + W) / \cos 20^\circ = [(3.3 \text{ N}) \sin 20^\circ + (150 \text{ N})] / \cos 20^\circ = 159.7 \text{ N}$$

Substituting into Eq. (4), the required horizontal force is determined to be

$$F_2 = F_{shear} \cos 20^\circ + F_{N2} \sin 20^\circ = (3.3 \text{ N}) \cos 20^\circ + (159.7 \text{ N}) \sin 20^\circ = 57.7 \text{ N}$$

Then, our final result is expressed as

$$\text{Percentage reduced in required force} = \frac{F_1 - F_2}{F_2} \times 100\% = \frac{105.5 - 57.7}{57.7} \times 100\% = \mathbf{45.3\%}$$

**Discussion** Note that the force required to push the block on the inclined surface reduces significantly by oiling the surface.

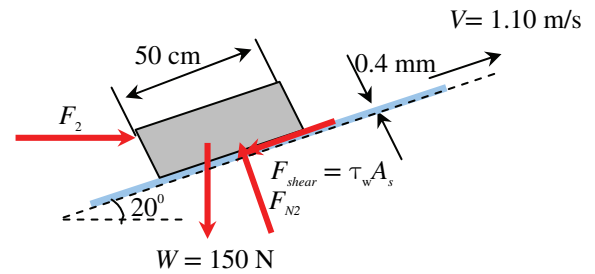
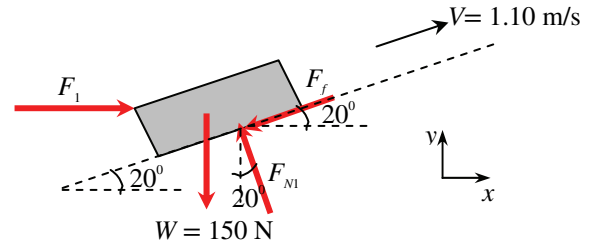

## 2-82

**Solution** For flow over a plate, the variation of velocity with distance is given. A relation for the wall shear stress is to be obtained.

**Assumptions** The fluid is Newtonian.

**Analysis** Noting that  $u(y) = ay - by^2$ , wall shear stress is determined from its definition to be

$$\tau_w = \mu \left. \frac{du}{dy} \right|_{y=0} = \mu \left. \frac{d(ay - by^2)}{dy} \right|_{y=0} = \mu(a - 2by)|_{y=0} = a\mu$$

**Discussion** Note that shear stress varies with vertical distance in this case.

## 2-83

**Solution** The velocity profile for laminar one-dimensional flow through a circular pipe is given. A relation for friction drag force exerted on the pipe and its numerical value for water are to be determined.

**Assumptions** 1 The flow through the circular pipe is one-dimensional. 2 The fluid is Newtonian.

**Properties** The viscosity of water at 20°C is given to be 0.0010 kg/m·s.

**Analysis** (a) The velocity profile is given by  $u(r) = u_{\max} \left( 1 - \frac{r^2}{R^2} \right)$

where  $R$  is the radius of the pipe,  $r$  is the radial distance from the center of the pipe, and  $u_{\max}$  is the maximum flow velocity, which occurs at the center,  $r = 0$ . The shear stress at the pipe surface is expressed as

$$\tau_w = -\mu \left. \frac{du}{dr} \right|_{r=R} = -\mu u_{\max} \left. \frac{d}{dr} \left( 1 - \frac{r^2}{R^2} \right) \right|_{r=R} = -\mu u_{\max} \left. \frac{-2r}{R^2} \right|_{r=R} = \frac{2\mu u_{\max}}{R}$$

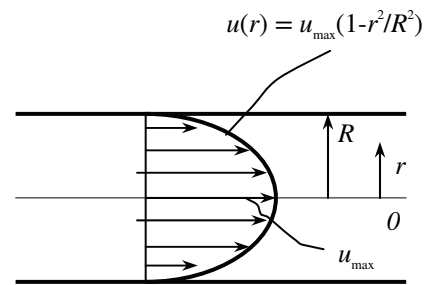

Note that the quantity  $du/dr$  is negative in pipe flow, and the negative sign is added to the  $\tau_w$  relation for pipes to make shear stress in the positive (flow) direction a positive quantity. (Or,  $du/dr = -du/dy$  since  $y = R - r$ ). Then the friction drag force exerted by the fluid on the inner surface of the pipe becomes

$$F_D = \tau_w A_s = \frac{2\mu u_{\max}}{R} (2\pi RL) = 4\pi\mu L u_{\max}$$

(b) Substituting the values we get

$$F_D = 4\pi\mu L u_{\max} = 4\pi(0.0010 \text{ kg/m}\cdot\text{s})(30 \text{ m})(3 \text{ m/s}) \left( \frac{1 \text{ N}}{1 \text{ kg}\cdot\text{m/s}^2} \right) = \mathbf{1.13 \text{ N}}$$

**Discussion** In the entrance region and during turbulent flow, the velocity gradient is greater near the wall, and thus the drag force in such cases will be greater.

## 2-84

**Solution** The velocity profile for laminar one-dimensional flow through a circular pipe is given. A relation for friction drag force exerted on the pipe and its numerical value for water are to be determined.

**Assumptions** 1 The flow through the circular pipe is one-dimensional. 2 The fluid is Newtonian.

**Properties** The viscosity of water at 20°C is given to be 0.0010 kg/m·s.

**Analysis** (a) The velocity profile is given by  $u(r) = u_{\max} \left(1 - \frac{r^2}{R^2}\right)$

where  $R$  is the radius of the pipe,  $r$  is the radial distance from the center of the pipe, and  $u_{\max}$  is the maximum flow velocity, which occurs at the center,  $r = 0$ . The shear stress at the pipe surface can be expressed as

$$\tau_w = -\mu \left. \frac{du}{dr} \right|_{r=R} = -\mu u_{\max} \left. \frac{d}{dr} \left(1 - \frac{r^2}{R^2}\right) \right|_{r=R} = -\mu u_{\max} \left. \frac{-2r}{R^2} \right|_{r=R} = \frac{2\mu u_{\max}}{R}$$

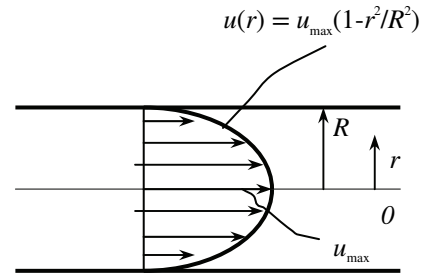

Note that the quantity  $du/dr$  is negative in pipe flow, and the negative sign is added to the  $\tau_w$  relation for pipes to make shear stress in the positive (flow) direction a positive quantity. (Or,  $du/dr = -du/dy$  since  $y = R - r$ ). Then the friction drag force exerted by the fluid on the inner surface of the pipe becomes

$$F_D = \tau_w A_s = \frac{2\mu u_{\max}}{R} (2\pi RL) = 4\pi\mu L u_{\max}$$

(b) Substituting, we get

$$F_D = 4\pi\mu L u_{\max} = 4\pi(0.0010 \text{ kg/m}\cdot\text{s})(30 \text{ m})(6 \text{ m/s}) \left( \frac{1 \text{ N}}{1 \text{ kg}\cdot\text{m/s}^2} \right) = 2.26 \text{ N}$$

**Discussion** In the entrance region and during turbulent flow, the velocity gradient is greater near the wall, and thus the drag force in such cases will be larger.

2-85

**Solution** A frustum shaped body is rotating at a constant angular speed in an oil container. The power required to maintain this motion and the reduction in the required power input when the oil temperature rises are to be determined.

**Assumptions** The thickness of the oil layer remains constant.

**Properties** The absolute viscosity of oil is given to be  $\mu = 0.1 \text{ Pa}\cdot\text{s} = 0.1 \text{ N}\cdot\text{s}/\text{m}^2$  at  $20^\circ\text{C}$  and  $0.0078 \text{ Pa}\cdot\text{s}$  at  $80^\circ\text{C}$ .

**Analysis** The velocity gradient anywhere in the oil of film thickness  $h$  is  $V/h$  where  $V = \omega r$  is the tangential velocity. Then the wall shear stress anywhere on the surface of the frustum at a distance  $r$  from the axis of rotation is

$$\tau_w = \mu \frac{du}{dr} = \mu \frac{V}{h} = \mu \frac{\omega r}{h}$$

The shear force acting on differential area  $dA$  on the surface, the torque it generates, and the shaft power associated with it are expressed as

$$dF = \tau_w dA = \mu \frac{\omega r}{h} dA \quad dT = r dF = \mu \frac{\omega r^2}{h} dA$$

$$T = \frac{\mu \omega}{h} \int_A r^2 dA \quad \dot{W}_{\text{sh}} = \omega T = \frac{\mu \omega^2}{h} \int_A r^2 dA$$

**Top surface:** For the top surface,  $dA = 2\pi r dr$ . Substituting and integrating,

$$\dot{W}_{\text{sh, top}} = \frac{\mu \omega^2}{h} \int_{r=0}^{D/2} r^2 (2\pi r) dr = \frac{2\pi \mu \omega^2}{h} \int_{r=0}^{D/2} r^3 dr = \frac{2\pi \mu \omega^2}{h} \frac{r^4}{4} \Big|_{r=0}^{D/2} = \frac{\pi \mu \omega^2 D^4}{32h}$$

**Bottom surface:** A relation for the bottom surface is obtained by replacing  $D$  by  $d$ ,  $\dot{W}_{\text{sh, bottom}} = \frac{\pi \mu \omega^2 d^4}{32h}$

**Side surface:** The differential area for the side surface can be expressed as  $dA = 2\pi r dz$ . From geometric considerations,

the variation of radius with axial distance is expressed as  $r = \frac{d}{2} + \frac{D-d}{2L} z$ .

Differentiating gives  $dr = \frac{D-d}{2L} dz$  or  $dz = \frac{2L}{D-d} dr$ . Therefore,  $dA = 2\pi dz = \frac{4\pi L}{D-d} r dr$ . Substituting and integrating,

$$\dot{W}_{\text{sh, side}} = \frac{\mu \omega^2}{h} \int_{r=d/2}^{D/2} r^2 \frac{4\pi L}{D-d} r dr = \frac{4\pi \mu \omega^2 L}{h(D-d)} \int_{r=d/2}^{D/2} r^3 dr = \frac{4\pi \mu \omega^2 L}{h(D-d)} \frac{r^4}{4} \Big|_{r=d/2}^{D/2} = \frac{\pi \mu \omega^2 L (D^2 - d^2)}{16h(D-d)}$$

Then the total power required becomes

$$\dot{W}_{\text{sh, total}} = \dot{W}_{\text{sh, top}} + \dot{W}_{\text{sh, bottom}} + \dot{W}_{\text{sh, side}} = \frac{\pi \mu \omega^2 D^4}{32h} \left[ 1 + (d/D)^4 + \frac{2L[1 - (d/D)^4]}{D-d} \right],$$

where  $d/D = 4/12 = 1/3$ . Substituting,

$$\dot{W}_{\text{sh, total}} = \frac{\pi(0.1 \text{ N}\cdot\text{s}/\text{m}^2)(200/\text{s})^2(0.12 \text{ m})^4}{32(0.0012 \text{ m})} \left[ 1 + (1/3)^4 + \frac{2(0.12 \text{ m})[1 - (1/3)^4]}{(0.12 - 0.04) \text{ m}} \right] \left( \frac{1 \text{ W}}{1 \text{ N}\cdot\text{m}/\text{s}} \right) = \mathbf{270 \text{ W}}$$

Noting that power is proportional to viscosity, the power required at  $80^\circ\text{C}$  is

$$\dot{W}_{\text{sh, total, } 80^\circ\text{C}} = \frac{\mu_{80^\circ\text{C}}}{\mu_{20^\circ\text{C}}} \dot{W}_{\text{sh, total, } 20^\circ\text{C}} = \frac{0.0078 \text{ N}\cdot\text{s}/\text{m}^2}{0.1 \text{ N}\cdot\text{s}/\text{m}^2} (270 \text{ W}) = 21.1 \text{ W}$$

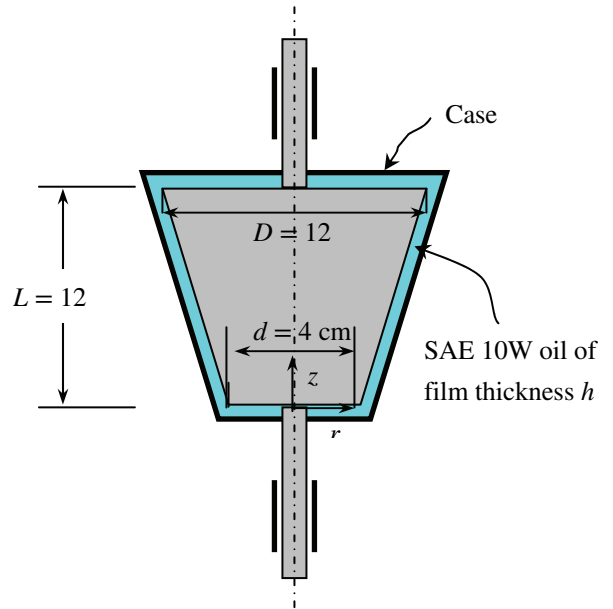

Therefore, the reduction in the required power input at 80°C is  $\text{Reduction} = \dot{W}_{\text{sh, total, } 20^\circ\text{C}} - \dot{W}_{\text{sh, total, } 80^\circ\text{C}} = 270 - 21.1 = 249 \text{ W}$ , which is about 92%.

**Discussion** Note that the power required to overcome shear forces in a viscous fluid greatly depends on temperature.

2-86

**Solution** We are to determine the torque required to rotate the outer cylinder of two concentric cylinders, with the outer cylinder rotating and the inner cylinder stationary.

**Assumptions** 1 The fluid is incompressible and Newtonian. 2 End effects (top and bottom) are negligible. 3 The gap is very small so that wall curvature effects are negligible. 4 The gap is so small that the velocity profile in the gap is linear.

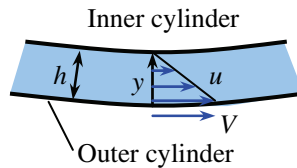

**Analysis** We assume a linear velocity profile between the two walls – the outer wall is moving at speed  $V = \omega_o R_o$  and the inner wall is stationary. The thickness of the gap is  $h$ , and we let  $y$  be the distance from the outer wall into the fluid (towards the inner wall) as sketched. Thus,

$$u = V \frac{h-y}{h} \quad \text{and} \quad \tau = \mu \frac{du}{dy} = -\mu \frac{V}{h}$$

where

$$h = R_o - R_i \quad \text{and} \quad V = \omega_o R_o$$

Since shear stress  $\tau$  has dimensions of force/area, the clockwise (mathematically negative) tangential force acting along the surface of the outer cylinder by the fluid is

$$F = -\tau A = -\mu \frac{V}{h} 2\pi R_o L = -\frac{\mu \omega_o R_o}{R_o - R_i} 2\pi R_o L$$

But the torque is the tangential force times the moment arm  $R_o$ . Also, we are asked for the torque required to turn the inner cylinder. This applied torque is counterclockwise (mathematically positive). Thus,

$$T = -FR_o = \frac{2\pi L \mu \omega_o R_o^3}{R_o - R_i} = \frac{2\pi L \mu \omega_o R_o^3}{h}$$

**Discussion** The above is only an approximation because we assumed a linear velocity profile. As long as the gap is very small, and therefore the wall curvature effects are negligible, this approximation should be very good. It is possible to solve for the exact velocity profile for this problem, and therefore the torque can be found analytically, but this has to wait until the differential analysis chapter.

2-87

**Solution** A thin flat plate is pulled horizontally through the mid plane of an oil layer sandwiched between two stationary plates. The force that needs to be applied on the plate to maintain this motion is to be determined for this case and for the case when the plate.

**Assumptions** 1 The thickness of the plate is negligible. 2 The velocity profile in each oil layer is linear.

**Properties** The absolute viscosity of oil is given to be  $\mu = 0.9 \text{ N}\cdot\text{s}/\text{m}^2$ .

**Analysis** The velocity profile in each oil layer relative to the fixed wall is as shown in the figure.

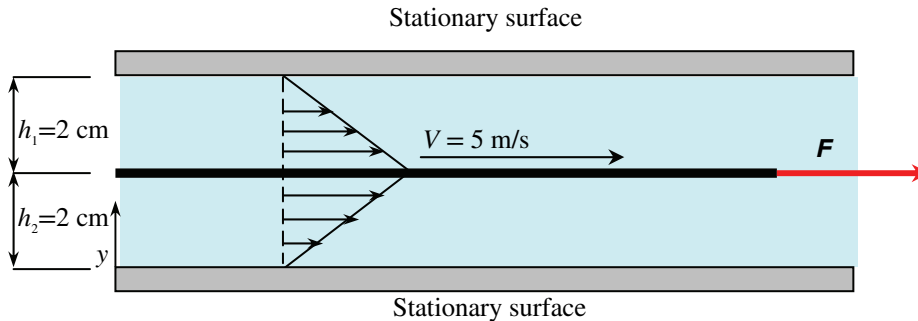

The magnitudes of shear forces acting on the upper and lower surfaces of the moving thin plate are

$$F_{\text{shear, upper}} = \tau_{w, \text{upper}} A_s = \mu A_s \left| \frac{du}{dy} \right| = \mu A_s \frac{V-0}{h_1} = (0.9 \text{ N}\cdot\text{s}/\text{m}^2)(0.5 \times 2 \text{ m}^2) \frac{5 \text{ m/s}}{0.02 \text{ m}} = 225 \text{ N}$$

$$F_{\text{shear, lower}} = \tau_{w, \text{lower}} A_s = \mu A_s \left| \frac{du}{dy} \right| = \mu A_s \frac{V-V_w}{h_2} = (0.9 \text{ N}\cdot\text{s}/\text{m}^2)(0.5 \times 2 \text{ m}^2) \frac{5 \text{ m/s}}{0.02 \text{ m}} = 225 \text{ N}$$

Noting that both shear forces are in the opposite direction of motion of the plate, the force  $F$  is determined from a force balance on the plate to be

$$F = F_{\text{shear, upper}} + F_{\text{shear, lower}} = 225 + 225 = \mathbf{450 \text{ N}}$$

When the plate is 1 cm from the bottom surface and 3 cm from the top surface, the force  $F$  becomes

$$F_{\text{shear, upper}} = \tau_{w, \text{upper}} A_s = \mu A_s \left| \frac{du}{dy} \right| = \mu A_s \frac{V-0}{h_1} = (0.9 \text{ N}\cdot\text{s}/\text{m}^2)(0.5 \times 2 \text{ m}^2) \frac{5 \text{ m/s}}{0.03 \text{ m}} = 150 \text{ N}$$

$$F_{\text{shear, lower}} = \tau_{w, \text{lower}} A_s = \mu A_s \left| \frac{du}{dy} \right| = \mu A_s \frac{V-0}{h_2} = (0.9 \text{ N}\cdot\text{s}/\text{m}^2)(0.5 \times 2 \text{ m}^2) \frac{5 \text{ m/s}}{0.01 \text{ m}} = 450 \text{ N}$$

Noting that both shear forces are in the opposite direction of motion of the plate, the force  $F$  is determined from a force balance on the plate to be

$$F = F_{\text{shear, upper}} + F_{\text{shear, lower}} = 150 + 450 = \mathbf{600 \text{ N}}$$

**Discussion** Note that the relative location of the thin plate affects the required force significantly.



2-88

**Solution** A thin flat plate is pulled horizontally through the mid plane of an oil layer sandwiched between two stationary plates. The force that needs to be applied on the plate to maintain this motion is to be determined for this case and for the case when the plate .

**Assumptions** 1 The thickness of the plate is negligible. 2 The velocity profile in each oil layer is linear.

**Properties** The absolute viscosity of oil is  $\mu = 0.9 \text{ N}\cdot\text{s}/\text{m}^2$  in the lower part, and 4 times that in the upper part.

**Analysis** We measure vertical distance  $y$  from the lower plate. The total distance between the stationary plates is  $h = h_1 + h_2 = 4 \text{ cm}$ , which is constant. Then the distance of the moving plate is  $y$  from the lower plate and  $h - y$  from the upper plate, where  $y$  is variable.

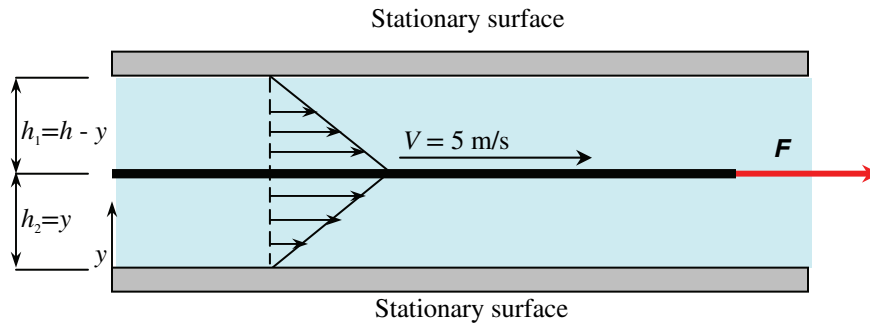

The shear forces acting on the upper and lower surfaces of the moving thin plate are

$$F_{\text{shear, upper}} = \tau_{w, \text{upper}} A_s = \mu_{\text{upper}} A_s \left. \frac{du}{dy} \right| = \mu_{\text{upper}} A_s \frac{V}{h - y}$$

$$F_{\text{shear, lower}} = \tau_{w, \text{lower}} A_s = \mu_{\text{lower}} A_s \left. \frac{du}{dy} \right| = \mu_{\text{lower}} A_s \frac{V}{y}$$

Then the total shear force acting on the plate becomes

$$F = F_{\text{shear, upper}} + F_{\text{shear, lower}} = \mu_{\text{upper}} A_s \frac{V}{h - y} + \mu_{\text{lower}} A_s \frac{V}{y} = A_s V \left( \frac{\mu_{\text{upper}}}{h - y} + \frac{\mu_{\text{lower}}}{y} \right)$$

The value of  $y$  that will minimize the force  $F$  is determined by setting  $\frac{dF}{dy} = 0$ :

$$\frac{\mu_{\text{upper}}}{(h - y)^2} - \frac{\mu_{\text{lower}}}{y^2} = 0 \quad \rightarrow \quad \frac{y}{h - y} = \sqrt{\frac{\mu_{\text{lower}}}{\mu_{\text{upper}}}}$$

Solving for  $y$  and substituting, the value of  $y$  that minimizes the shear force is determined to be

$$y = \frac{\sqrt{\mu_{\text{lower}} / \mu_{\text{upper}}}}{1 - \sqrt{\mu_{\text{lower}} / \mu_{\text{upper}}}} h = \frac{\sqrt{1/4}}{1 - \sqrt{1/4}} (4 \text{ cm}) = \mathbf{1 \text{ cm}}$$

**Discussion** By showing that  $\frac{d^2 F}{dy^2} > 0$  at  $y = 1 \text{ cm}$ , it can be verified that  $F$  is indeed a minimum at that location and not a maximum.

## 2-89

**Solution** A cylinder slides down from rest in a vertical tube whose inner surface is covered by oil. An expression for the velocity of the cylinder as a function of time is to be derived.

**Assumptions** 1 Velocity profile in the oil film is linear.

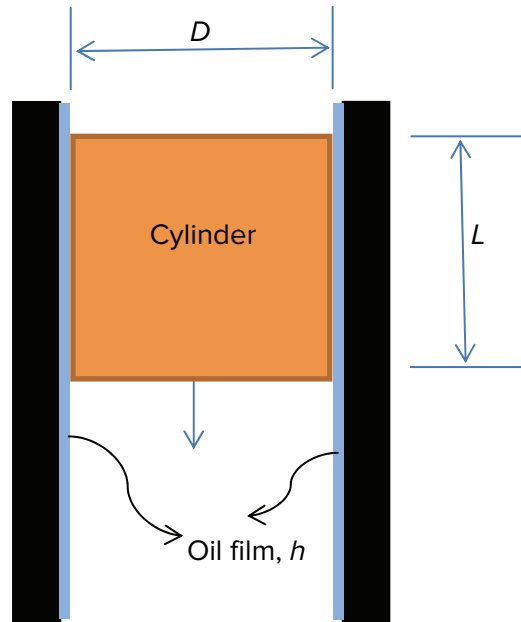

**Analysis** Assuming a linear velocity profile in the oil film the drag force due to wall shear stress can be expressed as

$$F_D = \mu \frac{dV}{dy} A = \mu \frac{V}{h} \pi DL = kV$$

where  $V$  is the instantaneous velocity of the cylinder and

$$k = \mu \frac{\pi DL}{h}$$

Applying Newton's second law of motion for the cylinder, we write

$$mg - kV = m \frac{dV}{dt}$$

where  $t$  is the time. This is a first-order linear equation and can be expressed in standard form as follows:

$$\frac{dV}{dt} + \frac{k}{m}V = g \quad \text{with} \quad V(0) = 0$$

whose solution is obtained to be

$$V(t) = \frac{mg}{k} (1 - e^{-(k/m)t})$$

As  $t \rightarrow \infty$  the second term will vanish leaving us with

$$V(t) = \frac{mg}{k}$$

which is constant. This constant is referred to as "limit velocity  $V_L$ ". Rearranging for viscosity, we have

$$\mu = \frac{mgh}{\pi DLV_L}$$

2-58

Therefore this equation enables us to estimate dynamic viscosity of oil provided that the limit velocity of the cylinder is precisely measured.

---

---

**Surface Tension and Capillary Effect**

---

**2-90C**

**Solution** We are to define and discuss surface tension.

**Analysis** The **magnitude of the pulling force at the surface of a liquid per unit length** is called *surface tension*  $\sigma_s$ . It is caused by the attractive forces between the molecules. The surface tension is also surface energy (per unit area) since it represents the stretching work that needs to be done to increase the surface area of the liquid by a unit amount.

**Discussion** Surface tension is the cause of some very interesting phenomena such as capillary rise and insects that can walk on water.

---

---

**2-91C**

**Solution** We are to define and discuss the capillary effect.

**Analysis** The *capillary effect* is the **rise or fall of a liquid in a small-diameter tube inserted into the liquid**. It is caused by the net effect of the *cohesive forces* (the forces between like molecules, like water) and *adhesive forces* (the forces between unlike molecules, like water and glass). **The capillary effect is proportional to the cosine of the contact angle**, which is the angle that the tangent to the liquid surface makes with the solid surface at the point of contact.

**Discussion** The contact angle determines whether the *meniscus* at the top of the column is concave or convex.

---

---

**2-92C**

**Solution** We are to determine whether the level of liquid in a tube will rise or fall due to the capillary effect.

**Analysis** The **liquid level in the tube will drop** since the contact angle is greater than  $90^\circ$ , and  $\cos(110^\circ) < 0$ .

**Discussion** This liquid must be a non-wetting liquid when in contact with the tube material. Mercury is an example of a non-wetting liquid with a contact angle (with glass) that is greater than  $90^\circ$ .

---

---

## 2-93C

**Solution** We are to analyze the pressure difference between inside and outside of a soap bubble.

**Analysis** The **pressure inside a soap bubble is greater than the pressure outside**, as evidenced by the stretch of the soap film.

**Discussion** You can make an analogy between the soap film and the skin of a balloon.

---

## 2-94C

**Solution** We are to compare the capillary rise in small and large diameter tubes.

**Analysis** The capillary rise is inversely proportional to the diameter of the tube, and thus **capillary rise is greater in the smaller-diameter tube**.

**Discussion** Note however, that if the tube diameter is large enough, there is no capillary rise (or fall) at all. Rather, the upward (or downward) rise of the liquid occurs only near the tube walls; the elevation of the middle portion of the liquid in the tube does not change for large diameter tubes.

---

## 2-95

**Solution** The diameter of a soap bubble is given. The gage pressure inside the bubble is to be determined.

**Assumptions** The soap bubble is in atmospheric air.

**Properties** The surface tension of soap water at 20°C is  $\sigma_s = 0.025$  N/m.

**Analysis** The pressure difference between the inside and the outside of a bubble is given by

$$\Delta P_{\text{bubble}} = P_i - P_o = \frac{4\sigma_s}{R}$$

In the open atmosphere  $P_o = P_{\text{atm}}$ , and thus  $\Delta P_{\text{bubble}}$  is equivalent to the gage pressure. Substituting,

$$D = 0.200 \text{ cm: } P_{i,\text{gage}} = \Delta P_{\text{bubble}} = \frac{4(0.025 \text{ N/m})}{(0.00200/2) \text{ m}} = 100 \text{ N/m}^2 = 100 \text{ Pa}$$

$$D = 5.00 \text{ cm: } P_{i,\text{gage}} = \Delta P_{\text{bubble}} = \frac{4(0.025 \text{ N/m})}{(0.0500/2) \text{ m}} = 4 \text{ N/m}^2 = 4 \text{ Pa}$$

**Discussion** Note that the gage pressure in a soap bubble is inversely proportional to the radius (or diameter). Therefore, the excess pressure is larger in smaller bubbles.

---

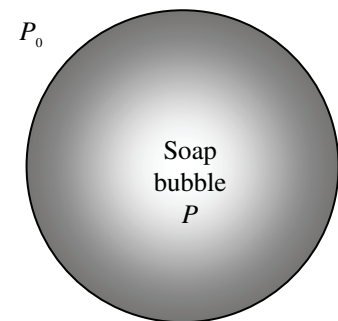

## 2-96E

**Solution** A soap bubble is enlarged by blowing air into it. The required work input is to be determined.

**Properties** The surface tension of solution is given to be  $\sigma_s = 0.0027$  lbf/ft.

**Analysis** The work associated with the stretching of a film is the surface tension work, and is expressed in differential form as  $\delta W_s = \sigma_s dA_s$ . Noting that surface tension is constant, the surface tension work is simply surface tension multiplied by the change in surface area,

$$W_s = \sigma_s (A_2 - A_1) = 2\pi\sigma_s (D_2^2 - D_1^2)$$

The factor 2 is due to having two surfaces in contact with air. Substituting, the required work input is determined to be

$$W_s = 2\pi(0.0027 \text{ lbf/ft}) \left( (2.7/12 \text{ ft})^2 - (2.4/12 \text{ ft})^2 \right) \left( \frac{1 \text{ Btu}}{778.169 \text{ lbf} \cdot \text{ft}} \right) = \mathbf{2.32 \times 10^{-7} \text{ Btu}}$$

**Discussion** Note that when a bubble explodes, an equivalent amount of energy is released to the environment.

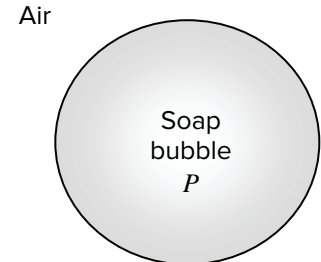

## 2-97

**Solution** A glass tube is inserted into a liquid, and the capillary rise is measured. The surface tension of the liquid is to be determined.

**Assumptions** 1 There are no impurities in the liquid, and no contamination on the surfaces of the glass tube. 2 The liquid is open to the atmospheric air.

**Properties** The density of the liquid is given to be  $960 \text{ kg/m}^3$ . The contact angle is given to be  $15^\circ$ .

**Analysis** Substituting the numerical values, the surface tension is determined from the capillary rise relation to be

$$\begin{aligned} \sigma_s &= \frac{\rho g R h}{2 \cos \phi} \\ &= \frac{(960 \text{ kg/m}^3)(9.81 \text{ m/s}^2)(0.0016/2 \text{ m})(0.005 \text{ m})}{2(\cos 15^\circ)} \left( \frac{1 \text{ N}}{1 \text{ kg} \cdot \text{m/s}^2} \right) \\ &= \mathbf{0.0195 \text{ N/m}} \end{aligned}$$

**Discussion** Since surface tension depends on temperature, the value determined is valid at the liquid's temperature.

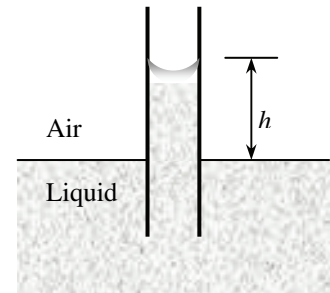

2-98

**Solution** An air bubble in a liquid is considered. The pressure difference between the inside and outside the bubble is to be determined.

**Properties** The surface tension  $\sigma_s$  is given for two cases to be 0.08 and 0.12 N/m.

**Analysis** Considering that an air bubble in a liquid has only one interface, the pressure difference between the inside and the outside of the bubble is determined from

$$\Delta P_{\text{bubble}} = P_i - P_o = \frac{2\sigma_s}{R}$$

Substituting, the pressure difference is determined to be:

(a)  $\sigma_s = 0.08 \text{ N/m}$ :  $\Delta P_{\text{bubble}} = \frac{2(0.08 \text{ N/m})}{0.00015/2 \text{ m}} = 2133 \text{ N/m}^2 = \mathbf{2.13 \text{ kPa}}$

(b)  $\sigma_s = 0.12 \text{ N/m}$ :  $\Delta P_{\text{bubble}} = \frac{2(0.12 \text{ N/m})}{0.00015/2 \text{ m}} = 3200 \text{ N/m}^2 = \mathbf{3.20 \text{ kPa}}$

**Discussion** Note that a small gas bubble in a liquid is highly pressurized. The smaller the bubble diameter, the larger the pressure inside the bubble.

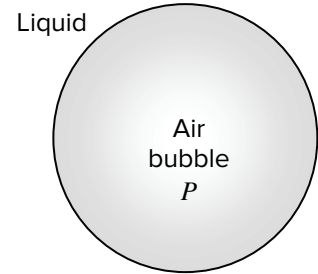

2-99

**Solution** The force acting on the movable wire of a liquid film suspended on a U-shaped wire frame is measured. The surface tension of the liquid in the air is to be determined.

**Assumptions** 1 There are no impurities in the liquid, and no contamination on the surfaces of the wire frame. 2 The liquid is open to the atmospheric air.

**Analysis** Substituting the numerical values, the surface tension is determined from the surface tension force relation to be

$$\sigma_s = \frac{F}{2b} = \frac{0.030 \text{ N}}{2(0.08 \text{ m})} = \mathbf{0.19 \text{ N/m}}$$

**Discussion** The surface tension depends on temperature. Therefore, the value determined is valid at the temperature of the liquid.

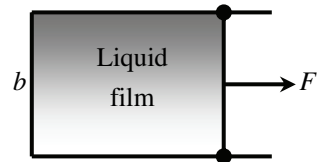

**2-100**

**Solution** A capillary tube is immersed vertically in water. The height of water rise in the tube is to be determined.

**Assumptions** **1** There are no impurities in water, and no contamination on the surfaces of the tube. **2** Water is open to the atmospheric air.

**Analysis** The capillary rise is determined from Eq. 2-38 to be

$$h = \frac{2\sigma_s}{\rho g R} \cos \phi = \frac{2 \times (1 \text{ N/m}) \times \cos 6^\circ}{(1000 \text{ kg/m}^3) \times (9.81 \text{ m/s}^2) \times (0.6 \times 10^{-3} \text{ m})} = 0.338 \text{ m}$$

**2-101E**

**Solution** A glass tube is inserted into mercury. The capillary drop of mercury in the tube is to be determined.

**Assumptions** **1** There are no impurities in mercury, and no contamination on the surfaces of the glass tube. **2** The mercury is open to the atmospheric air.

**Properties** The surface tension of mercury-glass in atmospheric air at 68°F (20°C) is obtained from Table 2-4:  $\sigma_s = (0.440 \text{ N/m})(0.22482 \text{ lbf/N})(0.3048 \text{ m/ft}) = 0.030151 \text{ lbf/ft}$ . To obtain the density of mercury, we interpolate from Table A-8E at 68°F, yielding  $\rho = 845.65 \text{ lbf/ft}^3$ . The contact angle is given to be 140°.

**Analysis** Substituting the numerical values, the capillary drop is determined to be

$$h = \frac{2\sigma_s \cos \phi}{\rho g R} = \frac{2(0.030151 \text{ lbf/ft})(\cos 140^\circ)}{(845.65 \text{ lbf/ft}^3)(32.174 \text{ ft/s}^2)(0.009/12) \text{ ft}} \left( \frac{32.174 \text{ lbf} \cdot \text{ft/s}^2}{1 \text{ lbf}} \right)$$

$$= -0.072834 \text{ ft} = -0.87401 \text{ in}$$

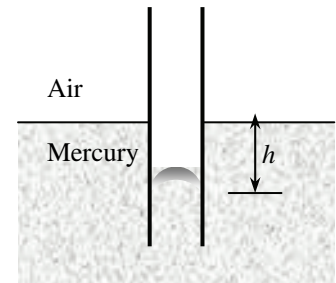

Thus, the capillary drop is **0.874 in** to three significant digits.

**Discussion** The negative sign indicates capillary drop instead of rise. The drop is very small in this case because of the large diameter of the tube.



## 2-102

**Solution** A capillary tube is immersed vertically in water. The maximum capillary rise and tube diameter for the maximum rise case are to be determined.

**Assumptions** 1 There are no impurities in water, and no contamination on the surfaces of the tube. 2 Water is open to the atmospheric air.

**Properties** The surface tension is given to be  $\sigma_s = 1 \text{ N/m}$ .

**Analysis** At the liquid side of the meniscus  $P = 2 \text{ kPa}$ . Therefore the capillary rise would be

$$h = \frac{P_{\text{atm}} - P}{\rho g} = \frac{(101325 - 2000) \times 10^3 \text{ Pa}}{(1000 \text{ kg/m}^3) \times (9.81 \text{ m/s}^2)} = 10.12 \text{ m}$$

Then the tube diameter needed for this capillary rise is

$$R = \frac{2\sigma_s \cos \varnothing}{\rho g h} = \frac{2 \times (1 \text{ N/m}) \times \cos 6^\circ}{(1000 \text{ kg/m}^3) \times (9.81 \text{ m/s}^2) \times (10.12 \text{ m})} \cong 2.0 \times 10^{-5} \text{ m} = \mathbf{20 \mu\text{m}}$$



---

## 2-103

**Solution** A steel ball floats on water due to the surface tension effect. The maximum diameter of the ball is to be determined, and the calculations are to be repeated for aluminum.

**Assumptions** **1** The water is pure, and its temperature is constant. **2** The ball is dropped on water slowly so that the inertial effects are negligible. **3** The contact angle is taken to be  $0^\circ$  for maximum diameter.

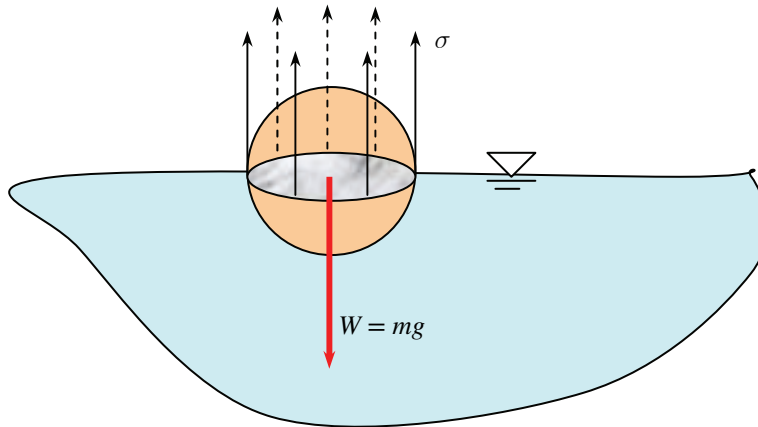
**Properties** The surface tension of water at  $10^\circ\text{C}$  is  $\sigma_s = 0.0745 \text{ N/m}$  (Table 2-4 by interpolation). The contact angle is taken to be  $0^\circ$ . The densities of steel and aluminum are given to be  $\rho_{\text{steel}} = 7800 \text{ kg/m}^3$  and  $\rho_{\text{Al}} = 2700 \text{ kg/m}^3$ .



**Analysis** The surface tension force and the weight of the ball can be expressed as

$$F_s = \pi D \sigma_s \quad \text{and} \quad W = mg = \rho g V = \rho g \pi D^3 / 6$$

When the ball floats, the net force acting on the ball in the vertical direction is zero. Therefore, setting  $F_s = W$  and solving for diameter  $D$  gives  $D = \sqrt{\frac{6\sigma_s}{\rho g}}$ . Substituting the known quantities, the maximum diameters for the steel and aluminum balls become

$$D_{\text{steel}} = \sqrt{\frac{6\sigma_s}{\rho g}} = \sqrt{\frac{6(0.0745 \text{ N/m})}{(7800 \text{ kg/m}^3)(9.81 \text{ m/s}^2)} \left( \frac{1 \text{ kg} \cdot \text{m/s}^2}{1 \text{ N}} \right)} = 2.42 \times 10^{-3} \text{ m} = \mathbf{2.42 \text{ mm}}$$

$$D_{\text{Al}} = \sqrt{\frac{6\sigma_s}{\rho g}} = \sqrt{\frac{6(0.0745 \text{ N/m})}{(2700 \text{ kg/m}^3)(9.81 \text{ m/s}^2)} \left( \frac{1 \text{ kg} \cdot \text{m/s}^2}{1 \text{ N}} \right)} = 4.11 \times 10^{-3} \text{ m} = \mathbf{4.11 \text{ mm}}$$

**Discussion** Note that the ball diameter is inversely proportional to the square root of density, and thus for a given material, the smaller balls are more likely to float.

## 2-104

**Solution** Nutrients dissolved in water are carried to upper parts of plants. The height to which the water solution rises in a tree as a result of the capillary effect is to be determined.

**Assumptions** 1 The solution can be treated as water with a contact angle of  $15^\circ$ . 2 The diameter of the tube is constant. 3 The temperature of the water solution is  $20^\circ\text{C}$ .

**Properties** The surface tension of water at  $20^\circ\text{C}$  is  $\sigma_s = 0.073 \text{ N/m}$ . The density of water solution can be taken to be  $1000 \text{ kg/m}^3$ . The contact angle is given to be  $15^\circ$ .

**Analysis** Substituting the numerical values, the capillary rise is determined to be

$$h = \frac{2\sigma_s \cos\phi}{\rho g R} = \frac{2(0.073 \text{ N/m})(\cos 15^\circ)}{(1000 \text{ kg/m}^3)(9.81 \text{ m/s}^2)(1.3 \times 10^{-6} \text{ m})} \left( \frac{1 \text{ kg} \cdot \text{m/s}^2}{1 \text{ N}} \right) = \mathbf{11.1 \text{ m}}$$

**Discussion** Other effects such as the chemical potential difference also cause the fluid to rise in trees.

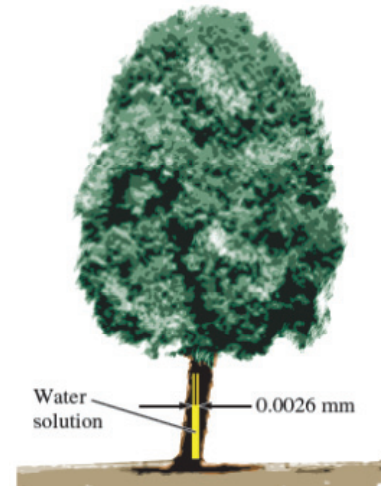

---

**Review Problems**



---

**2-105**

**Solution** A journal bearing is lubricated with oil whose viscosity is known. The torques needed to overcome the bearing friction during start-up and steady operation are to be determined.

**Assumptions** 1 The gap is uniform, and is completely filled with oil. 2 The end effects on the sides of the bearing are negligible. 3 The fluid is Newtonian.

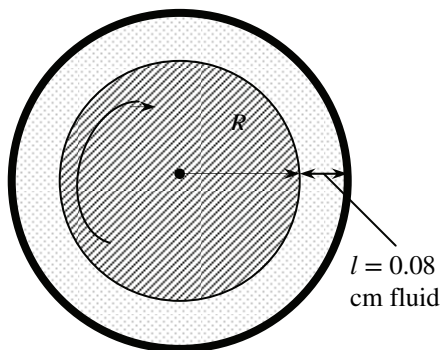
**Properties** The viscosity of oil is given to be 0.1 kg/m·s at 20°C, and 0.008 kg/m·s at 80°C.



**Analysis** The radius of the shaft is  $R = 0.04$  m. Substituting the given values, the torque is determined to be

At start up at 20°C:

$$\mathbf{T} = \mu \frac{4\pi^2 R^3 \dot{n}L}{\ell} = (0.1 \text{ kg/m}\cdot\text{s}) \frac{4\pi^2 (0.04 \text{ m})^3 (1500/60 \text{ s}^{-1})(0.55 \text{ m})}{0.0008 \text{ m}} = \mathbf{4.34 \text{ N}\cdot\text{m}}$$

During steady operation at 80°C:

$$\mathbf{T} = \mu \frac{4\pi^2 R^3 \dot{n}L}{\ell} = (0.008 \text{ kg/m}\cdot\text{s}) \frac{4\pi^2 (0.04 \text{ m})^3 (1500/60 \text{ s}^{-1})(0.55 \text{ m})}{0.0008 \text{ m}} = \mathbf{0.347 \text{ N}\cdot\text{m}}$$

**Discussion** Note that the torque needed to overcome friction reduces considerably due to the decrease in the viscosity of oil at higher temperature.

---

## 2-106

**Solution** A U-tube with a large diameter arm contains water. The difference between the water levels of the two arms is to be determined.

**Assumptions** 1 Both arms of the U-tube are open to the atmosphere. 2 Water is at room temperature. 3 The contact angle of water is zero,  $\phi = 0$ .

**Properties** The surface tension and density of water at 20°C are  $\sigma_s = 0.073 \text{ N/m}$  and  $\rho = 1000 \text{ kg/m}^3$ .

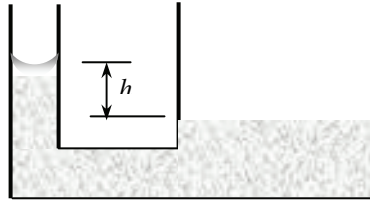

**Analysis** Any difference in water levels between the two arms is due to surface tension effects and thus capillary rise. Noting that capillary rise in a tube is inversely proportional to tube diameter there will be no capillary rise in the arm with a large diameter. Then the water level difference between the two arms is simply the capillary rise in the smaller diameter arm,

$$h = \frac{2\sigma_s \cos \phi}{\rho g R} = \frac{2(0.073 \text{ N/m})(\cos 0^\circ)}{(1000 \text{ kg/m}^3)(9.81 \text{ m/s}^2)(0.0025 \text{ m})} \left( \frac{1 \text{ kg} \cdot \text{m/s}^2}{1 \text{ N}} \right) \left( \frac{1000 \text{ mm}}{1 \text{ m}} \right) = \mathbf{5.95 \text{ mm}}$$

**Discussion** Note that this is a significant difference, and shows the importance of using a U-tube made of a uniform diameter tube.

## 2-107E

**Solution** A rigid tank contains slightly pressurized air. The amount of air that needs to be added to the tank to raise its pressure and temperature to the recommended values is to be determined.

**Assumptions** 1 At specified conditions, air behaves as an ideal gas. 2 The volume of the tank remains constant.

**Properties** The gas constant of air is  $R_u = 53.34 \frac{\text{ft} \cdot \text{lbf}}{\text{lbm} \cdot \text{R}} \left( \frac{1 \text{ psia}}{144 \text{ lbf/ft}^2} \right) = 0.3794 \frac{\text{psia} \cdot \text{ft}^3}{\text{lbm} \cdot \text{R}}$ . The air temperature is  $70^\circ\text{F} = 70 + 459.67 = 529.67 \text{ R}$

**Analysis** Treating air as an ideal gas, the initial volume and the final mass in the tank are determined to be

$$V = \frac{m_1 R T_1}{P_1} = \frac{(40 \text{ lbm})(0.3794 \text{ psia} \cdot \text{ft}^3/\text{lbm} \cdot \text{R})(529.67 \text{ R})}{20 \text{ psia}} = 392.380 \text{ ft}^3$$

$$m_2 = \frac{P_2 V}{R T_2} = \frac{(35 \text{ psia})(392.380 \text{ ft}^3)}{(0.3794 \text{ psia} \cdot \text{ft}^3/\text{lbm} \cdot \text{R})(550 \text{ R})} = 67.413 \text{ lbm}$$

Thus the amount of air added is

$$\Delta m = m_2 - m_1 = 67.413 - 40.0 = 27.413 \text{ lbm} \cong \mathbf{27.4 \text{ lbm}}$$

Air, 40 lbm  
20 psia  
70°F

**Discussion** As the temperature slowly decreases due to heat transfer, the pressure will also decrease.

## 2-108

**Solution** A large tank contains nitrogen at a specified temperature and pressure. Now some nitrogen is allowed to escape, and the temperature and pressure of nitrogen drop to new values. The amount of nitrogen that has escaped is to be determined.

**Assumptions** The tank is insulated so that no heat is transferred.

**Analysis** Treating  $N_2$  as an ideal gas, the initial and the final masses in the tank are determined to be

$$m_1 = \frac{P_1 V}{RT_1} = \frac{(800 \text{ kPa})(10 \text{ m}^3)}{(0.2968 \text{ kPa} \cdot \text{m}^3/\text{kg} \cdot \text{K})(298 \text{ K})} = 90.45 \text{ kg}$$

$$m_2 = \frac{P_2 V}{RT_2} = \frac{(600 \text{ kPa})(10 \text{ m}^3)}{(0.2968 \text{ kPa} \cdot \text{m}^3/\text{kg} \cdot \text{K})(293 \text{ K})} = 69.00 \text{ kg}$$

Thus the amount of  $N_2$  that escaped is  $\Delta m = m_1 - m_2 = 90.45 - 69.00 = \mathbf{21.5 \text{ kg}}$

**Discussion** Gas expansion generally causes the temperature to drop. This principle is used in some types of refrigeration.

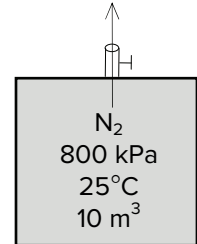

## 2-109

**Solution** The pressure in an automobile tire increases during a trip while its volume remains constant. The percent increase in the absolute temperature of the air in the tire is to be determined.

**Assumptions** 1 The volume of the tire remains constant. 2 Air is an ideal gas.

**Analysis** Noting that air is an ideal gas and the volume is constant, the ratio of absolute temperatures after and before the trip are

$$\frac{P_1 V_1}{T_1} = \frac{P_2 V_2}{T_2} \rightarrow \frac{T_2}{T_1} = \frac{P_2}{P_1} = \frac{335 \text{ kPa}}{320 \text{ kPa}} = 1.047$$

Therefore, the absolute temperature of air in the tire will increase by **4.7%** during this trip.

**Discussion** This may not seem like a large temperature increase, but if the tire is originally at  $20^\circ\text{C}$  ( $293.15 \text{ K}$ ), the temperature increases to  $1.047(293.15 \text{ K}) = 306.92 \text{ K}$  or about  $33.8^\circ\text{C}$ .

**2-110E**

**Solution** The minimum pressure in a pump is given. It is to be determined if there is a danger of cavitation.

**Properties** The vapor pressure of water at 60°F is 0.2563 psia.

**Analysis** To avoid cavitation, the pressure everywhere in the flow should remain above the vapor (or saturation) pressure at the given temperature, which is

$$P_v = P_{\text{sat}@60^\circ\text{F}} = 0.2563 \text{ psia}$$

The minimum pressure in the pump is 0.1 psia, which is less than the vapor pressure. Therefore, **there is danger of cavitation in the pump.**

**Discussion** Note that the vapor pressure increases with increasing temperature, and the danger of cavitation increases at higher fluid temperatures.

---

**2-111**

**Solution** Air in a partially filled closed water tank is evacuated. The absolute pressure in the evacuated space is to be determined.

**Properties** The saturation pressure of water at 70°C is 31.19 kPa.

**Analysis** When air is completely evacuated, the vacated space is filled with water vapor, and the tank contains a saturated water-vapor mixture at the given pressure. Since we have a two-phase mixture of a pure substance at a specified temperature, the vapor pressure must be the saturation pressure at this temperature. That is,

$$P_v = P_{\text{sat}@70^\circ\text{C}} = 31.19 \text{ kPa} \cong \mathbf{31.2 \text{ kPa}}$$

**Discussion** If there is any air left in the container, the vapor pressure will be less. In that case the sum of the component pressures of vapor and air would equal 31.19 kPa.

---

## 2-112

**Solution** The specific gravities of solid particles and carrier fluids of a slurry are given. The relation for the specific gravity of the slurry is to be obtained in terms of the mass fraction  $C_{s, \text{mass}}$  and the specific gravity  $SG_s$  of solid particles.

**Assumptions** **1** The solid particles are distributed uniformly in water so that the solution is homogeneous. **2** The effect of dissimilar molecules on each other is negligible.

**Analysis** Consider solid particles of mass  $m_s$  and volume  $\mathcal{V}_s$  dissolved in a fluid of mass  $m_f$  and volume  $\mathcal{V}_f$ . The total volume of the suspension (or mixture) is  $\mathcal{V}_m = \mathcal{V}_s + \mathcal{V}_f$ .

Dividing by  $\mathcal{V}_m$  gives

$$1 = \frac{\mathcal{V}_s}{\mathcal{V}_m} + \frac{\mathcal{V}_f}{\mathcal{V}_m} \rightarrow \frac{\mathcal{V}_f}{\mathcal{V}_m} = 1 - \frac{\mathcal{V}_s}{\mathcal{V}_m} = 1 - \frac{m_s / \rho_s}{m_m / \rho_m} = 1 - \frac{m_s}{m_m} \frac{\rho_m}{\rho_s} = 1 - C_{s, \text{mass}} \frac{SG_m}{SG_s} \quad (1)$$

since ratio of densities is equal two the ratio of specific gravities, and  $m_s / m_m = C_{s, \text{mass}}$ . The total mass of the suspension (or mixture) is  $m_m = m_s + m_f$ . Dividing by  $m_m$  and using the definition  $C_{s, \text{mass}} = m_s / m_m$  give

$$1 = C_{s, \text{mass}} + \frac{m_f}{m_m} = C_{s, \text{mass}} + \frac{\rho_f \mathcal{V}_f}{\rho_m \mathcal{V}_m} \rightarrow \frac{\rho_m}{\rho_f} = \frac{\mathcal{V}_f}{(1 - C_{s, \text{mass}}) \mathcal{V}_m} \quad (2)$$

Taking the fluid to be water so that  $\rho_m / \rho_f = SG_m$  and combining equations 1 and 2 give

$$SG_m = \frac{1 - C_{s, \text{mass}} SG_m / SG_s}{1 - C_{s, \text{mass}}}$$

Solving for  $SG_m$  and rearranging gives

$$\boxed{SG_m = \frac{1}{1 + C_{s, \text{mass}} (1/SG_s - 1)}}$$

which is the desired result.

**Discussion** As a quick check, if there were no particles at all,  $SG_m = 0$ , as expected.

## 2-113

**Solution** A rigid tank contains an ideal gas at a specified state. The final temperature when half the mass is withdrawn and final pressure when no mass is withdrawn are to be determined.

**Analysis** (a) The first case is a constant volume process. When half of the gas is withdrawn from the tank, the final temperature may be determined from the ideal gas relation as

$$T_2 = \frac{m_1}{m_2} \frac{P_2}{P_1} T_1 = (2) \left( \frac{100 \text{ kPa}}{300 \text{ kPa}} \right) (600 \text{ K}) = \mathbf{400 \text{ K}}$$

(b) The second case is a constant volume and constant mass process. The ideal gas relation for this case yields

$$P_2 = \frac{T_2}{T_1} P_1 = \left( \frac{400 \text{ K}}{600 \text{ K}} \right) (300 \text{ kPa}) = \mathbf{200 \text{ kPa}}$$

<p>Ideal gas 300 kPa 600 K</p>
--

**Discussion** Note that some forms of the ideal gas equation are more convenient to use than the other forms.



## 2-114

**Solution** Suspended solid particles in water are considered. A relation is to be developed for the specific gravity of the suspension in terms of the mass fraction  $C_{s, \text{mass}}$  and volume fraction  $C_{s, \text{vol}}$  of the particles.

**Assumptions** **1** The solid particles are distributed uniformly in water so that the solution is homogeneous. **2** The effect of dissimilar molecules on each other is negligible.

**Analysis** Consider solid particles of mass  $m_s$  and volume  $\mathcal{V}_s$  dissolved in a fluid of mass  $m_f$  and volume  $\mathcal{V}_f$ . The total volume of the suspension (or mixture) is

$$\mathcal{V}_m = \mathcal{V}_s + \mathcal{V}_f$$

Dividing by  $\mathcal{V}_m$  and using the definition  $C_{s, \text{vol}} = \mathcal{V}_s / \mathcal{V}_m$  give

$$1 = C_{s, \text{vol}} + \frac{\mathcal{V}_f}{\mathcal{V}_m} \quad \rightarrow \quad \frac{\mathcal{V}_f}{\mathcal{V}_m} = 1 - C_{s, \text{vol}} \quad (1)$$

The total mass of the suspension (or mixture) is

$$m_m = m_s + m_f$$

Dividing by  $m_m$  and using the definition  $C_{s, \text{mass}} = m_s / m_m$  give

$$1 = C_{s, \text{mass}} + \frac{m_f}{m_m} = C_{s, \text{mass}} + \frac{\rho_f \mathcal{V}_f}{\rho_m \mathcal{V}_m} \quad \rightarrow \quad \frac{\rho_f}{\rho_m} = (1 - C_{s, \text{mass}}) \frac{\mathcal{V}_m}{\mathcal{V}_f} \quad (2)$$

Combining equations 1 and 2 gives

$$\frac{\rho_f}{\rho_m} = \frac{1 - C_{s, \text{mass}}}{1 - C_{s, \text{vol}}}$$

When the fluid is water, the ratio  $\rho_f / \rho_m$  is the inverse of the definition of specific gravity. Therefore, the desired relation for the specific gravity of the mixture is

$$\boxed{\text{SG}_m = \frac{\rho_m}{\rho_f} = \frac{1 - C_{s, \text{vol}}}{1 - C_{s, \text{mass}}}}$$

which is the desired result.

**Discussion** As a quick check, if there were no particles at all,  $\text{SG}_m = 0$ , as expected.

---

2-115 

**Solution** The variation of the dynamic viscosity of water with absolute temperature is given. Using tabular data, a relation is to be obtained for viscosity as a 4<sup>th</sup>-order polynomial. The result is to be compared to Andrade’s equation in the form of  $\mu = D \cdot e^{B/T}$ .

**Properties** The viscosity data are given in tabular form as

T (K)	$\mu$ (Pa·s)
273.15	$1.787 \times 10^{-3}$
278.15	$1.519 \times 10^{-3}$
283.15	$1.307 \times 10^{-3}$
293.15	$1.002 \times 10^{-3}$
303.15	$7.975 \times 10^{-4}$
313.15	$6.529 \times 10^{-4}$
333.15	$4.665 \times 10^{-4}$
353.15	$3.547 \times 10^{-4}$
373.15	$2.828 \times 10^{-4}$

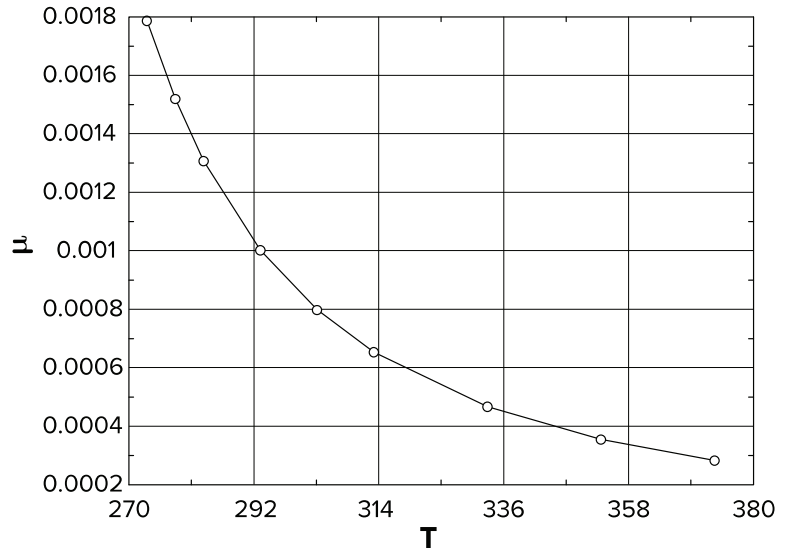

**Analysis** Using EES, (1) Define a trivial function “a=mu+T” in the equation window, (2) select new parametric table from Tables, and type the data in a two-column table, (3) select Plot and plot the data, and (4) select plot and click on “curve fit” to get curve fit window. Then specify polynomial and enter/edit equation. The equations and plot are shown here.

$$\mu = 0.489291758 - 0.00568904387T + 0.0000249152104T^2 - 4.86155745 \times 10^{-8}T^3 + 3.56198079 \times 10^{-11}T^4$$

$$\mu = 0.000001475 \cdot \text{EXP}(1926.5/T) \quad [\text{used initial guess of } a_0=1.8 \times 10^{-6} \text{ and } a_1=1800 \text{ in } \mu=a_0 \cdot \exp(a_1/T)]$$

At  $T = 323.15$  K, the polynomial and exponential curve fits give

*Polynomial:*  $\mu(323.15 \text{ K}) = 0.0005529 \text{ Pa}\cdot\text{s}$  (1.1% error, relative to 0.0005468 Pa·s)  
*Exponential:*  $\mu(323.15 \text{ K}) = 0.0005726 \text{ Pa}\cdot\text{s}$  (4.7% error, relative to 0.0005468 Pa·s)

**Discussion** This problem can also be solved using an Excel worksheet, with the following results:

Polynomial: **A = 0.4893, B = -0.005689, C = 0.00002492, D = -0.000000048612, and E = 0.0000000003562**

Andrade’s equation:  $\mu = 1.807952E-6 * e^{1864.06/T}$

## 2-116

**Solution** A newly produced pipe is tested using pressurized water. The additional water that needs to be pumped to reach a specified pressure is to be determined.

**Assumptions** 1 There is no deformation in the pipe.

**Properties** The coefficient of compressibility is given to be  $2.10 \times 10^9$  Pa.

**Analysis** From Eq. 2-13, we have

$$\kappa \cong \frac{\Delta P}{\frac{\Delta \rho}{\rho}} \rightarrow \frac{\Delta \rho}{\rho} = \frac{\Delta P}{\kappa} \text{ or } \frac{\rho_2 - \rho_1}{\rho_1} = \frac{\Delta P}{\kappa}$$

from which we write

$$\rho_2 = \rho_1 \left( 1 + \frac{\Delta P}{\kappa} \right) = (1000 \text{ kg/m}^3) \times \left( 1 + \frac{10 \times 10^6 \text{ Pa}}{2.10 \times 10^9 \text{ Pa}} \right) = 1004.76 \text{ kg/m}^3$$

Then the amount of additional water is

$$m = V_{\text{cyl}} \Delta \rho = \frac{\pi D^2}{4} L \Delta \rho = \frac{\pi (3 \text{ m})^2}{4} \times (15) \times \left( 1004.76 \frac{\text{kg}}{\text{m}^3} - 1000 \text{ kg/m}^3 \right) = \mathbf{505 \text{ kg}}$$

---

## 2-117

**Solution** We are to prove that the coefficient of volume expansion for an ideal gas is equal to  $1/T$ .

**Assumptions** 1 Temperature and pressure are in the range that the gas can be approximated as an ideal gas.

**Analysis** The ideal gas law is  $P = \rho RT$ , which we re-write as  $\rho = \frac{P}{RT}$ . By definition,  $\beta = -\frac{1}{\rho} \left( \frac{\partial \rho}{\partial T} \right)_P$ . Thus, substitution and differentiation yields

$$\beta_{\text{ideal gas}} = -\frac{1}{\rho} \left( \frac{\partial \left( \frac{P}{RT} \right)}{\partial T} \right)_P = -\frac{1}{\rho} \left( -\frac{P}{RT^2} \right) = \frac{\rho}{\rho} \frac{1}{T} = \mathbf{1/T}$$

where both pressure and the gas constant  $R$  are treated as constants in the differentiation.

**Discussion** The coefficient of volume expansion of an ideal gas is not constant, but rather decreases with temperature. However, for small temperature differences,  $\beta$  is often approximated as a constant with little loss of accuracy.

---

## 2-118

**Solution** The pressure is given at a certain depth of the ocean. An analytical relation between density and pressure is to be obtained and the density at a specified pressure is to be determined. The density is to be compared with that from Eq. 2-13.

**Properties** The coefficient of compressibility is given to be 2350 MPa. The liquid density at the free surface is given to be 1030 kg/m<sup>3</sup>.

**Analysis** (a) From the definition, we have

$$\kappa = \frac{dP}{d\rho/\rho} \rightarrow \frac{d\rho}{\rho} = \frac{dP}{\kappa}$$

Integrating

$$\int_{\rho_0}^{\rho} \frac{d\rho}{\rho} = \int_0^P \frac{dP}{\kappa} \rightarrow \ln \frac{\rho}{\rho_0} = \frac{P}{\kappa} \rightarrow \rho = \rho_0 e^{P/\kappa}$$

With the given data we obtain

$$\rho = (1030 \text{ kg/m}^3) \times e^{100/2350} = 1074 \text{ kg/m}^3$$

(b) Eq. 2-13 can be rearranged to give

$$\Delta\rho \cong \rho \frac{\Delta P}{\kappa}$$

or

$$\rho - \rho_0 \cong \rho_0 \frac{P - P_0}{\kappa} \rightarrow \rho \cong \rho_0 + \rho_0 \frac{P - P_0}{\kappa} = 1030 \frac{\text{kg}}{\text{m}^3} + 1030 \frac{\text{kg}}{\text{m}^3} \times \frac{100 \text{ MPa}}{2350 \text{ MPa}} \approx 1074 \text{ kg/m}^3$$

which is identical with (a). Therefore we conclude that linear approximation (Eq. 2-13) is quite reasonable.

## 2-119E

**Solution** The inlet state and the exit pressure of air are given for an isentropic expansion process. The ratio of the initial to the final speed of sound is to be determined.

**Assumptions** Air is an ideal gas with constant specific heats at room temperature.

**Properties** The properties of air are  $R = 0.06855 \text{ Btu/lbm}\cdot\text{R}$  and  $k = 1.4$ . The specific heat ratio  $k$  varies with temperature, but in our case this change is very small and can be disregarded.

**Analysis** The final temperature of air is determined from the isentropic relation of ideal gases,

$$T_2 = T_1 \left( \frac{P_2}{P_1} \right)^{(k-1)/k} = (240 + 460 \text{ R}) \left( \frac{60}{200} \right)^{(1.4-1)/1.4} = 496.3 \text{ R}$$

Treating  $k$  as a constant, the ratio of the initial to the final speed of sound can be expressed as

$$\text{Ratio} = \frac{c_2}{c_1} = \frac{\sqrt{k_1 R T_1}}{\sqrt{k_2 R T_2}} = \frac{\sqrt{T_1}}{\sqrt{T_2}} = \frac{\sqrt{240 + 460}}{\sqrt{496.3}} = \mathbf{1.19}$$

**Discussion** Note that the speed of sound is proportional to the square root of thermodynamic temperature.

## 2-120

**Solution** A shaft is pulled with a constant velocity through a bearing. The space between the shaft and bearing is filled with a fluid. The force required to maintain the axial movement of the shaft is to be determined.

**Assumptions** 1 The fluid is Newtonian.

**Properties** The viscosity of the fluid is given to be 0.1 Pa·s.

**Analysis**

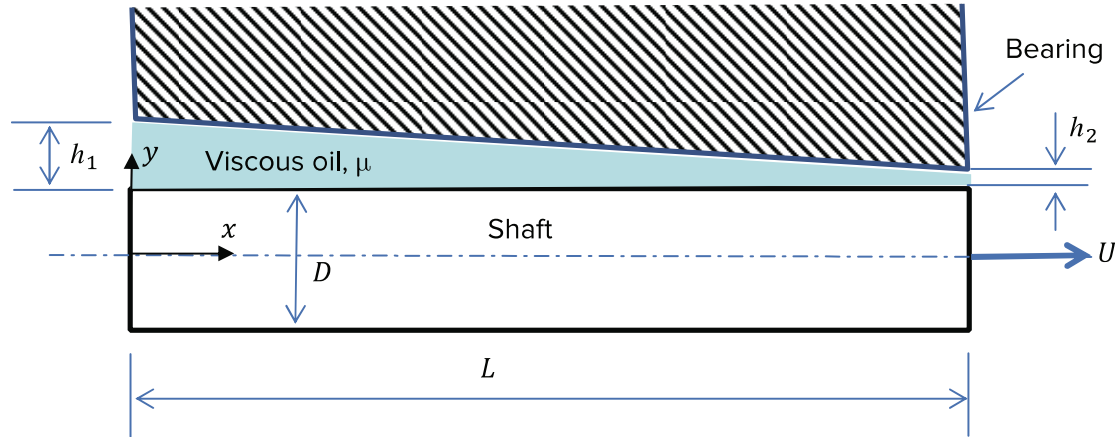

The varying clearance  $h$  can be expressed as a function of axial coordinate  $x$  (see figure). According to this sketch we obtain

$$h = h_1 - (h_1 - h_2) \frac{x}{L}$$

Assuming a linear velocity distribution in the gap, the viscous force acting on the differential strip element is

$$dF = \tau dA = \mu \frac{U}{h} \times \pi D dx = \frac{\mu U \pi D}{h_1 - (h_1 - h_2) \frac{x}{L}} dx$$

Integrating

$$F = \mu U \pi D \int_{x=0}^{x=L} \frac{dx}{h_1 - (h_1 - h_2) \frac{x}{L}} = -\mu U \pi D \left. \frac{\ln \left( h_1 - (h_1 - h_2) \frac{x}{L} \right)}{\frac{(h_1 - h_2)}{L}} \right|_{x=0}^{x=L} = \frac{\mu U \pi D L}{h_1 - h_2} \ln \frac{h_1}{h_2}$$

For the given data, we obtain

$$F = \frac{(0.1 \text{ Pa} \cdot \text{s})(5 \text{ m/s})\pi(80 \times 10^{-3} \text{ mm})(400 \times 10^{-3} \text{ mm})}{(1.2 - 0.4) \times 10^{-3} \text{ mm}} \ln \frac{1.2}{0.4} \cong \mathbf{69 \text{ N}}$$

## 2-121

**Solution** A shaft rotates with a constant angular speed in a bearing. The space between the shaft and bearing is filled with a fluid. The torque required to maintain the motion is to be determined.

**Assumptions** 1 The fluid is Newtonian.

**Properties** The viscosity of the fluid is given to be 0.1 Pa·s.

**Analysis** The varying clearance  $h$  can be expressed as a function of axial coordinate  $x$  (see figure below).

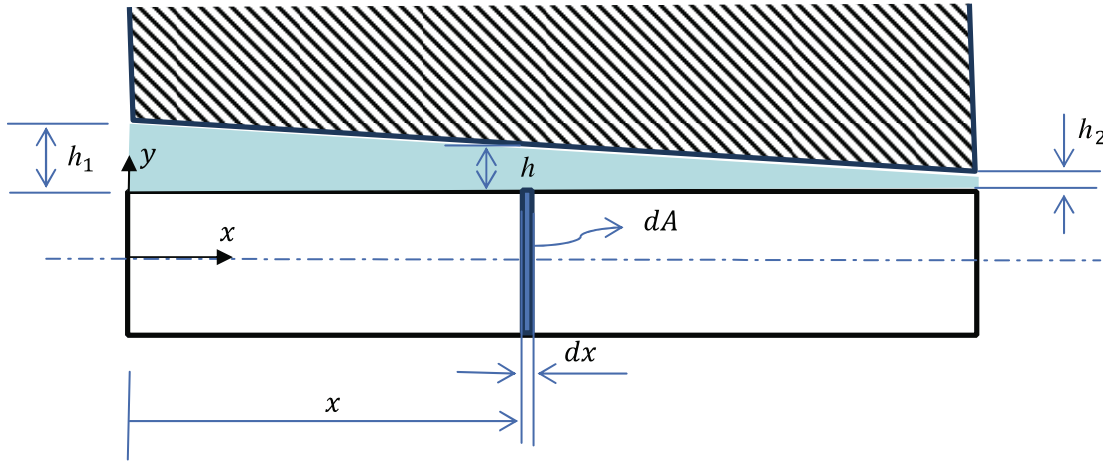

According to this sketch we obtain

$$h = h_1 - (h_1 - h_2) \frac{x}{L}$$

Assuming a linear velocity distribution in the gap, the viscous force acting on the differential strip element is

$$dF = \tau dA = \mu \frac{U}{h} \times \pi D dx = \frac{\mu U \pi D}{h_1 - (h_1 - h_2) \frac{x}{L}} dx$$

where  $U = 2n\pi/60$  in this case. Then the viscous torque developed on the shaft

$$dT = dF \times \frac{D}{2} = \frac{\mu \left( \frac{2n\pi}{60} \times \frac{D}{2} \right) \pi D \times \frac{D}{2}}{h_1 - (h_1 - h_2) \frac{x}{L}} dx = \frac{\mu n \pi^2 D^3}{120} \frac{dx}{h_1 - (h_1 - h_2) \frac{x}{L}}$$

Integrating

$$T = \frac{\mu n \pi^2 D^3}{120} \int_{x=0}^{x=L} \frac{dx}{h_1 - (h_1 - h_2) \frac{x}{L}} = - \frac{\mu n \pi^2 D^3}{120} \frac{\ln \left( h_1 - (h_1 - h_2) \frac{x}{L} \right)}{\frac{(h_1 - h_2)}{L}} \Bigg|_{x=0}^{x=L} = \frac{1}{120} \frac{\mu n \pi^2 D^3 L}{h_1 - h_2} \ln \frac{h_1}{h_2}$$

For the given data, we obtain

$$T = \frac{1}{120} \frac{(0.1 \text{ Pa}\cdot\text{s})(1450 \text{ rpm})\pi^2 (80 \times 10^{-3} \text{ mm})(400 \times 10^{-3} \text{ mm})}{(1.2 - 0.4) \times 10^{-3} \text{ mm}} \ln \frac{1.2}{0.4} \cong 3.35 \text{ N}\cdot\text{m}$$

## 2-122

**Solution** A relation is to be derived for the capillary rise of a liquid between two large parallel plates a distance  $t$  apart inserted into a liquid vertically. The contact angle is given to be  $\phi$ .

**Assumptions** There are no impurities in the liquid, and no contamination on the surfaces of the plates.

**Analysis** The magnitude of the capillary rise between two large parallel plates can be determined from a force balance on the rectangular liquid column of height  $h$  and width  $w$  between the plates. The bottom of the liquid column is at the same level as the free surface of the liquid reservoir, and thus the pressure there must be atmospheric pressure. This will balance the atmospheric pressure acting from the top surface, and thus these two effects will cancel each other. The weight of the liquid column is

$$W = mg = \rho g \mathcal{V} = \rho g(w \times t \times h)$$

Equating the vertical component of the surface tension force to the weight gives

$$W = F_{\text{surface}} \quad \rightarrow \quad \rho g(w \times t \times h) = 2w\sigma_s \cos\phi$$

Canceling  $w$  and solving for  $h$  gives the capillary rise to be

$$\text{Capillary rise:} \quad h = \frac{2\sigma_s \cos\phi}{\rho g t}$$

**Discussion** The relation above is also valid for non-wetting liquids (such as mercury in glass), and gives a capillary drop instead of a capillary rise.

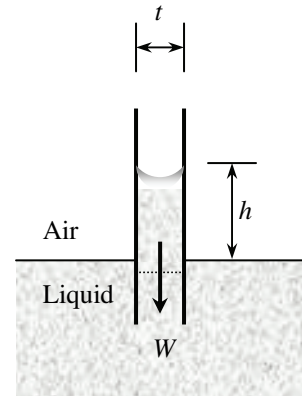

## 2-123

**Solution** A cylindrical shaft rotates inside an oil bearing at a specified speed. The power required to overcome friction is to be determined.

**Assumptions** 1 The gap is uniform, and is completely filled with oil. 2 The end effects on the sides of the bearing are negligible. 3 The fluid is Newtonian.

**Properties** The viscosity of oil is given to be  $0.300 \text{ N}\cdot\text{s}/\text{m}^2$ .

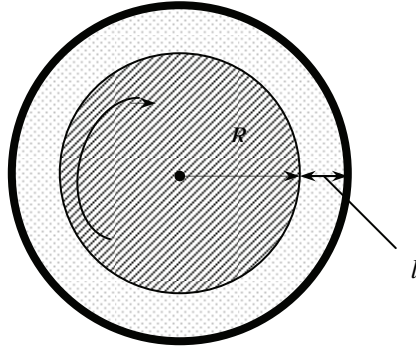

**Analysis** (a) The radius of the shaft is  $R = 0.05 \text{ m}$ , and thickness of the oil layer is  $\ell = (10.3 - 10)/2 = 0.15 \text{ cm}$ . The power-torque relationship is

$$\dot{W} = \omega \mathbf{T} = 2\pi \dot{n} \mathbf{T} \quad \text{where, from Chap. 2, } \mathbf{T} = \mu \frac{4\pi^2 R^3 \dot{n} L}{\ell}$$

Substituting, the required power to overcome friction is determined to be

$$\dot{W} = \mu \frac{6\pi^3 R^3 \dot{n}^2 L}{\ell} = (0.3 \text{ N}\cdot\text{s}/\text{m}^2) \frac{6\pi^3 (0.05 \text{ m})^3 (600/60 \text{ s}^{-1})^2 (0.50 \text{ m})}{0.0015 \text{ m}} \left( \frac{1 \text{ W}}{1 \text{ N}\cdot\text{m}/\text{s}} \right) = \mathbf{233 \text{ W}}$$

(b) For the case of  $\dot{n} = 1200 \text{ rpm}$ :

$$\dot{W} = \mu \frac{6\pi^3 R^3 \dot{n}^2 L}{\ell} = (0.3 \text{ N}\cdot\text{s}/\text{m}^2) \frac{6\pi^3 (0.05 \text{ m})^3 (1200/60 \text{ s}^{-1})^2 (0.50 \text{ m})}{0.0015 \text{ m}} \left( \frac{1 \text{ W}}{1 \text{ N}\cdot\text{m}/\text{s}} \right) = \mathbf{930 \text{ W}}$$

**Discussion** Note the power dissipated in journal bearing is proportional to the cube of the shaft radius and to the square of the shaft speed, and is inversely proportional to the oil layer thickness.



## 2-124

**Solution** A large plate is pulled at a constant speed over a fixed plate. The space between the plates is filled with engine oil. The shear stress developed on the upper plate and its direction are to be determined for parabolic and linear velocity profile cases.

**Assumptions** 1 The thickness of the plate is not important in this problem.

**Properties** The viscosity of oil is  $\mu = 0.8374 \text{ Pa}\cdot\text{s}$  (Table A-7).

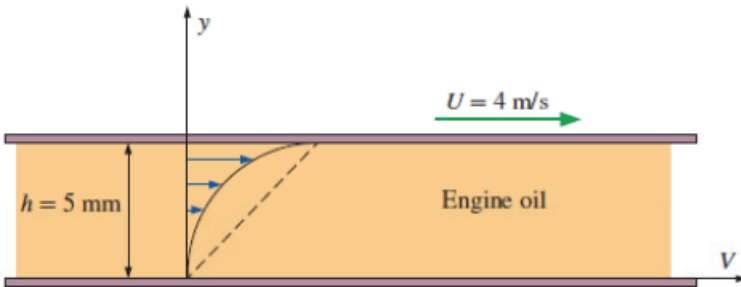
**Analysis**

Considering a parabolic profile we would have  $V^2 = ky$ , where  $k$  is a constant. Since  $V = U = 4 \text{ m/s}$  when  $y = h = 5 \text{ mm} = 5 \times 10^{-3} \text{ m}$ , write

$$\left(4 \frac{\text{m}}{\text{s}}\right)^2 = k \times (5 \times 10^{-3} \text{ m}) \rightarrow k = 3200 \text{ m}^2/\text{s}$$

Then the velocity profile becomes

$$V^2 = 3200y \rightarrow V = 56.568\sqrt{y}$$

Assuming Newtonian behavior, the shear stress on the upper wall is

$$\begin{aligned} \tau &= \mu \frac{dV}{dy} = \mu \frac{d}{dy} (56.568\sqrt{y}) = \mu(56.568) \left( \frac{1}{2\sqrt{y}} \right)_{y=h} \\ &= \mu(56.568) \left( \frac{1}{2\sqrt{h}} \right) = (0.8374 \text{ Pa}\cdot\text{s})(56.568) \left( \frac{1}{2\sqrt{0.005 \text{ m}}} \right) \\ &= \mathbf{325 \text{ N/m}^2} \end{aligned}$$

Since dynamic viscosity of oil is  $0.8374 \text{ Pa}\cdot\text{s}$  (see Table A-7). If we assume a linear profile we will have

$$\frac{dV}{dy} = \frac{U}{h} = \frac{4 \text{ m/s}}{5 \times 10^{-3} \text{ m}} = 800 \text{ s}^{-1}$$

Then the shear stress in this case would be

$$\tau = \mu \frac{dV}{dy} = \mu \frac{U}{h} = (0.8374 \text{ Pa}\cdot\text{s}) \times (800) = \mathbf{670 \text{ N/m}^2}$$

Therefore we conclude that the linear assumption is not realistic since it gives over prediction.

## 2-125

**Solution** Air spaces in certain bricks form air columns of a specified diameter. The height that water can rise in those tubes is to be determined.

**Assumptions** **1** The interconnected air pockets form a cylindrical air column. **2** The air columns are open to the atmospheric air. **3** The contact angle of water is zero,  $\phi = 0$ .

**Properties** The surface tension is given to be 0.085 N/m, and we take the water density to be 1000 kg/m<sup>3</sup>.

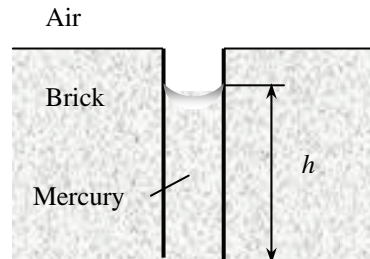

**Analysis** Substituting the numerical values, the capillary rise is determined to be

$$h = \frac{2\sigma_s \cos \phi}{\rho g R} = \frac{2(0.085 \text{ N/m})(\cos 0^\circ)}{(1000 \text{ kg/m}^3)(9.81 \text{ m/s}^2)(3 \times 10^{-6} \text{ m})} \left( \frac{1 \text{ kg} \cdot \text{m/s}^2}{1 \text{ N}} \right) = 5.78 \text{ m}$$

**Discussion** The surface tension depends on temperature. Therefore, the value determined may change with temperature.

---

2-126

**Solution** A fluid between two long parallel plates is heated as the upper plate is moving. A relation for the fluid velocity is to be obtained and velocity profile is to be plotted. Also the shear stress is to be calculated and its direction is to be shown.

**Assumptions** 1 Flow is parallel to plates. 2 Flow is one-dimensional. 3 Pressure is constant. 4 Fluid is Newtonian and incompressible. 5 Gravitational effect is neglected.

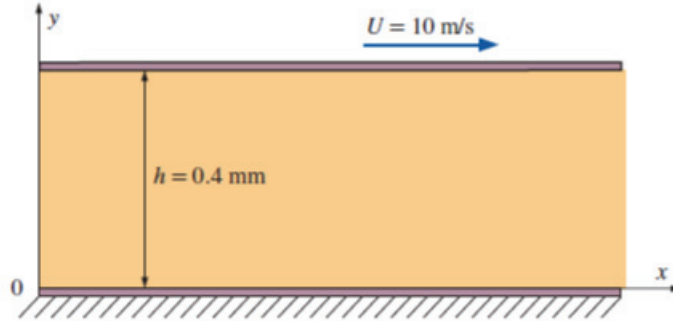

**Analysis** (a) Taking an infinitesimal fluid element and applying force balance (assuming one dimensional flow),

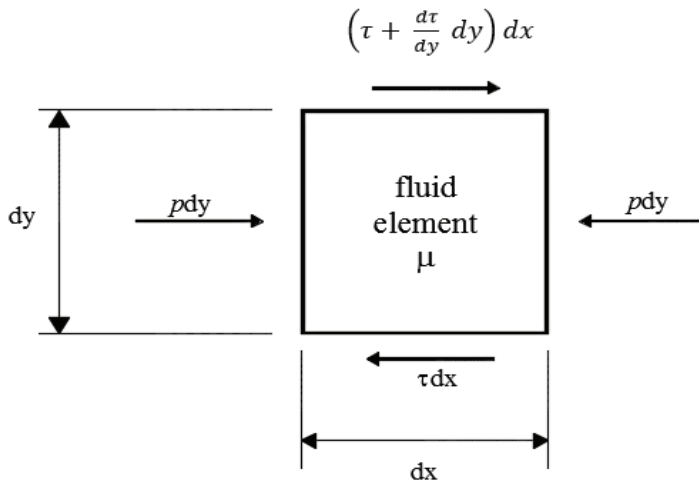

The force equilibrium in  $x$  direction yields

$$\frac{d\tau}{dy} = 0 \rightarrow \tau = \text{constant} \quad (1)$$

Then, Newton's law of viscosity yields

$$\tau = \mu \frac{du}{dy} = \text{constant} \quad (2)$$

The viscosity is changing linearly with respect to  $y$ . Thus, it can be expressed in the form  $\mu = Ay + B$  where  $A, B$  are constants.

Using (i) at  $y = 0, \mu = 0.90 \text{ Pa}\cdot\text{s}$  and, (ii) at  $y = 0.0004 \text{ m}, \mu = 0.50 \text{ Pa}\cdot\text{s}$ ,  $A, B$  can be determined and the viscosity function is found  $\mu = 0.90 - 1000y$

Substituting the viscosity function in equation (3) yields

$$\tau = \mu \frac{du}{dy} = (0.9 - 1000y) \frac{du}{dy} = \text{constant} = C \rightarrow \frac{du}{dy} = \frac{C}{0.9 - 1000y} \quad (3)$$

$$u = C \int \frac{dy}{0.9 - 1000y} + D$$

$$= E \ln(0.9 - 1000y) + D \quad (4)$$

where  $E, D$  are integration constants to be determined. Using the no-slip boundary conditions: (i) at  $y = 0, u = 0$  and, (ii) at  $y = 0.0004 \text{ m}, u = 10 \text{ m/s}$ ,  $E, D$  can be determined and the velocity function is found as

$$u(y) = \frac{10}{\ln \frac{9}{5}} \left( \frac{0.9}{0.9 - 1000y} \right) \quad (5)$$

The velocity function is plotted below. The velocity vectors are also shown. For comparison, a linear profile is also plotted. As seen below, the rate at which velocity increases towards the moving plate is not constant – this rate increases as one approaches the moving plate side. This is expected. The viscosity decreases towards the moving plate. To keep the shear stress constant (as was founded earlier), the velocity should increase more and more (not a constant rate) as one approaches the moving plate.

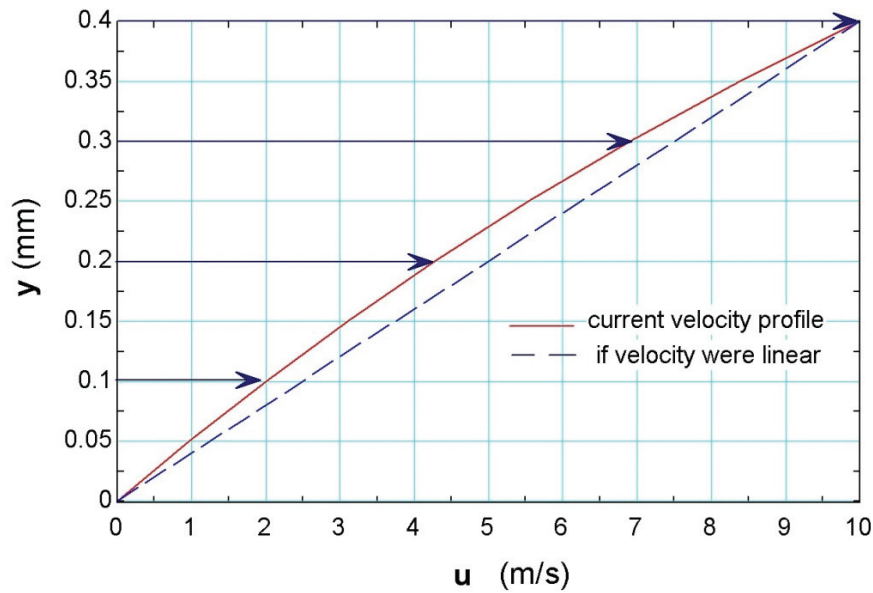

(b) Using Newton's law of viscosity

$$\tau = \mu \frac{du}{dy} = (0.9 - 1000y) \frac{10}{\ln \frac{9}{5}} \frac{(1000)(0.9)}{(0.9 - 1000y)^2} \frac{0.9 - 1000y}{0.9} = \mathbf{17,000 \text{ Pa}} \quad (6)$$

As found earlier, the shear stress is constant throughout the flow.

The shear stress directions on the top surface of the fluid element adjacent to the moving plate, and on the moving plate are:

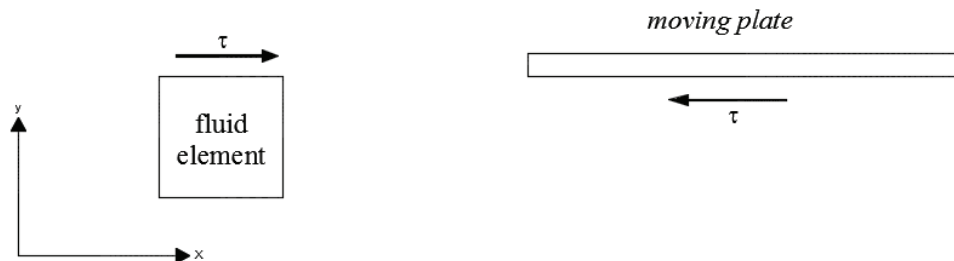

2-127

**Solution** A thrust bearing is operated with a thin film of oil. The ratio of lost power in the thrust bearing to the produced power is to be determined.

**Assumptions** 1 Fluid is Newtonian and incompressible. 2 Linear velocity assumption is correct in the bearing. 3 Gravitational effect is neglected.

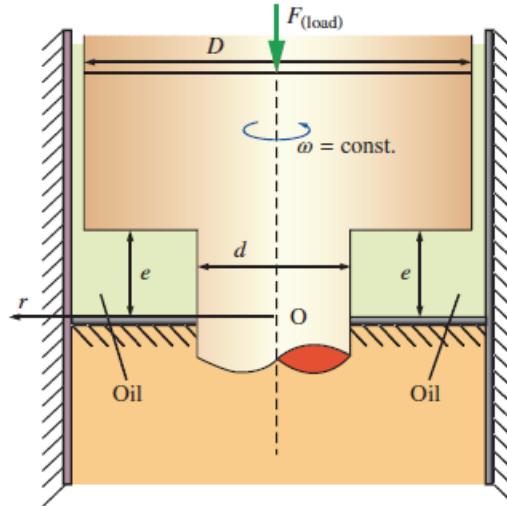

**Analysis** Due to the linear velocity assumption is correct in the bearing, shear stress on the position  $r = r$ ;

$$\tau = \mu \frac{du}{dr} = \mu \frac{\Delta u}{\Delta r} = \mu \frac{U - 0}{e} = \mu \frac{U}{e} = \mu \frac{\omega r}{e} \quad (1)$$

Angular velocity,  $\omega = 2\pi n/60$

$$\tau = \frac{2\mu\pi nr}{60e} = \frac{\mu\pi nr}{30e} \quad (2)$$

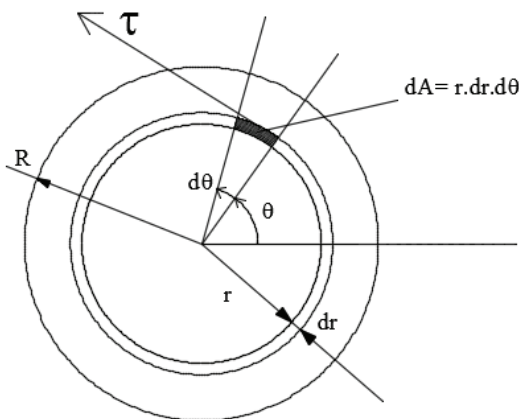

Friction force on the rotating differential surface,  $dA = r \cdot d\theta \cdot dr$ ,

$$dF_S = \tau \cdot dA = \tau \cdot r \cdot d\theta \cdot dr \quad (3)$$

Torque on the rotating axis of this force,

$$dT_S = r \cdot dF_S \quad (4)$$

Integrating equation (4),

Total Torque,

$$T_S = \frac{\mu\pi n}{30e} \int_0^{2\pi} d\theta \int_{r_1}^{r_2} r^3 dr = \frac{2\mu\pi^2 n}{30e} \frac{(r_2^4 - r_1^4)}{4} = \frac{\mu\pi^2 n}{60e} (r_2^4 - r_1^4) \quad (5)$$

Total Friction Power (loss power),

$$P_S = \omega \cdot T_S = \frac{2\pi n}{60} \frac{\mu\pi^2 n}{60e} (r_2^4 - r_1^4) = \frac{\mu\pi^3 n^2}{1800e} (r_2^4 - r_1^4) = \frac{(0.038)\pi^3 (550)^2 [1.6^4 - 1.2^4]}{(1800)(0.22)10^{-3}} \quad (6)$$

$$P_S = 4032194 \text{ W} = 4.032194 \text{ MW}$$

$$\frac{P_S}{P} = \frac{4.032194}{50} = 0.08064 \cong \mathbf{8.06\%}$$

## 2-128

**Solution** A multi-disk Electro-rheological “ER” clutch is considered. The ER fluid has a shear stress that is expressed as  $\tau = \tau_y + \mu(du/dy)$ . A relationship for the torque transmitted by the clutch is to be obtained, and the numerical value of the torque is to be calculated.

**Assumptions** 1 The thickness of the oil layer between the disks is constant. 2 The Bingham plastic model for shear stress expressed as  $\tau = \tau_y + \mu(du/dy)$  is valid.

**Properties** The constants in shear stress relation are given to be  $\mu = 0.1 \text{ Pa}\cdot\text{s}$  and  $\tau_y = 2.5 \text{ kPa}$ .

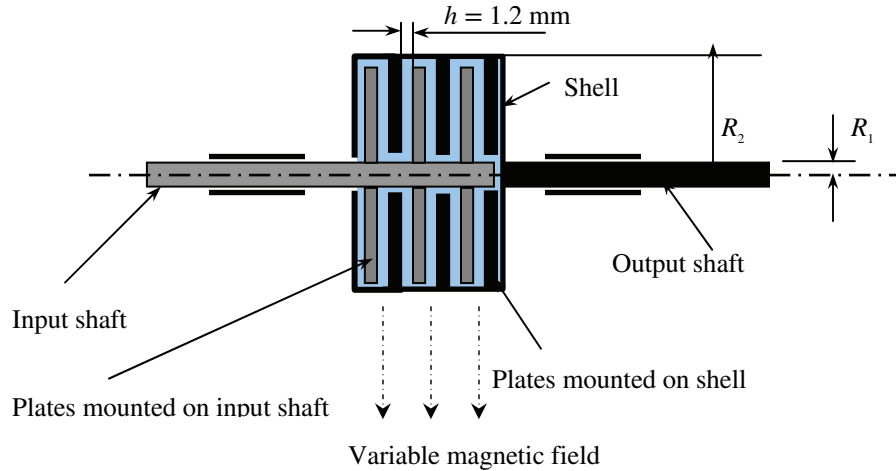

**Analysis** (a) The velocity gradient anywhere in the oil of film thickness  $h$  is  $V/h$  where  $V = \omega r$  is the tangential velocity relative to plates mounted on the shell. Then the wall shear stress anywhere on the surface of a plate mounted on the input shaft at a distance  $r$  from the axis of rotation is expressed as

$$\tau_w = \tau_y + \mu \frac{du}{dr} = \tau_y + \mu \frac{V}{h} = \tau_y + \mu \frac{\omega r}{h}$$

Then the shear force acting on a differential area  $dA$  on the surface of a disk and the torque generation associated with it are expressed as

$$dF = \tau_w dA = \left( \tau_y + \mu \frac{\omega r}{h} \right) (2\pi r) dr$$

$$dT = r dF = r \left( \tau_y + \mu \frac{\omega r}{h} \right) (2\pi r) dr = 2\pi \left( \tau_y r^2 + \mu \frac{\omega r^3}{h} \right) dr$$

Integrating,

$$T = 2\pi \int_{r=R_1}^{R_2} \left( \tau_y r^2 + \mu \frac{\omega r^3}{h} \right) dr = 2\pi \left[ \tau_y \frac{r^3}{3} + \frac{\mu \omega r^4}{4h} \right]_{r=R_1}^{R_2} = 2\pi \left[ \frac{\tau_y}{3} (R_2^3 - R_1^3) + \frac{\mu \omega}{4h} (R_2^4 - R_1^4) \right]$$

This is the torque transmitted by one surface of a plate mounted on the input shaft. Then the torque transmitted by both surfaces of  $N$  plates attached to input shaft in the clutch becomes

$$T = 4\pi N \left[ \frac{\tau_y}{3} (R_2^3 - R_1^3) + \frac{\mu \omega}{4h} (R_2^4 - R_1^4) \right]$$

(b) Noting that  $\omega = 2\pi \dot{n} = 2\pi(2400 \text{ rev/min}) = 15,080 \text{ rad/min} = 251.3 \text{ rad/s}$  and substituting,

$$T = (4\pi)(11) \left[ \frac{2500 \text{ N/m}^2}{3} [(0.20 \text{ m})^3 - (0.05 \text{ m})^3] + \frac{(0.1 \text{ N}\cdot\text{s/m}^2)(251.3 \text{ /s})}{4(0.0012 \text{ m})} [(0.20 \text{ m})^4 - (0.05 \text{ m})^4] \right] = \mathbf{2060 \text{ N}\cdot\text{m}}$$

**Discussion** Can you think of some other potential applications for this kind of fluid?

## 2-129

**Solution** A multi-disk magnetorheological “MR” clutch is considered. The MR fluid has a shear stress that is expressed as  $\tau = \tau_y + K(du/dy)^m$ . A relationship for the torque transmitted by the clutch is to be obtained, and the numerical value of the torque is to be calculated.

**Assumptions** 1 The thickness of the oil layer between the disks is constant. 2 The Herschel-Bulkley model for shear stress expressed as  $\tau = \tau_y + K(du/dy)^m$  is valid.

**Properties** The constants in shear stress relation are given to be  $\tau_y = 900$  Pa,  $K = 58$  Pa·s<sup>m</sup>, and  $m = 0.82$ .

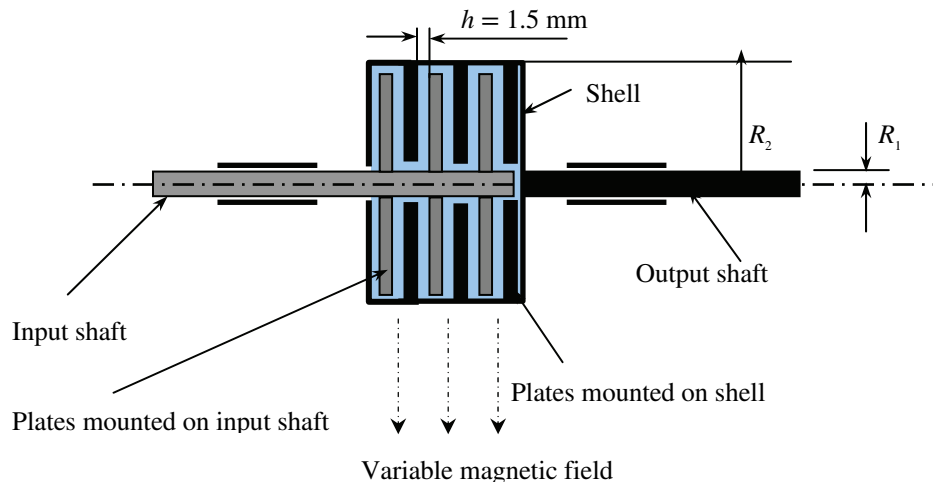

**Analysis** (a) The velocity gradient anywhere in the oil of film thickness  $h$  is  $V/h$  where  $V = \omega r$  is the tangential velocity relative to plates mounted on the shell. Then the wall shear stress anywhere on the surface of a plate mounted on the input shaft at a distance  $r$  from the axis of rotation is expressed as

$$\tau_w = \tau_y + K \left( \frac{du}{dr} \right)^m = \tau_y + K \left( \frac{V}{h} \right)^m = \tau_y + K \left( \frac{\omega r}{h} \right)^m$$

Then the shear force acting on a differential area  $dA$  on the surface of a disk and the torque generation associated with it are expressed as

$$dF = \tau_w dA = \left( \tau_y + K \left( \frac{\omega r}{h} \right)^m \right) (2\pi r) dr \quad \text{and} \quad dT = r dF = r \left( \tau_y + K \left( \frac{\omega r}{h} \right)^m \right) (2\pi r) dr = 2\pi \left( \tau_y r^2 + K \frac{\omega^m r^{m+2}}{h^m} \right) dr$$

Integrating,

$$T = 2\pi \int_{R_1}^{R_2} \left( \tau_y r^2 + K \frac{\omega^m r^{m+2}}{h^m} \right) dr = 2\pi \left[ \tau_y \frac{r^3}{3} + \frac{K \omega^m r^{m+3}}{(m+3)h^m} \right]_{R_1}^{R_2} = 2\pi \left[ \frac{\tau_y}{3} (R_2^3 - R_1^3) + \frac{K \omega^m}{(m+3)h^m} (R_2^{m+3} - R_1^{m+3}) \right]$$

This is the torque transmitted by one surface of a plate mounted on the input shaft. Then the torque transmitted by both surfaces of  $N$  plates attached to input shaft in the clutch becomes

$$T = 4\pi N \left[ \frac{\tau_y}{3} (R_2^3 - R_1^3) + \frac{K \omega^m}{(m+3)h^m} (R_2^{m+3} - R_1^{m+3}) \right]$$

(b) Noting that  $\omega = 2\pi n = 2\pi(3000 \text{ rev/min}) = 18,850 \text{ rad/min} = 314.2 \text{ rad/s}$  and substituting,

$$T = (4\pi)(11) \left[ \frac{900 \text{ N/m}^2}{3} [(0.20 \text{ m})^3 - (0.05 \text{ m})^3] + \frac{(58 \text{ N} \cdot \text{s}^{0.82}/\text{m}^2)(314.2 \text{ /s})^{0.82}}{(0.82 + 3)(0.0015 \text{ m})^{0.82}} [(0.20 \text{ m})^{3.82} - (0.05 \text{ m})^{3.82}] \right] \\ = 103.4 \text{ kN} \cdot \text{m}$$

**Discussion** Can you think of some other potential applications for this kind of fluid?



## 2-130

**Solution** The laminar flow of a Bingham plastic fluid in a horizontal pipe of radius  $R$  is considered. The shear stress at the pipe wall and the friction drag force acting on a pipe section of length  $L$  are to be determined.

**Assumptions** 1 The fluid is a Bingham plastic with  $\tau = \tau_y + \mu(du/dr)$  where  $\tau_y$  is the yield stress. 2 The flow through the pipe is one-dimensional.

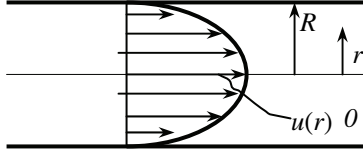

**Analysis** The velocity profile is given by  $u(r) = \frac{\Delta P}{4\mu L}(r^2 - R^2) + \frac{\tau_y}{\mu}(r - R)$  where  $\Delta P/L$  is the pressure drop along the pipe per unit length,  $\mu$  is the dynamic viscosity,  $r$  is the radial distance from the centerline. Its gradient at the pipe wall ( $r = R$ ) is

$$\left. \frac{du}{dr} \right|_{r=R} = \left. \frac{d}{dr} \left( \frac{\Delta P}{4\mu L}(r^2 - R^2) + \frac{\tau_y}{\mu}(r - R) \right) \right|_{r=R} = \left( 2r \frac{\Delta P}{4\mu L} + \frac{\tau_y}{\mu} \right)_{r=R} = \frac{1}{\mu} \left( \frac{\Delta P}{2L} R + \tau_y \right)$$

Substituting into  $\tau = \tau_y + \mu(du/dr)$ , the wall shear stress at the pipe surface becomes

$$\tau_w = \tau_y + \mu \left. \frac{du}{dr} \right|_{r=R} = \tau_y + \frac{\Delta P}{2L} R + \tau_y = 2\tau_y + \frac{\Delta P}{2L} R$$

Then the friction drag force exerted by the fluid on the inner surface of the pipe becomes

$$F_D = \tau_w A_s = \left( 2\tau_y + \frac{\Delta P}{2L} R \right) (2\pi RL) = 2\pi RL \left( 2\tau_y + \frac{\Delta P}{2L} R \right) = 4\pi RL\tau_y + \pi R^2 \Delta P$$

**Discussion** Note that the total friction drag is proportional to yield shear stress and the pressure drop.

## 2-131

**Solution** A circular disk immersed in oil is used as a damper, as shown in the figure. It is to be shown that the damping torque is  $T_{\text{damping}} = C\omega$  where  $C = 0.5\pi\mu\left(\frac{1}{a} + \frac{1}{b}\right)R^4$ .

**Assumptions** 1 The thickness of the oil layer on each side remains constant. 2 The velocity profiles are linear on both sides of the disk. 3 The tip effects are negligible. 4 The effect of the shaft is negligible.

**Analysis** The velocity gradient anywhere in the oil of film thickness  $a$  is  $V/a$  where  $V = \omega r$  is the tangential velocity. Then the wall shear stress anywhere on the upper surface of the disk at a distance  $r$  from the axis of rotation can be expressed as

$$\tau_w = \mu \frac{du}{dy} = \mu \frac{V}{a} = \mu \frac{\omega r}{a}$$

Then the shear force acting on a differential area  $dA$  on the surface and the torque it generates can be expressed as

$$dF = \tau_w dA = \mu \frac{\omega r}{a} dA$$

$$dT = r dF = \mu \frac{\omega r^2}{a} dA$$

Noting that  $dA = 2\pi r dr$  and integrating, the torque on the top surface is determined to be

$$T_{\text{top}} = \frac{\mu\omega}{a} \int_A r^2 dA = \frac{\mu\omega}{a} \int_{r=0}^R r^2 (2\pi r) dr = \frac{2\pi\mu\omega}{a} \int_{r=0}^R r^3 dr = \frac{2\pi\mu\omega}{a} \frac{r^4}{4} \Big|_{r=0}^R = \frac{\pi\mu\omega R^4}{2a}$$

The torque on the bottom surface is obtained by replaying  $a$  by  $b$ ,

$$T_{\text{bottom}} = \frac{\pi\mu\omega R^4}{2b}$$

The total torque acting on the disk is the sum of the torques acting on the top and bottom surfaces,

$$T_{\text{damping, total}} = T_{\text{bottom}} + T_{\text{top}} = \frac{\pi\mu\omega R^4}{2} \left( \frac{1}{a} + \frac{1}{b} \right)$$

or,

$$T_{\text{damping, total}} = C\omega \quad \text{where} \quad C = \frac{\pi\mu R^4}{2} \left( \frac{1}{a} + \frac{1}{b} \right)$$

This completes the proof.

**Discussion** Note that the damping torque (and thus damping power) is inversely proportional to the thickness of oil films on either side, and it is proportional to the 4<sup>th</sup> power of the radius of the damper disk.

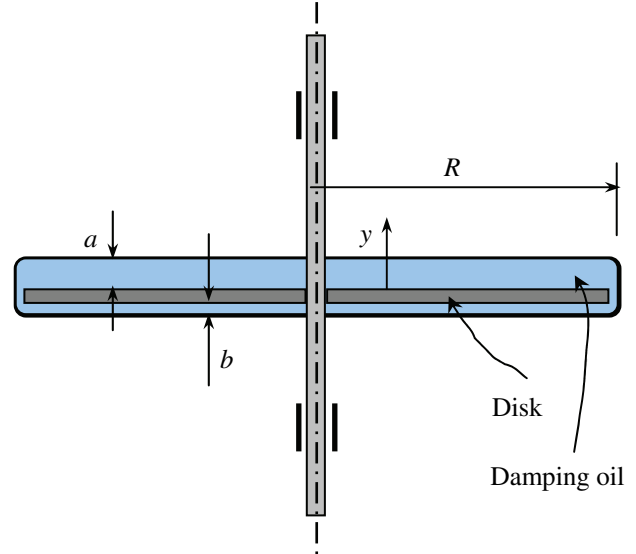

## 2-132

**Solution** A thin oil film is sandwiched between two large parallel plates with top plate stationary and bottom plate moving. A third plate is dragged through the oil. The velocity profile is to be sketched and the vertical distance where the velocity is zero is to be determined. Also, the force required to keep the middle plate at constant speed is to be determined.

**Assumptions** 1 Flow is parallel to plates. 2 Flow is one-dimensional. 3 Pressure is constant. 4 Fluid is Newtonian and incompressible. 5 Gravitational effect is neglected.

**Analysis** (a) The velocity profiles are expected to be linear with respect to  $y$ , and independent of  $x$ . At some  $x$  location, we sketch the velocity profile in both the upper and lower fluid regions, keeping in mind the no-slip boundary conditions:  $u = 0$  at the top wall,  $u = 1$  m/s at the plate (both sides), and  $u = -0.3$  m/s at the bottom wall.

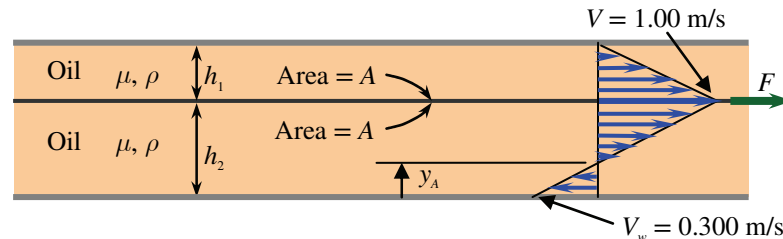

Equating triangles, we know that  $u = 0$  at  $y = y_A$ , where  $y_A/V_w = h_2/(V_{\text{plate}} + V_w)$  or  $y_A = V_w h_2/(V_{\text{plate}} + V_w)$ . Plugging in the numerical values, we get  $y_A = (0.300 \text{ m/s})(1.65 \text{ mm})/(1.00 + 0.300) \text{ m/s} = 0.381 \text{ mm}$ .

$$y_A = 0.381 \text{ mm}$$

(b) To calculate the force needed to pull the plate, we draw a free body diagram of the plate,



For constant plate speed (no acceleration),  $F = F_1 + F_2$ . But we can calculate these two forces independently based on the shear stress at the walls of the plate,

$$F_1 = \tau_1 A = \mu \left. \frac{du}{dy} \right|_1 A \quad \text{and} \quad F_2 = \tau_2 A = \mu \left. \frac{du}{dy} \right|_2 A. \quad \text{Thus, } F = F_1 + F_2 = \mu A \left( \left. \frac{du}{dy} \right|_1 + \left. \frac{du}{dy} \right|_2 \right).$$

Plugging in the numbers, we get

$$F = (0.0357 \text{ N}\cdot\text{s/m}^2)(0.20 \times 0.20 \text{ m}^2) \left[ \frac{(1-0) \text{ m/s}}{0.001 \text{ m}} + \frac{(1-(-0.30)) \text{ m/s}}{0.00165 \text{ m}} \right] = 2.55 \text{ N}$$

$$F = 2.55 \text{ N}$$

**Discussion** There are forces acting on the bottom and top walls also. You should be able to calculate these yourself.

---

**Fundamentals of Engineering (FE) Exam Problems**

---

**2-133**

The specific gravity of a fluid is specified to be 0.82. The specific volume of this fluid is

- (a)  $0.001 \text{ m}^3/\text{kg}$       (b)  $0.00122 \text{ m}^3/\text{kg}$       (c)  $0.0082 \text{ m}^3/\text{kg}$       (d)  $82 \text{ m}^3/\text{kg}$   
(e)  $820 \text{ m}^3/\text{kg}$

*Answer* (b)  $0.00122 \text{ m}^3/\text{kg}$

**Solution** Solved by EES Software. Solutions can be verified by copying-and-pasting the following lines on a blank EES screen. (Similar problems and their solutions can be obtained easily by modifying numerical values).

```
SG=0.82
rho_water=1000 [kg/m^3]
rho_fluid=SG*rho_water
v=1/rho_fluid
```

**2-134**

The specific gravity of mercury is 13.6. The specific weight of mercury is

- (a)  $1.36 \text{ kN/m}^3$     (b)  $9.81 \text{ kN/m}^3$     (c)  $106 \text{ kN/m}^3$     (d)  $133 \text{ kN/m}^3$     (e)  $13,600 \text{ kN/m}^3$

*Answer* (d)  $133 \text{ kN/m}^3$

**Solution** Solved by EES Software. Solutions can be verified by copying-and-pasting the following lines on a blank EES screen. (Similar problems and their solutions can be obtained easily by modifying numerical values).

```
SG=13.6
rho_water=1000 [kg/m^3]
rho=SG*rho_water
g=9.81 [m/s^2]
SW=rho*g
```

## 2-135

A 0.08-m<sup>3</sup> rigid tank contains air at 3 bar and 127°C. The mass of the air in the tank is

- (a) 0.209 kg    (b) 0.659 kg    (c) 0.8 kg    (d) 0.002 kg    (e) 0.066 kg

Answer (a) 0.209 kg

**Solution** Solved by EES Software. Solutions can be verified by copying-and-pasting the following lines on a blank EES screen. (Similar problems and their solutions can be obtained easily by modifying numerical values).

```
V=0.08 [m^3]
P=300 [kPa]
T=(127+273) [K]
R=0.287 [kJ/kg-K]
m=(P*V)/(R*T)
```

## 2-136

The pressure of water is increased from 100 kPa to 700 kPa by a pump. The density of water is 1 kg/L. If the water temperature does not change during this process, the enthalpy change of the water is

- (a) 400 kJ/kg    (b) 0.4 kJ/kg    (c) 600 kJ/kg    (d) 800 kJ/kg    (e) 0.6 kJ/kg

Answer (e) 0.6 kJ/kg

**Solution** Solved by EES Software. Solutions can be verified by copying-and-pasting the following lines on a blank EES screen. (Similar problems and their solutions can be obtained easily by modifying numerical values).

```
P1=100 [kPa]
P2=700 [kPa]
rho=1000 [kg/m^3]
DELTAh=(P2-P1)/rho
```

## 2-137

An ideal gas flows in a pipe at 37°C. The density of the gas is 1.9 kg/m<sup>3</sup> and its molar mass is 44 kg/kmol. The pressure of the gas is

- (a) 13 kPa    (b) 79 kPa    (c) 111 kPa    (d) 490 kPa    (e) 4900 kPa

Answer (c) 111 kPa

**Solution** Solved by EES Software. Solutions can be verified by copying-and-pasting the following lines on a blank EES screen. (Similar problems and their solutions can be obtained easily by modifying numerical values).

```
T=(37+273) [K]
rho=1.9 [kg/m^3]
MM=44 [kg/kmol]
R_u=8.314 [kJ/kmol-K]
R=R_u/MM
P=rho*R*T
```

## 2-138

Liquid water vaporizes into water vapor as it flows in the piping of a boiler. If the temperature of water in the pipe is 180°C, the vapor pressure of water in the pipe is

- (a) 1002 kPa    (b) 180 kPa    (c) 101.3 kPa    (d) 18 kPa    (e) 100 kPa

Answer (a) 1002 kPa

**Solution** Solved by EES Software. Solutions can be verified by copying-and-pasting the following lines on a blank EES screen. (Similar problems and their solutions can be obtained easily by modifying numerical values).

```
T=180 [C]
P_vapor=pressure(steam, T=T, x=1)
```

## 2-139

In a water distribution system, the pressure of water can be as low as 1.4 psia. The maximum temperature of water allowed in the piping to avoid cavitation is

- (a) 50°F    (b) 77°F    (c) 100°F    (d) 113°F    (e) 140°F

Answer (d) 113°F

**Solution** Solved by EES Software. Solutions can be verified by copying-and-pasting the following lines on a blank EES screen. (Similar problems and their solutions can be obtained easily by modifying numerical values).

```
P=1.4 [psia]
T_max=temperature(steam, P=P, x=1)
```

## 2-140

The pressure of water is increased from 100 kPa to 900 kPa by a pump. The temperature of water also increases by 0.15°C. The density of water is 1 kg/L and its specific heat is  $c_p = 4.18$  kJ/kg·°C. The enthalpy change of the water during this process is

- (a) 900 kJ/kg    (b) 1.43 kJ/kg    (c) 4.18 kJ/kg    (d) 0.63 kJ/kg    (e) 0.80 kJ/kg

Answer (b) 1.43 kJ/kg

**Solution** Solved by EES Software. Solutions can be verified by copying-and-pasting the following lines on a blank EES screen. (Similar problems and their solutions can be obtained easily by modifying numerical values).

```
P1=100 [kPa]
P2=900 [kPa]
DELTA T=0.15 [C]
rho=1000 [kg/m^3]
c_p=4.18 [kJ/kg-C]
DELTA h=c_p*DELTA T+(P2-P1)/rho
```

## 2-141

An ideal gas is compressed isothermally from 100 kPa to 170 kPa. The percent increase in the density of this gas during this process is

- (a) 70%      (b) 35%      (c) 17%      (d) 59%      (e) 170%

Answer (a) 70%

**Solution** Solved by EES Software. Solutions can be verified by copying-and-pasting the following lines on a blank EES screen. (Similar problems and their solutions can be obtained easily by modifying numerical values).

```
P1=100 [kPa]
P2=170 [kPa]
DELTAP=P2-P1
DELTAP/P=DELTAP/P1*Convert(,%)
DELTArho\rho=DELTAP/P
```

## 2-142

The variation of the density of a fluid with temperature at constant pressure is represented by

- (a) Bulk modulus of elasticity      (b) Coefficient of compressibility  
 (c) Isothermal compressibility      (d) Coefficient of volume expansion  
 (e) None of these

Answer (d) Coefficient of volume expansion

## 2-143

Water is heated from 2°C to 78°C at a constant pressure of 100 kPa. The initial density of water is 1000 kg/m<sup>3</sup> and the volume expansion coefficient of water is  $\beta = 0.377 \times 10^{-3} \text{ K}^{-1}$ . The final density of the water is

- (a) 28.7 kg/m<sup>3</sup>      (b) 539 kg/m<sup>3</sup>      (c) 997 kg/m<sup>3</sup>      (d) 984 kg/m<sup>3</sup>      (e) 971 kg/m<sup>3</sup>

Answer (e) 971 kg/m<sup>3</sup>

**Solution** Solved by EES Software. Solutions can be verified by copying-and-pasting the following lines on a blank EES screen. (Similar problems and their solutions can be obtained easily by modifying numerical values).

```
T1=2 [C]
T2=78 [C]
P=100 [kPa]
rho_1=1000 [kg/m^3]
beta=0.377E-3 [1/K]
DELTAT=T2-T1
DELTArho=-beta*rho_1*DELTAT
DELTArho=rho_2-rho_1
```

## 2-144

The viscosity of liquids \_\_\_\_\_ and the viscosity of gases \_\_\_\_\_ with temperature.

- (a) Increases, increases      (b) Increases, decreases      (c) Decreases, increases  
 (d) Decreases, decreases      (e) Decreases, remains the same

*Answer* (c) Decreases, increases

## 2-145

The pressure of water at atmospheric pressure must be raised to 210 atm to compress it by 1 percent. Then, the coefficient of compressibility value of water is

- (a) 209 atm      (b) 20,900 atm      (c) 21 atm      (d) 0.21 atm      (e) 210,000 atm

*Answer* (b) 20,900 atm

**Solution** Solved by EES Software. Solutions can be verified by copying-and-pasting the following lines on a blank EES screen. (Similar problems and their solutions can be obtained easily by modifying numerical values).

```
P1=1 [atm]
P2=210 [atm]
DELTArho\rho=0.01
DELTAP=P2-P1
CoeffComp=DELTAP/DELTArho\rho
```

## 2-146

The density of a fluid decreases by 3 percent at constant pressure when its temperature increases by 10°C. The coefficient of volume expansion of this fluid is

- (a) 0.03 K<sup>-1</sup>      (b) 0.003 K<sup>-1</sup>      (c) 0.1 K<sup>-1</sup>      (d) 0.5 K<sup>-1</sup>      (e) 3 K<sup>-1</sup>

*Answer* (b) 0.003 K<sup>-1</sup>

**Solution** Solved by EES Software. Solutions can be verified by copying-and-pasting the following lines on a blank EES screen. (Similar problems and their solutions can be obtained easily by modifying numerical values).

```
DELTArho\rho=-0.03
DELTAT=10 [K]
beta=-DELTArho\rho/DELTAT
```



## 2-147

The speed of a spacecraft is given to be 1250 km/h in atmospheric air at  $-40^{\circ}\text{C}$ . The Mach number of this flow is

- (a) 35.9      (b) 0.85      (c) 1.0      (d) 1.13      (e) 2.74

Answer (d) 1.13

**Solution** Solved by EES Software. Solutions can be verified by copying-and-pasting the following lines on a blank EES screen. (Similar problems and their solutions can be obtained easily by modifying numerical values).

```
Vel=1250 [km/h]*Convert(km/h, m/s)
T=(-40+273.15) [K]
R=0.287 [kJ/kg-K]
k=1.4
c=sqrt(k*R*T*Convert(kJ/kg, m^2/s^2))
Ma=Vel/c
```

## 2-148

The dynamic viscosity of air at  $20^{\circ}\text{C}$  and 200 kPa is  $1.83 \times 10^{-5}$  kg/m·s. The kinematic viscosity of air at this state is

- (a)  $0.525 \times 10^{-5}$  m<sup>2</sup>/s      (b)  $0.77 \times 10^{-5}$  m<sup>2</sup>/s      (c)  $1.47 \times 10^{-5}$  m<sup>2</sup>/s      (d)  $1.83 \times 10^{-5}$  m<sup>2</sup>/s  
(e)  $0.380 \times 10^{-5}$  m<sup>2</sup>/s

Answer (b)  $0.77 \times 10^{-5}$  m<sup>2</sup>/s

**Solution** Solved by EES Software. Solutions can be verified by copying-and-pasting the following lines on a blank EES screen. (Similar problems and their solutions can be obtained easily by modifying numerical values).

```
T=(20+273.15) [K]
P=200 [kPa]
mu=1.83E-5 [kg/m-s]
R=0.287 [kJ/kg-K]
rho=P/(R*T)
nu=mu/rho
```

## 2-149

A viscometer constructed of two 30-cm-long concentric cylinders is used to measure the viscosity of a fluid. The outer diameter of the inner cylinder is 9 cm, and the gap between the two cylinders is 0.18 cm.

The inner cylinder is rotated at 250 rpm, and the torque is measured to be 1.4 N·m. The viscosity of the fluid is

- (a)  $0.0084 \text{ N}\cdot\text{s}/\text{m}^2$     (b)  $0.017 \text{ N}\cdot\text{s}/\text{m}^2$     (c)  $0.062 \text{ N}\cdot\text{s}/\text{m}^2$     (d)  $0.0049 \text{ N}\cdot\text{s}/\text{m}^2$   
 (e)  $0.56 \text{ N}\cdot\text{s}/\text{m}^2$

Answer (e)  $0.56 \text{ N}\cdot\text{s}/\text{m}^2$

**Solution** Solved by EES Software. Solutions can be verified by copying-and-pasting the following lines on a blank EES screen. (Similar problems and their solutions can be obtained easily by modifying numerical values).

```
L=0.3 [m]
R=0.045 [m]
gap=0.0018 [m]
n_dot=(250/60) [1/s]
T=1.4 [N-m]
mu=(T*gap)/(4*pi^2*R^3*n_dot*L)
```

## 2-150

A 0.6-mm-diameter glass tube is inserted into water at  $20^\circ\text{C}$  in a cup. The surface tension of water at  $20^\circ\text{C}$  is  $\sigma_s = 0.073 \text{ N/m}$ . The contact angle can be taken as zero degrees. The capillary rise of water in the tube is

- (a) 2.6 cm    (b) 7.1 cm    (c) 5.0 cm    (d) 9.7 cm    (e) 12.0 cm

Answer (c) 5.0 cm

**Solution** Solved by EES Software. Solutions can be verified by copying-and-pasting the following lines on a blank EES screen. (Similar problems and their solutions can be obtained easily by modifying numerical values).

```
D=0.0006 [m]
R=D/2
sigma_s=0.073 [N/m]
phi=0 [degrees]
rho=1000 [kg/m^3]
g=9.81 [m/s^2]
h=(2*sigma_s*cos(phi))/(rho*g*R)
```

## 2-151

A liquid film suspended on a U-shaped wire frame with a 6-cm-long movable side is used to measure the surface tension of a liquid. If the force needed to move the wire is 0.028 N, the surface tension of this liquid in air is

- (a) 0.00762 N/m (b) 0.096 N/m (c) 0.168 N/m (d) 0.233 N/m (e) 0.466 N/m

Answer (d) 0.233 N/m

**Solution** Solved by EES Software. Solutions can be verified by copying-and-pasting the following lines on a blank EES screen. (Similar problems and their solutions can be obtained easily by modifying numerical values).

```
F=0.028 [N]
b=0.06 [m]
sigma_s=F/(2*b)
```

## 2-152

It is observed that water at 20°C solution rises up to 20 m height in a tube due to capillary effect. The surface tension of water at 20°C is  $\sigma_s = 0.073$  N/m and the contact angle is 20°. The maximum diameter of the tube in which water rises is

- (a) 0.035 mm (b) 0.016 mm (c) 0.02 mm (d) 0.002 mm (e) 0.0014 mm

Answer (e) 0.0014 mm

**Solution** Solved by EES Software. Solutions can be verified by copying-and-pasting the following lines on a blank EES screen. (Similar problems and their solutions can be obtained easily by modifying numerical values).

```
h=20 [m]
sigma_s=0.073 [N/m]
phi=20 [degrees]
rho=1000 [kg/m^3]
g=9.81 [m/s^2]
h=(2*sigma_s*cos(phi))/(rho*g*R)
D=2*R
```

---

**Design and Essay Problems**

---

**2-153 to 2-158**

**Solution**      Students' essays and designs should be unique and will differ from each other.

---

---

## 2-157

**Solution** We are to determine the inlet water speed at which cavitation is likely to occur in the throat of a converging-diverging tube or duct, and repeat for a higher temperature.

**Assumptions** 1 The fluid is incompressible and Newtonian. 2 Gravitational effects are negligible. 3 Irreversibilities are negligible. 4 The equations provided are valid for this flow.

**Properties** For water at 20°C,  $\rho = 998.0 \text{ kg/m}^3$  and  $P_{\text{sat}} = 2.339 \text{ kPa}$ .

**Analysis** (a) Two equations are given for velocity, pressure, and cross-sectional area, namely,

$$V_1 A_1 = V_2 A_2 \quad \text{and} \quad P_1 + \rho \frac{V_1^2}{2} = P_2 + \rho \frac{V_2^2}{2}$$

Solving the first equation for  $V_2$  gives

$$V_2 = V_1 \frac{A_1}{A_2} \tag{1}$$

Substituting the above into the equation for pressure and solving for  $V_1$  yields, after some algebra,

$$V_1 = \sqrt{\frac{2(P_1 - P_2)}{\rho \left[ \left( \frac{A_1}{A_2} \right)^2 - 1 \right]}}$$

But the pressure at which cavitation is likely to occur is the vapor (saturation) pressure of the water. We also know that throat diameter  $D_2$  is 1/20 times the inlet diameter  $D_1$ , and since  $A = \pi D^2/4$ ,  $A_1/A_2 = (20)^2 = 400$ . Thus,

$$V_1 = \sqrt{\frac{2(20.803 - 2.339) \text{ kPa} \left( \frac{1000 \text{ N/m}^2}{\text{kPa}} \right) \left( \frac{1 \text{ kg} \cdot \text{m/s}^2}{\text{N}} \right)}{998.0 \frac{\text{kg}}{\text{m}^3} (400^2 - 1)}} = 0.015207 \frac{\text{m}}{\text{s}}$$

So, the minimum inlet velocity at which cavitation is likely to occur is **0.0152 m/s** (to three significant digits). The velocity at the throat is much faster than this, of course. Using Eq. (1),

$$V_t = V_1 \frac{A_1}{A_t} = V_1 \frac{\pi D_1^2}{\pi D_t^2} = V_1 \left( \frac{D_1}{D_t} \right)^2 = 0.015207 \left( \frac{20}{1} \right)^2 = 6.0828 \text{ m/s}$$

(b) If the water is warmer (50°C), the density reduces to 988.1 kg/m<sup>3</sup>, and the vapor pressure increases to 12.35 kPa. At these conditions,  $V_1 = \mathbf{0.0103 \text{ m/s}}$ . As might be expected, **at higher temperature, a lower inlet velocity is required to generate cavitation, since the water is warmer and already closer to its boiling point.**

**Discussion** Cavitation is usually undesirable since it leads to noise, and the collapse of the bubbles can be destructive. It is therefore often wise to design piping systems and turbomachinery to avoid cavitation.

## 2-158

**Solution** We are to explain how objects like razor blades and paper clips can float on water, even though they are much denser than water.

**Analysis** Just as some insects like water striders can be supported on water by surface tension, **surface tension is the key to explaining this phenomenon**. If we think of surface tension like a skin on top of the water, somewhat like a stretched piece of balloon, we can understand how something heavier than water pushes down on the surface, but the **surface tension forces counteract the weight (to within limits) by providing an upward force**. Since soap decreases surface tension, we expect that **it would be harder to float objects like this on a soapy surface**; with a high enough soap concentration, in fact, we would expect that the razor blade or paper clip could not float at all.

**Discussion** If the razor blade or paper clip is fully submerged (breaking through the surface tension), it sinks.

---